

TM9-2320-211-20-2-2

T.O.36A12-1C-422-1-2

TECHNICAL MANUAL

VOLUME 2 OF 3

PART 2 OF 2

TROUBLESHOOTING

ORGANIZATIONAL LEVEL

5-TON, 6X6, M39 SERIES TRUCKS

(MULTIFUEL)

TRUCK, CHASSIS: M40A2C,

M61A2, M63A2; TRUCK, CARGO:

M54A2, M54A2C, M55A2; TRUCK,

DUMP: M51A2; TRUCK, TRACTOR:

M52A2; TRUCK, WRECKER, MEDIUM: M543A2

NOTE:

THE STYLE OF THIS TM IS
EXPERIMENTAL. IT IS BEING TRIED
BY THE ARMY ONLY ON
A LIMITED BASIS

DEPARTMENTS OF THE ARMY AND THE AIR FORCE

DECEMBER 1980

WARNING

EXHAUST GASES CAN BE DEADLY

Exposure to exhaust gases produces symptoms of headache, dizziness, loss of muscular control, apparent drowsiness, and coma. Permanent brain damage or death can result from severe exposure.

Carbon monoxide occurs in the exhaust fumes of fuel burning heaters and internal combustion engines, and becomes dangerously concentrated under conditions of inadequate ventilation. The following precautions must be observed to insure the safety of personnel whenever fuel burning heater(s) or engine of any vehicle is operated for maintenance purposes or tactical use.

Do not operate heater or engine of vehicle in an enclosed area unless it is adequately ventilated.

Do not idle engine for long periods without maintaining adequate ventilation in personnel compartments.

Do not drive any vehicle with inspection plates or cover plates removed unless necessary for maintenance purposes.

If exposed, seek prompt medical attention for possible delayed onset of acute lung congestion. Administer oxygen if available.

The best defense against exhaust gas poisoning is adequate ventilation.

WARNING

Serious or fatal injury to personnel may result if the following instructions are not complied with.

Use extreme care when removing radiator cap, especially when temperature gage shows above 180°F.

Always wear leather gloves when handling winch cable. Never allow cable to slip through hands. Do not operate winch with less than four turns of cable on drum.

Do not drive truck until the low air pressure warning buzzer is silent and the air pressure gage shows at least 65 PSI. This is the minimum pressure required for safe braking action.

Do not use hand throttle to drive the vehicle.

Do not park truck with front transmission gearshift level in gear.

When used to carry flammables, explosives, or other hazardous material, equip truck with a fire extinguisher.

If your vehicle class number is greater than the bridge class number, your vehicle is too heavy for the bridge; DO NOT CROSS.

WARNING - Cont

Dry cleaning solvent is flammable. Do not use near an open flame. Keep a fire extinguisher nearby when solvent is used. Use only in well-ventilated places. Failure to do this may result in injury to personnel and damage to equipment.

Eye shields must be worn when using compressed air. Eye injury can occur if eye shields are not worn.

Diesel fuel is very flammable. Care must be used when choosing a place to work on fuel system. Keep truck about 50 feet away from an area where open flame, sparks or smoking may cause a fire. Keep a fire extinguisher close by.

TECHNICAL MANUAL
NO. 9-2320 -211-20-2-2
TECHNICAL ORDER
NO. 36A12-1C-422-1-2

DEPARTMENTS OF THE ARMY
AND
THE AIR FORCE
WASHINGTON, DC. 10 December 1980

TECHNICAL MANUAL
VOLUME 2 OF 3
PART 2 OF 2
TROUBLESHOOTING
ORGANIZATIONAL LEVEL

5-TON, 6X6, M39 SERIES TRUCKS
(MULTIFUEL)

Model		NSN without Winch	NSN with Winch
Chassis	M40A2C	2320-00-969-4114	
	M61A2	2320-00-055-9264	2320-00-965-0321
	M63A2	2320-00-226-6251	2320-00-285-3757
Truck, Cargo	M54A2	2320-00-055-9266	2320-00-055-9265
	M54A2C	2320-00-926-0874	2320-00-926-0874
	M55A2	2320-00-073-8476	2320-00-055-9259
Truck, Dump	M51A2	2320-00-055-9262	2320-00-055-9263
Truck, Tractor	M52A2	2320-00-055-9260	2320-00-055-9261
Truck, Wrecker, Medium	M543A2		2320-00-055-9258

*This manual together with TM 9-2320-211.20-1, 10 December 1980; TM 9-2320-211-20-2-1, 10 December 1980; TM 9-2320-211-20-3-1, 10 December 1980 and TM 9-2320-211-20-3-2, 10 December 1980 supersedes so much of TM 9-2320-211-20, 1 June 1973 as pertains to multifuel vehicles including all changes.

REPORTING OF ERRORS AND RECOMMENDING IMPROVEMENTS

You can help improve this manual. If you find any mistakes or if you know of a way to improve the procedure, please let us know. Mail your letter, DA Form 2028 (Recommended Changes to Publication and Blank Forms) , or DA Form 2028-2 located in the back of this manual direct to: Commander, U.S. Army Tank Automotive Materiel Readiness Command, ATTN: DRSTA-MB, Warren, Michigan 48090. A reply will be furnished to you.

		Paragraph	Page
CHAPTER 27.	ELECTRICAL SYSTEM TROUBLESHOOTING SUMMARY		
	General	27-1	27-1
	Procedures	27-2	27-1
28.	ELECTRICAL SYSTEM SUPPORT DIAGRAMS		
	General	28-1	28-1
29.	ELECTRICAL SYSTEM TEST PROCEDURES		
	General	29-1	29-1
	Test Set-Up	29-2	29-1
	Test Procedures	29-3	29-1
30.	ELECTRICAL SYSTEM OPERATING AND PRELIMINARY PROCEDURES		
	Equipment Items Covered	30-1	30-1
	Equipment Items Not Covered	30-2	30-1
31.	ELECTRICAL SYSTEM CHECKOUT PROCEDURES		
	General	31-1	31-1
32.	TRANSMISSION SYSTEM TROUBLESHOOTING		
	Equipment Items Covered	32-1	32-1
	Equipment Items Not Covered	32-2	32-1
33.	TRANSFER SYSTEM TROUBLESHOOTING		
	Equipment Items Covered	33-1	33-1
	Equipment Items Not Covered	33-2	33-1
34.	TRANSFER SYSTEM TROUBLESHOOTING SUMMARY		
	General	34-1	34-1
	Procedures	34-2	34-1
35.	TRANSFER SYSTEM SUPPORT DIAGRAMS		
	General	35-1	35-1
36.	TRANSFER SYSTEM CHECKOUT PROCEDURES		
	General	36-1	36-1
37.	PROPELLER SHAFT SYSTEM TROUBLESHOOTING		
	Equipment Items Covered	37-1	37-1
	Equipment Items Not Covered	37-2	37-1

	Paragraph	Page
CHAPTER 38. PROPELLER SHAFT SYSTEM TROUBLE-		
SHOOTING SUMMARY		
General	38-1	38-1
Procedures	38-2	38-1
39. PROPELLER SHAFT SYSTEM SUPPORT		
DIAGRAMS		
General	39-1	39-1
40. FRONT AXLE SYSTEM TROUBLESHOOTING		
Equipment Items Covered	40-1	40-1
Equipment Items Not Covered	40-2	40-1
41. FRONT AXLE SYSTEM TROUBLESHOOTING		
SUMMARY		
General	41-1	41-1
Procedures	41-2	41-1
42. FRONT AXLE SYSTEM CHECKOUT PROCEDURES		
General	42-1	42-1
43. REAR AXLE SYSTEM TROUBLESHOOTING		
Equipment Items Covered	43-1	43-1
Equipment Items Not Covered	43-2	43-1
44. REAR AXLE SYSTEM TROUBLESHOOTING		
SUMMARY		
General	44-1	44-1
Procedures	44-2	44-1
45. REAR AXLE SYSTEM CHECKOUT PROCEDURES		
General	45-1	45-1
46. BRAKE SYSTEM TROUBLESHOOTING		
Equipment Items Covered	46-1	46-1
Equipment Items Not Covered	46-2	46-1
47. BRAKE SYSTEM TROUBLESHOOTING		
SUMMARY		
General	47-1	47-1
Procedures	47-2	47-1
48. BRAKE SYSTEM SUPPORT DIAGRAMS		
General	48-1	48-1
49. BRAKE SYSTEM TEST PROCEDURES		
General	49-1	49-1
Test Set-Up	49-2	49-1
Test Procedure	49-3	49-1
50. BRAKE SYSTEM CHECKOUT PROCEDURES		
General	50-1	50-1
51. WHEEL SYSTEM TROUBLESHOOTING		
Equipment Items Covered	51-1	51-1
Equipment Items Not Covered	51-2	51-1
52. WHEEL SYSTEM TROUBLESHOOTING SUMMARY		
General	52-1	52-1
Procedures	52-2	52-1
53. WHEEL SYSTEM CHECKOUT PROCEDURES		
General	53-1	53-1

CHAPTER 54.	STEERING SYSTEM TROUBLESHOOTING		
	Equipment Items Covered	54-1	54-1
	Equipment Items Not Covered	54-2	54-1
55.	STEERING SYSTEM TROUBLESHOOTING SUMMARY		
	General	55-1	55-1
	Procedures	55-2	55-1
56.	STEERING SYSTEM SUPPORT DIAGRAMS		
	General	56-1	56-1
57.	STEERING SYSTEM CHECKOUT PROCEDURES		
	General	57-1	57-1
58.	SPRING AND SHOCK ABSORBER SYSTEM TROUBLESHOOTING		
	Equipment Items Covered	58-1	58-1
	Equipment Items Not Covered	58-2	58-1
59.	SPRING AND SHOCK ABSORBER SYSTEM TROUBLESHOOTING SUMMARY		
	General	59-1	59-1
	Procedures	59-2	59-1
60.	FRONT WINCH TROUBLESHOOTING		
	Equipment Items Covered	60-1	60-1
	Equipment Items Not Covered	60-2	60-1
61.	FRONT WINCH TROUBLESHOOTING SUMMARY		
	General	61-1	61-1
	Procedures	61-2	61-1
62.	FRONT WINCH CHECKOUT PROCEDURES		
	General	62-1	62-1
63.	DUMP BODY AND HOIST SYSTEM TROUBLESHOOTING		
	Equipment Items Covered	63-1	63-1
	Equipment Items Not Covered	63-2	63-1
64.	DUMP BODY AND HOIST SYSTEM TROUBLESHOOTING SUMMARY		
	General	64-1	64-1
	Procedures	64-2	64-1
65.	DUMP BODY AND HOIST SYSTEM SUPPORT DIAGRAMS		
	General	65-1	65-1
66.	DUMP BODY AND HOIST SYSTEM TEST PROCEDURES		
	General	66-1	66-1
	Test Set-Up	66-2	66-1
	Test Procedures	66-3	66-1
67.	DUMP BODY AND HOIST SYSTEM CHECKOUT PROCEDURES		
	General	67-1	67-1
68.	REAR WINCH TROUBLESHOOTING		
	Equipment Items Covered	68-1	68-1
	Equipment Items Not Covered	68-2	68-1

	Paragraph	Page
CHAPTER 69. REAR WINCH TROUBLESHOOTING SUMMARY		
General	69-1	69-1
Procedures	69-2	69-1
70. REAR WINCH SUPPORT DIAGRAMS		
General	70-1	70-1
71. REAR WINCH CHECKOUT PROCEDURES		
General	71-1	71-1
72. WRECKER SYSTEM TROUBLESHOOTING		
Equipment Items Covered	72-1	72-1
Equipment Items Not Covered	72-2	72-1
73. WRECKER SYSTEM TROUBLESHOOTING SUMMARY		
General	73-1	73-1
Procedures	73-2	73-1
74. WRECKER SYSTEM SUPPORT DIAGRAMS		
General	74-1	74-1
75. WRECKER SYSTEM TEST PROCEDURES		
General	75-1	75-1
Test Set-Up	75-2	75-1
Test Procedure	75-3	75-1
76. WRECKER SYSTEM CHECKOUT PROCEDURES		
General	76-1	76-1
77. ENGINE COOLANT HEATER SYSTEM TROUBLESHOOTING		
Equipment Items Covered	77-1	77-1
Equipment Items Not Covered	77-2	77-1
78. ENGINE COOLANT HEATER SYSTEM TROUBLESHOOTING SUMMARY		
General	78-1	78-1
Procedures	78-2	78-1
79. ENGINE COOLANT HEATER SYSTEM TEST PROCEDURES		
General	79-1	79-1
Test Set-Up	79-2	79-1
Test Procedure	79-3	79-1
80. ENGINE COOLANT HEATER SYSTEM CHECKOUT PROCEDURES		
General	80-1	80-1
81. FUEL BURNING HEATER SYSTEM TROUBLESHOOTING		
Equipment Items Covered	81-1	81-1
Equipment Items Not Covered	81-2	81-1
82. FUEL BURNING HEATER SYSTEM TROUBLESHOOTING SUMMARY		
General	82-1	82-1
Procedures	82-2	82-1
83. FUEL BURNING HEATER SYSTEM CHECKOUT PROCEDURES		
General	83-1	83-1

	Paragraph	Page
CHAPTER 84. HOT WATER HEATER SYSTEM TROUBLE- SHOOTING		
Equipment Items Covered	84-1	84-1
Equipment Items Not Covered	84-2	84-1
85. HOT WATER HEATER SYSTEM TROUBLE- SHOOTING SUMMARY		
General	85-1	85-1
Procedures	85-2	85-1
86. HOT WATER HEATER SYSTEM CHECKOUT PROCEDURES		
General	86-1	86-1
87. NONELECTRICAL GAGES TROUBLESHOOTING		
Equipment Items Covered	87-1	87-1
Equipment Items Not Covered	87-2	87-1
88. NONELECTRICAL GAGES TROUBLESHOOTING SUMMARY		
General	88-1	88-1
Procedures	88-2	88-1
89. NONELECTRICAL GAGES SUPPORT DIAGRAMS		
General	89-1	89-1
90. NONELECTRICAL GAGES CHECKOUT PROCEDURES		
General	90-1	90-1

CHAPTER 27

ELECTRICAL SYSTEM TROUBLESHOOTING SUMMARY

27-1. GENERAL . This chapter gives a summary of troubleshooting procedures given in chapter 26, for the Electrical System.

27-2. PROCEDURES. The summary in this chapter covers all fault symptoms found in the detailed troubleshooting procedures. Chapter 7 outlines a sample troubleshooting procedure. The summary procedures are based on the "what-to-do" portions of the detailed procedures and do not include the "How-to-do-it" instructions. Warnings, cautions, and notes are given where needed.

NOTE

All references to TM 9-2320-211-10
apply to the 10 Series only.

ELECTRICAL SYSTEM - STARTER SYSTEM TROUBLESHOOTING SUMMARY

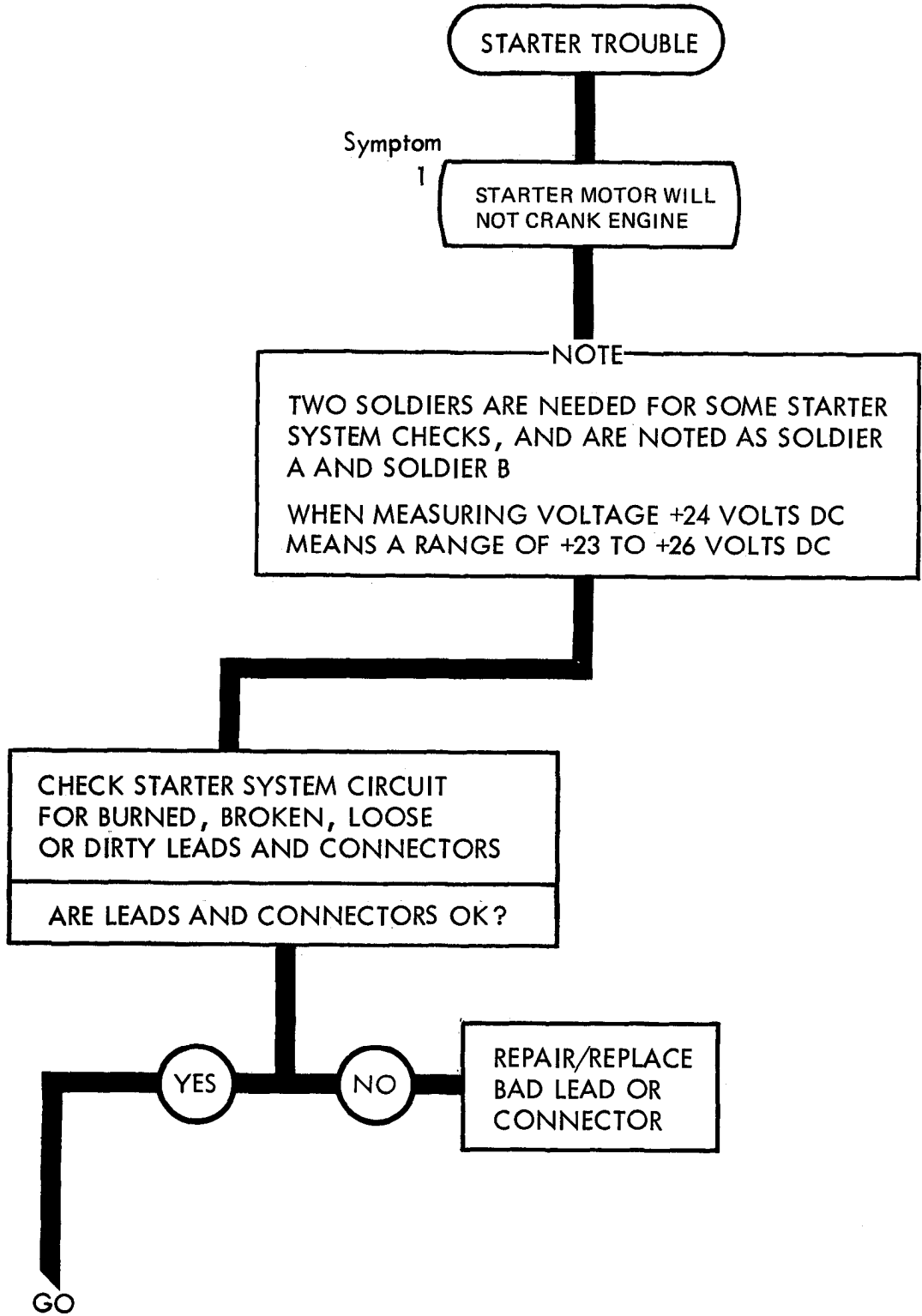
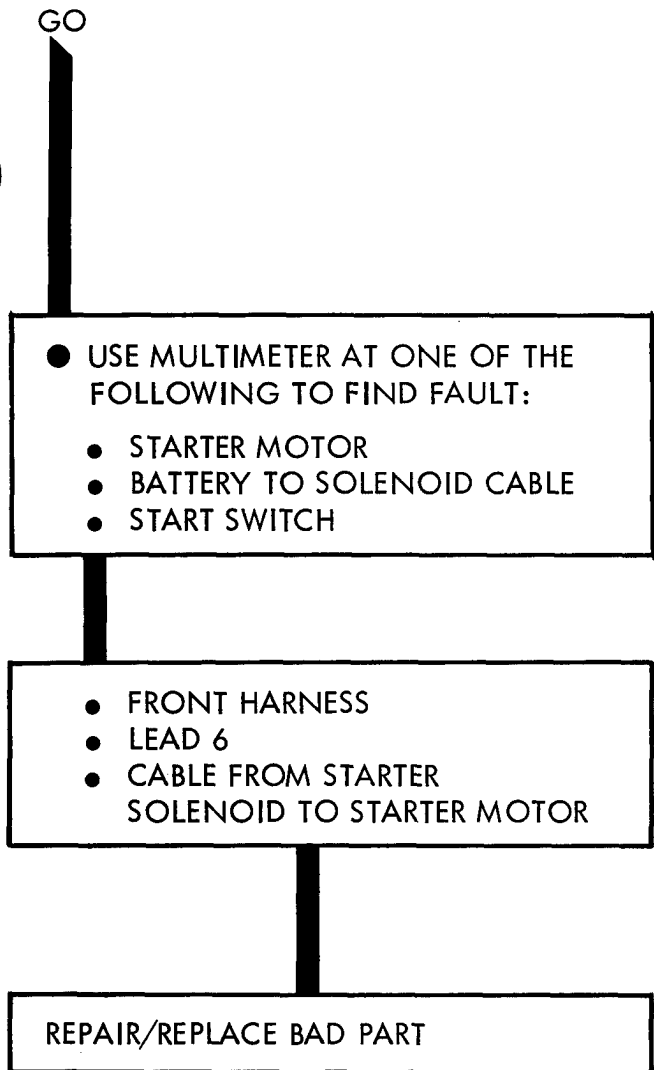

Figure 27-1 (Sheet 1 of 2)



NOTE: FOR DETAILED TROUBLESHOOTING PROCEDURES, SEE SYMPTOM INDEX

Figure 27-1 (Sheet 2 of 2)

ELECTRICAL SYSTEM - CHARGING SYSTEM TROUBLESHOOTING SUMMARY

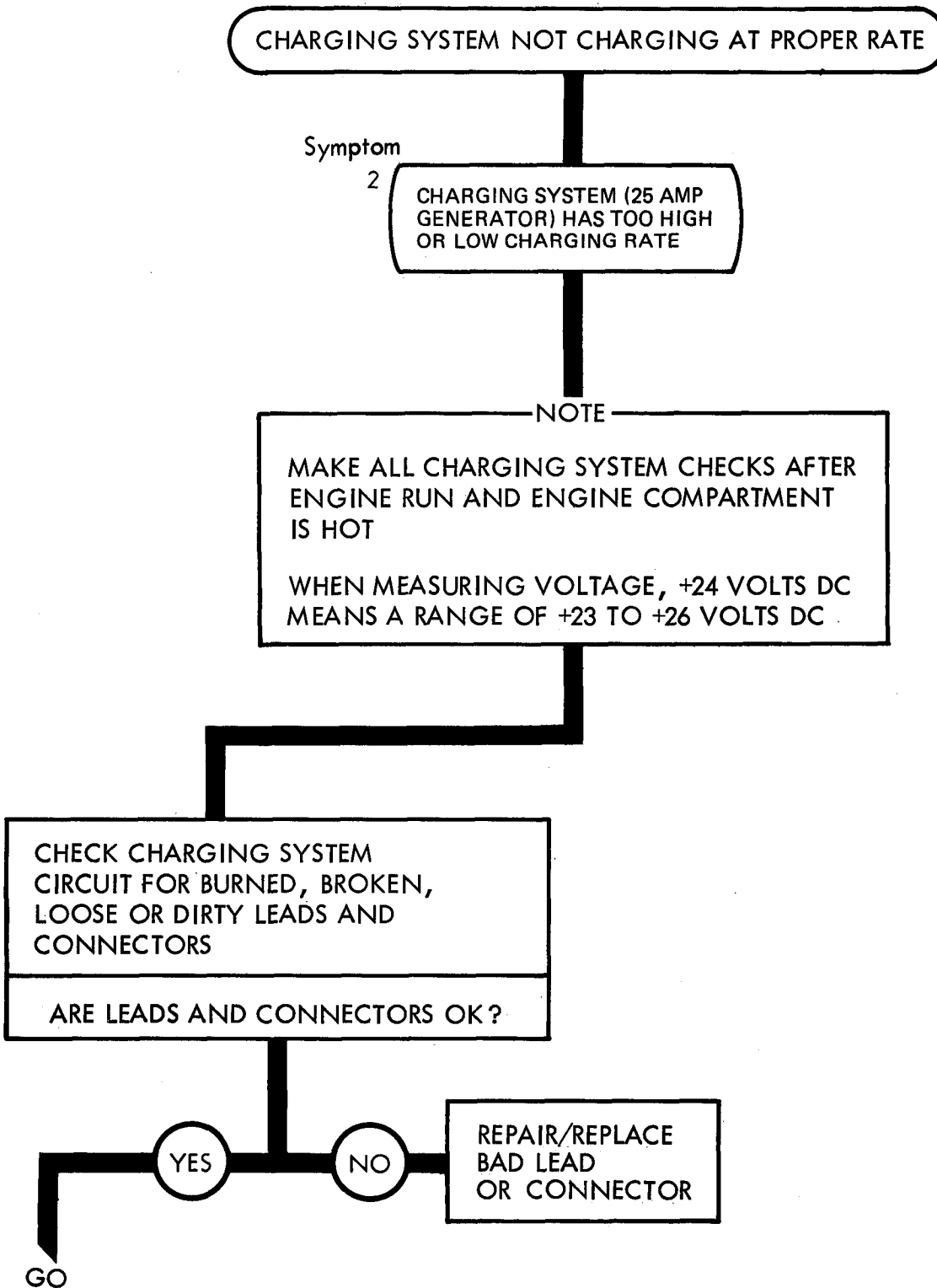
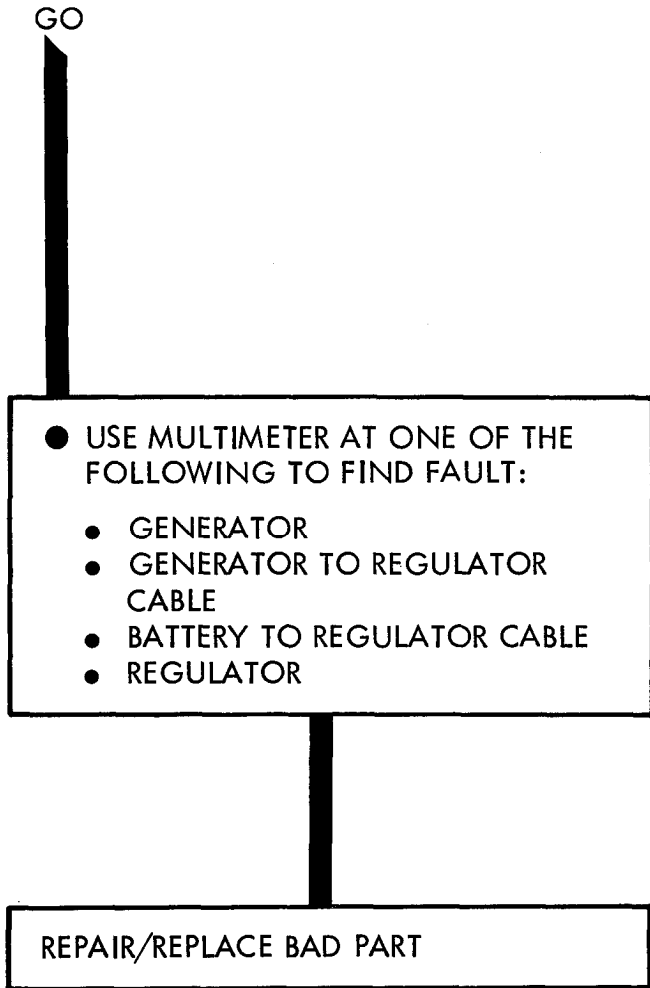

Figure 27-2 (Sheet 1 of 2)



NOTE: FOR DETAILED TROUBLESHOOTING PROCEDURES, SEE SYMPTOM INDEX

Figure 27-2 (Sheet 2 of 2)

ELECTRICAL SYSTEM - BATTERY SYSTEM TROUBLESHOOTING SUMMARY

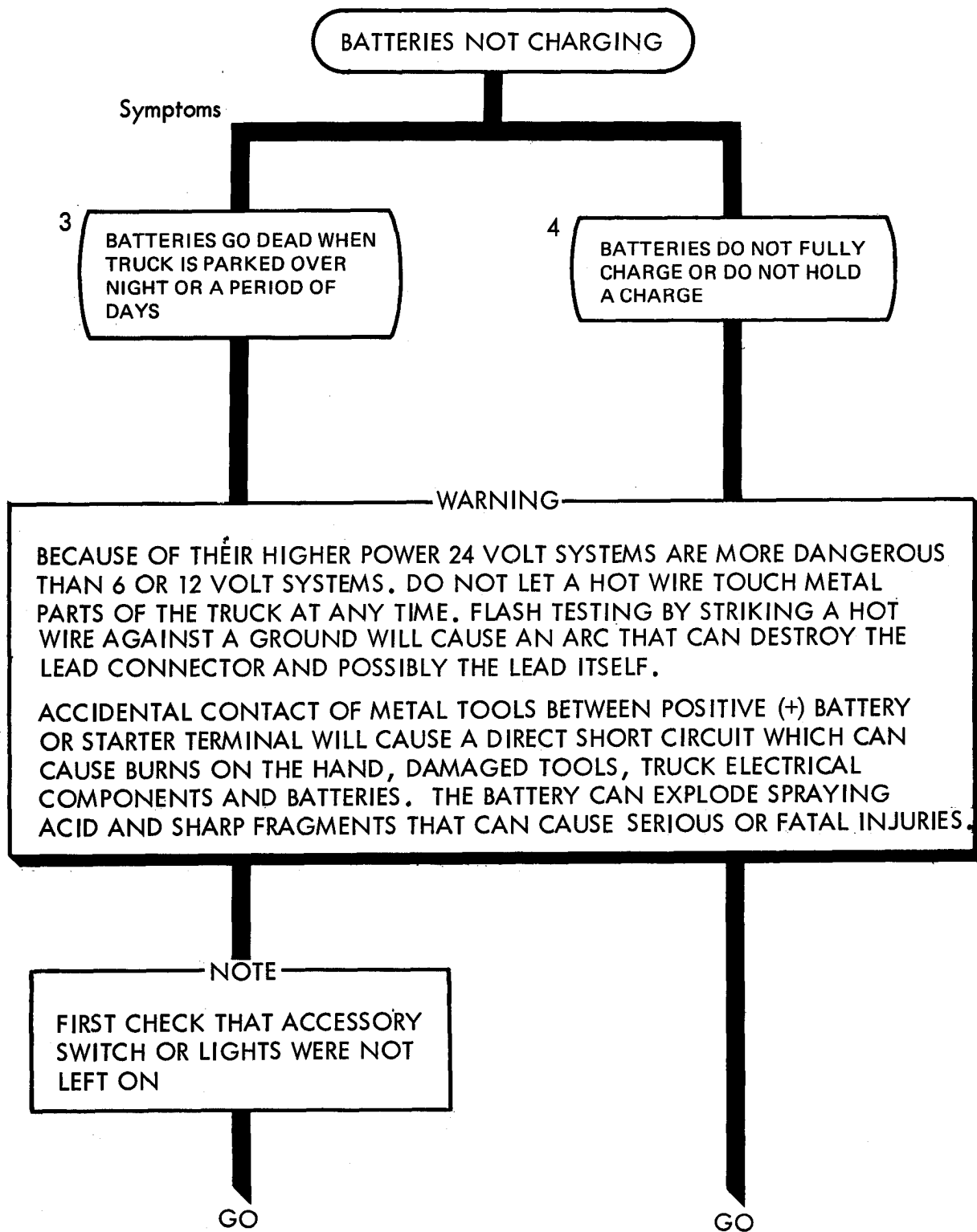
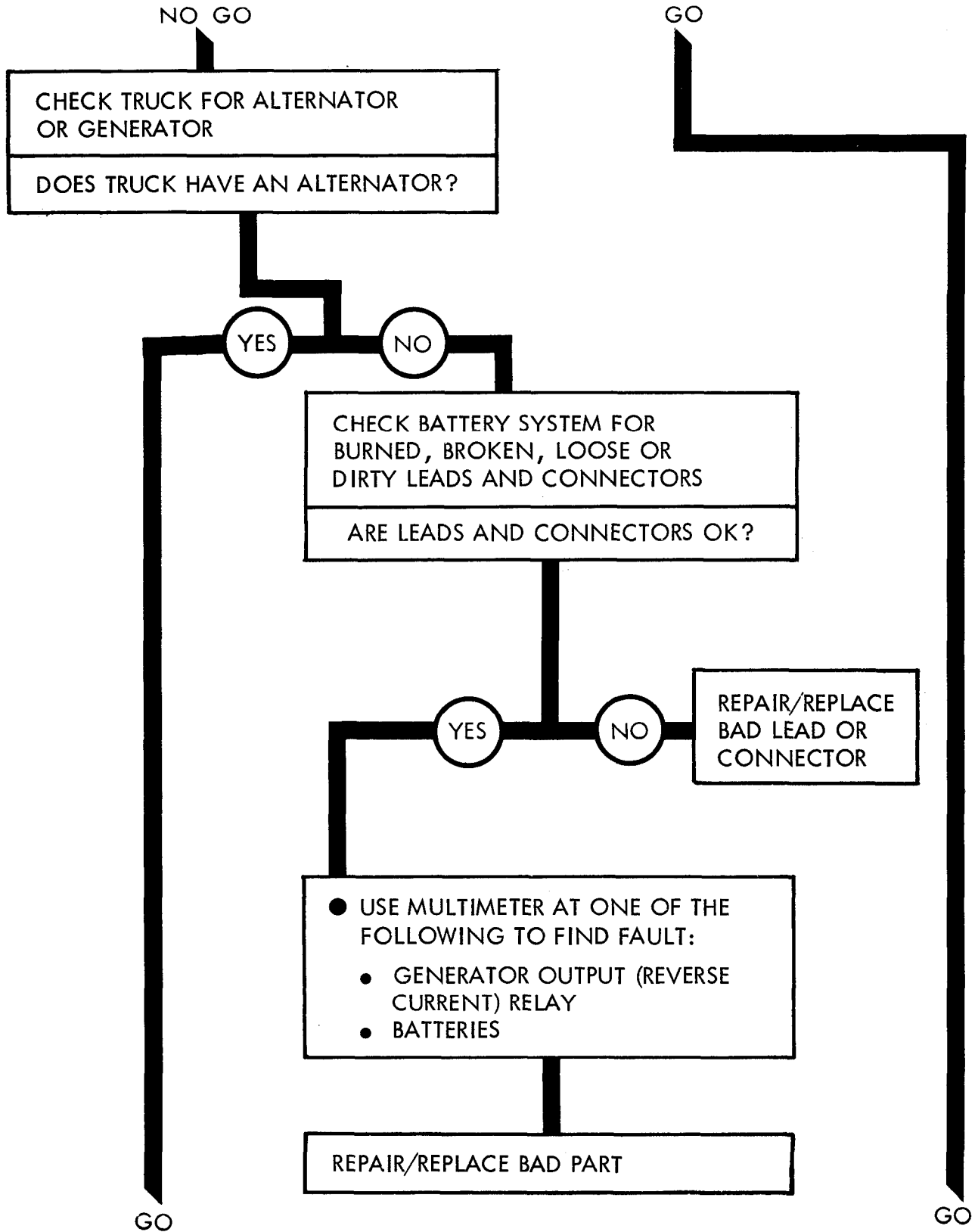
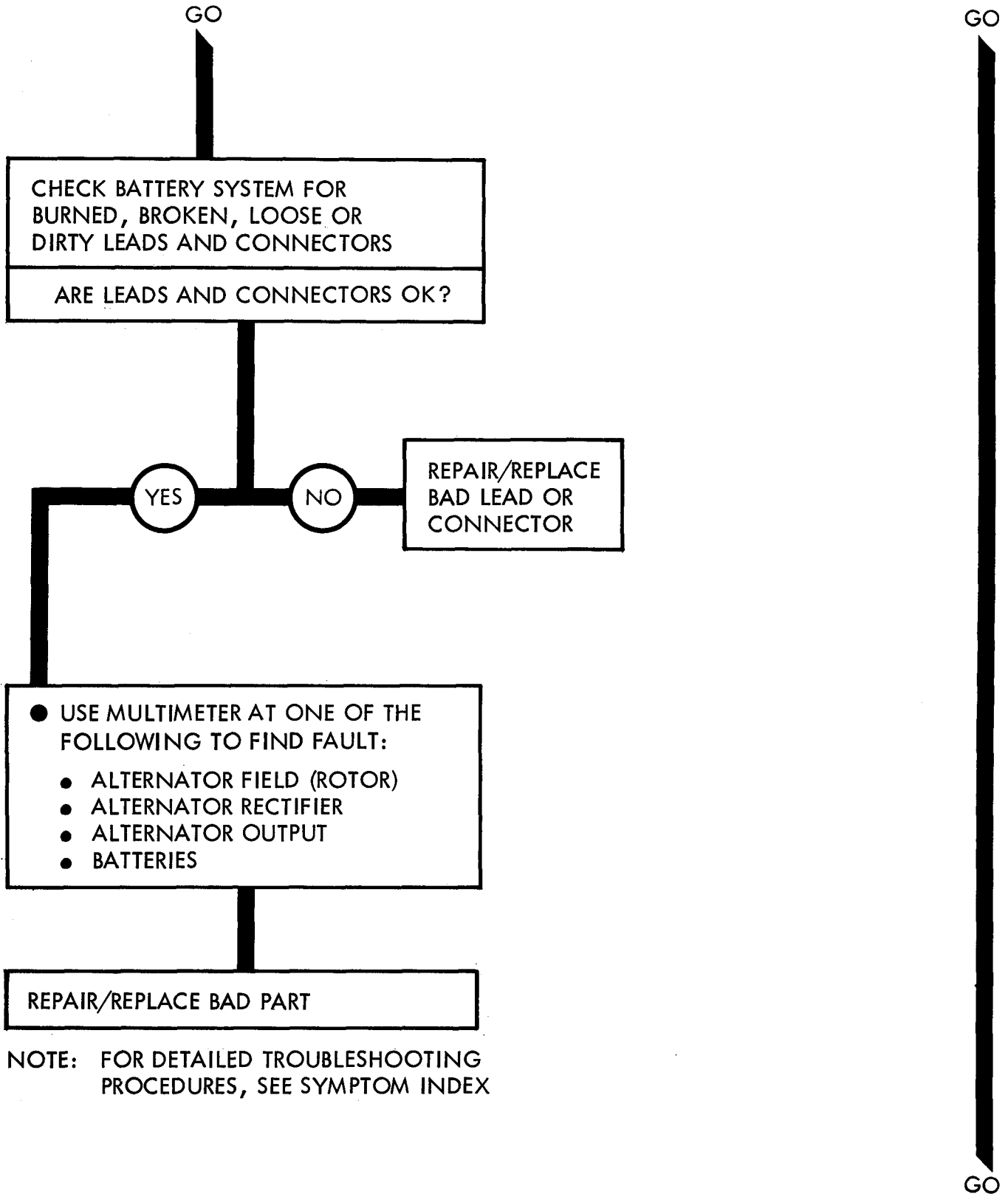

Figure 27-3 (Sheet 1 of 4)



TA 116024.

Figure 27--3 (Sheet 2 of 4)



NOTE: FOR DETAILED TROUBLESHOOTING PROCEDURES, SEE SYMPTOM INDEX

Figure 27-3 (Sheet 3 of 4)

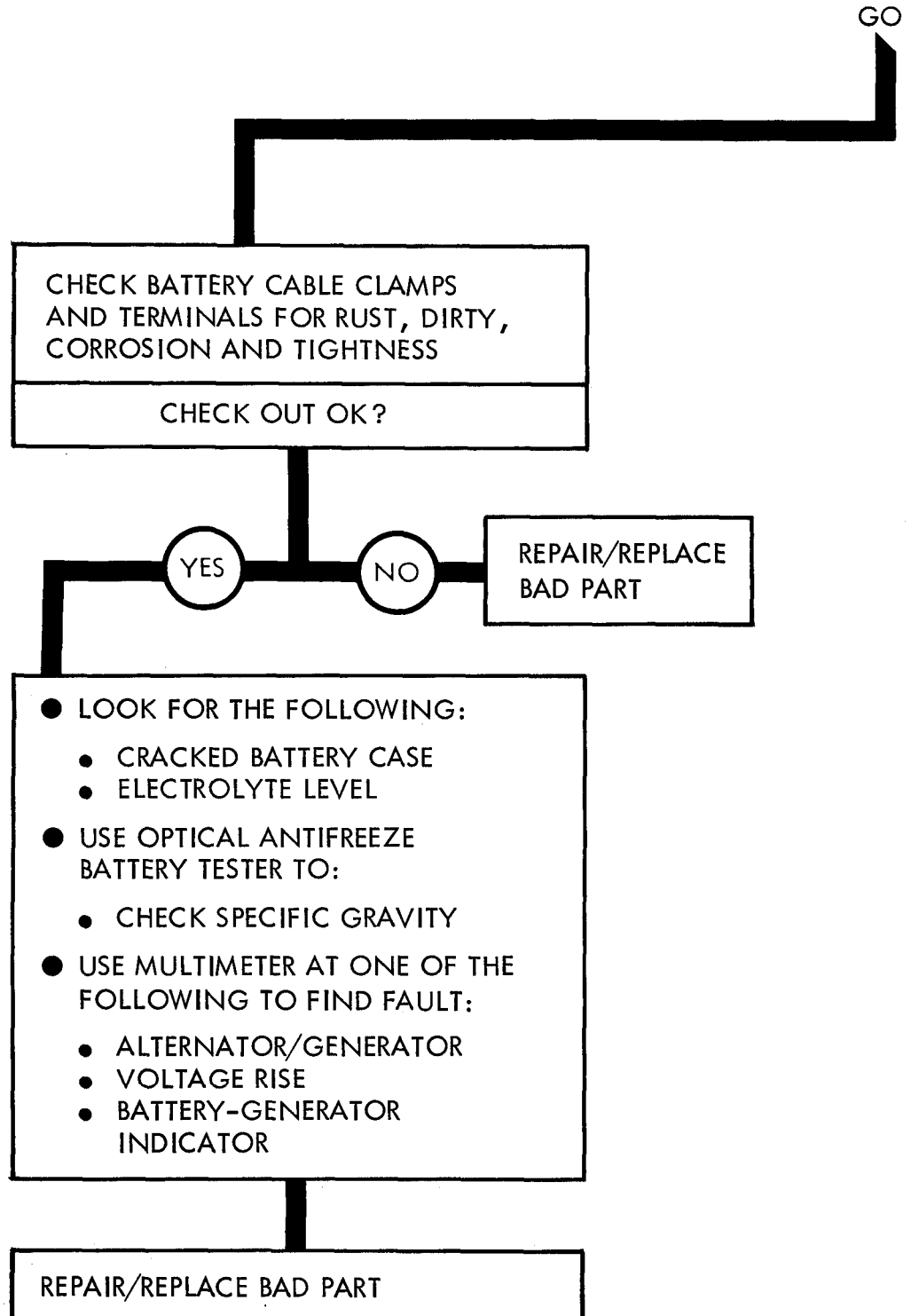

NOTE: FOR DETAILED TROUBLESHOOTING PROCEDURES, SEE SYMPTOM INDEX

Figure 27-3 (Sheet 4 of 4)

ELECTRICAL SYSTEM - LIGHTING SYSTEM TROUBLESHOOTING SUMMARY

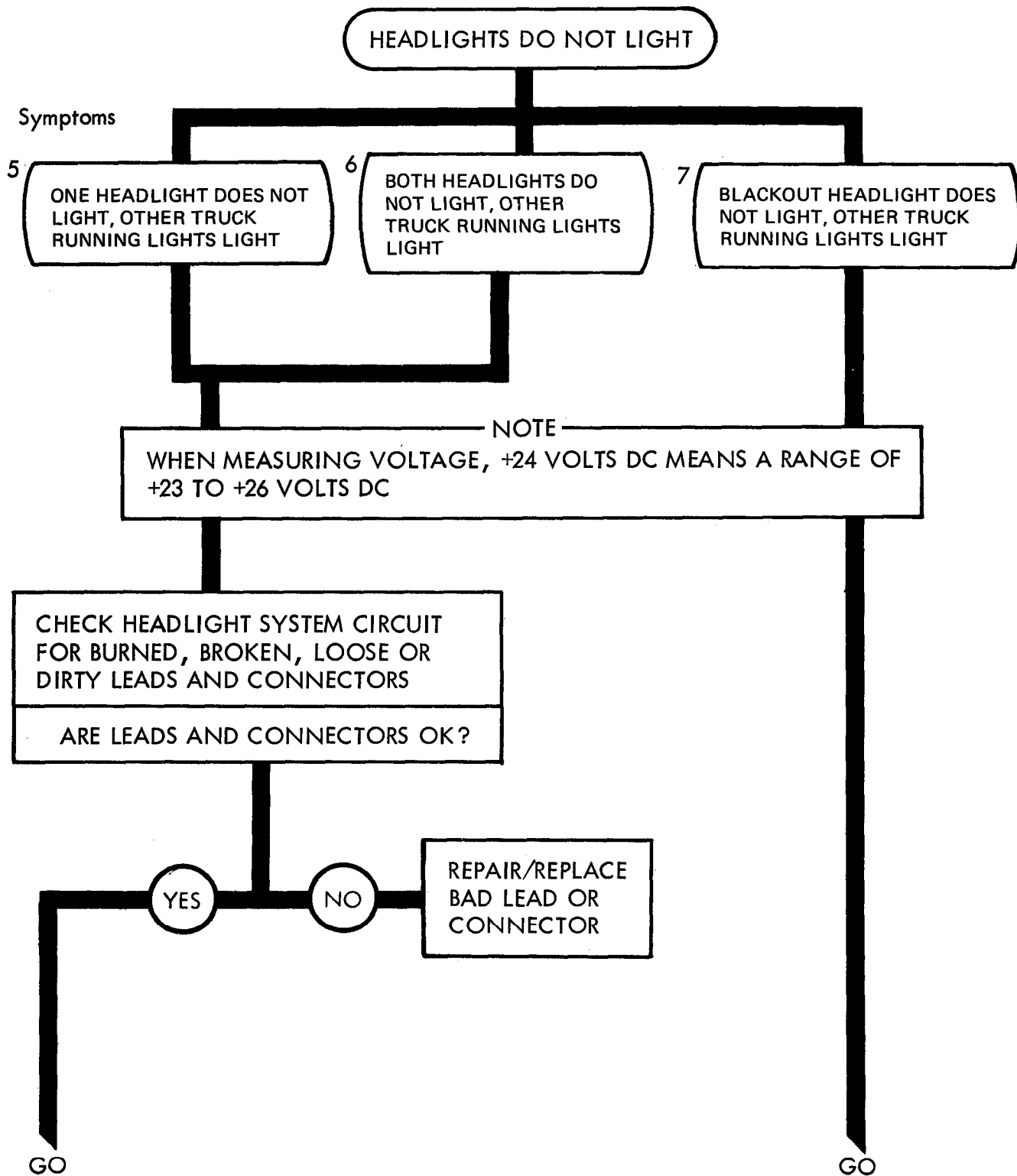
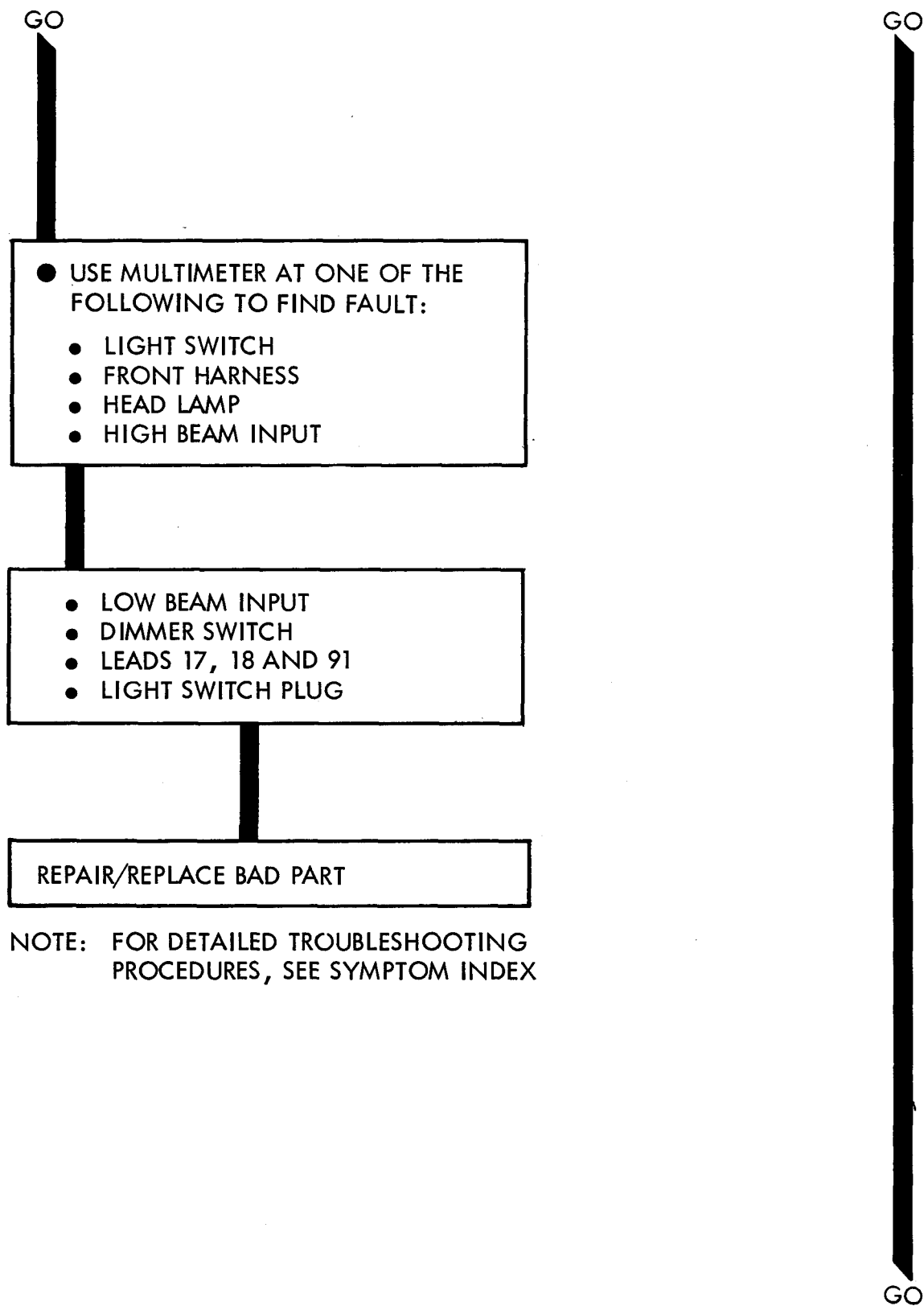
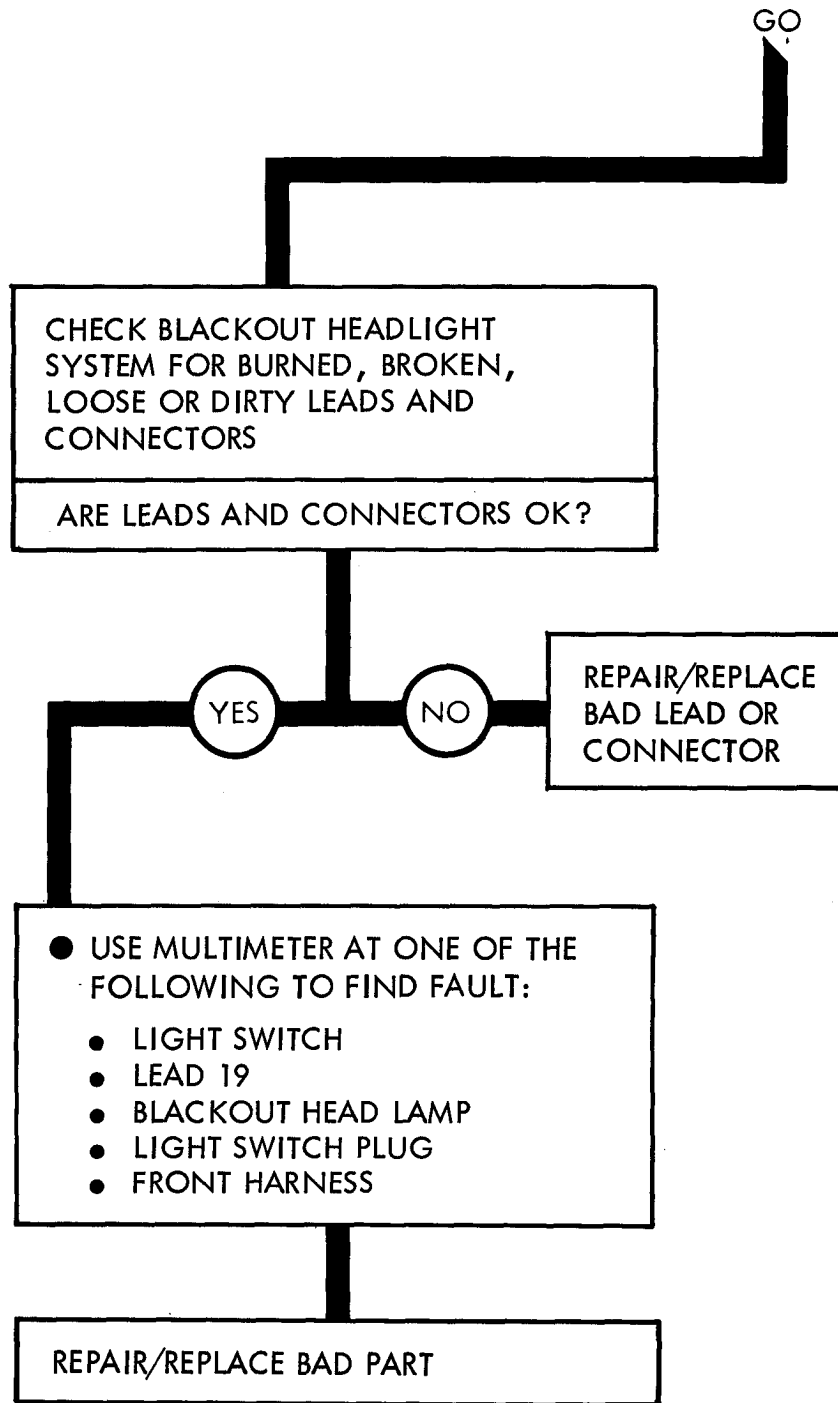

Figure 27-4 (Sheet 1 of 19)



NOTE: FOR DETAILED TROUBLESHOOTING PROCEDURES, SEE SYMPTOM INDEX



NOTE: FOR DETAILED TROUBLESHOOTING PROCEDURES, SEE SYMPTOM INDEX

Figure 27-4 (Sheet 3 of 19)

ELECTRICAL SYSTEM - LIGHTING SYSTEM TROUBLESHOOTING SUMMARY

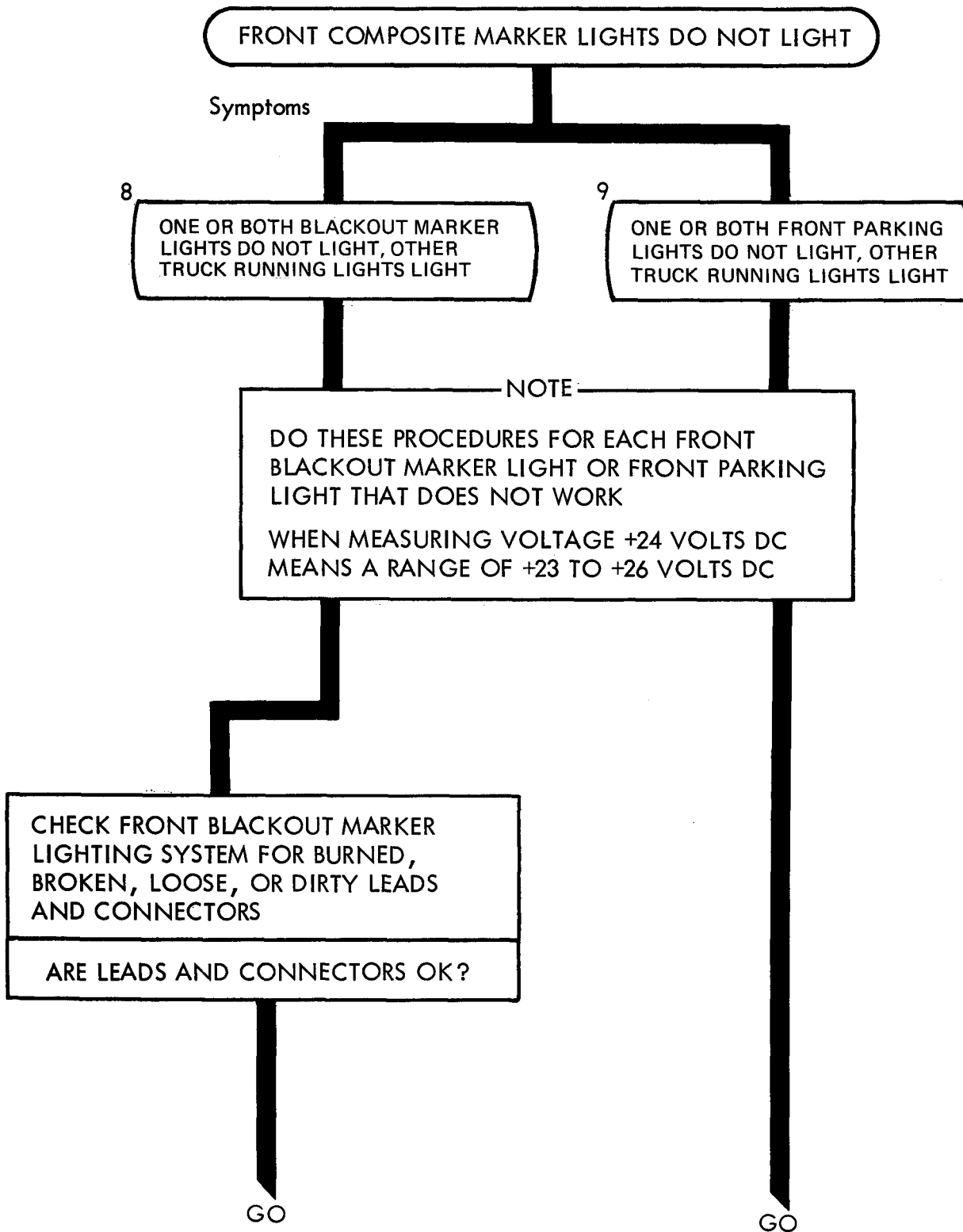
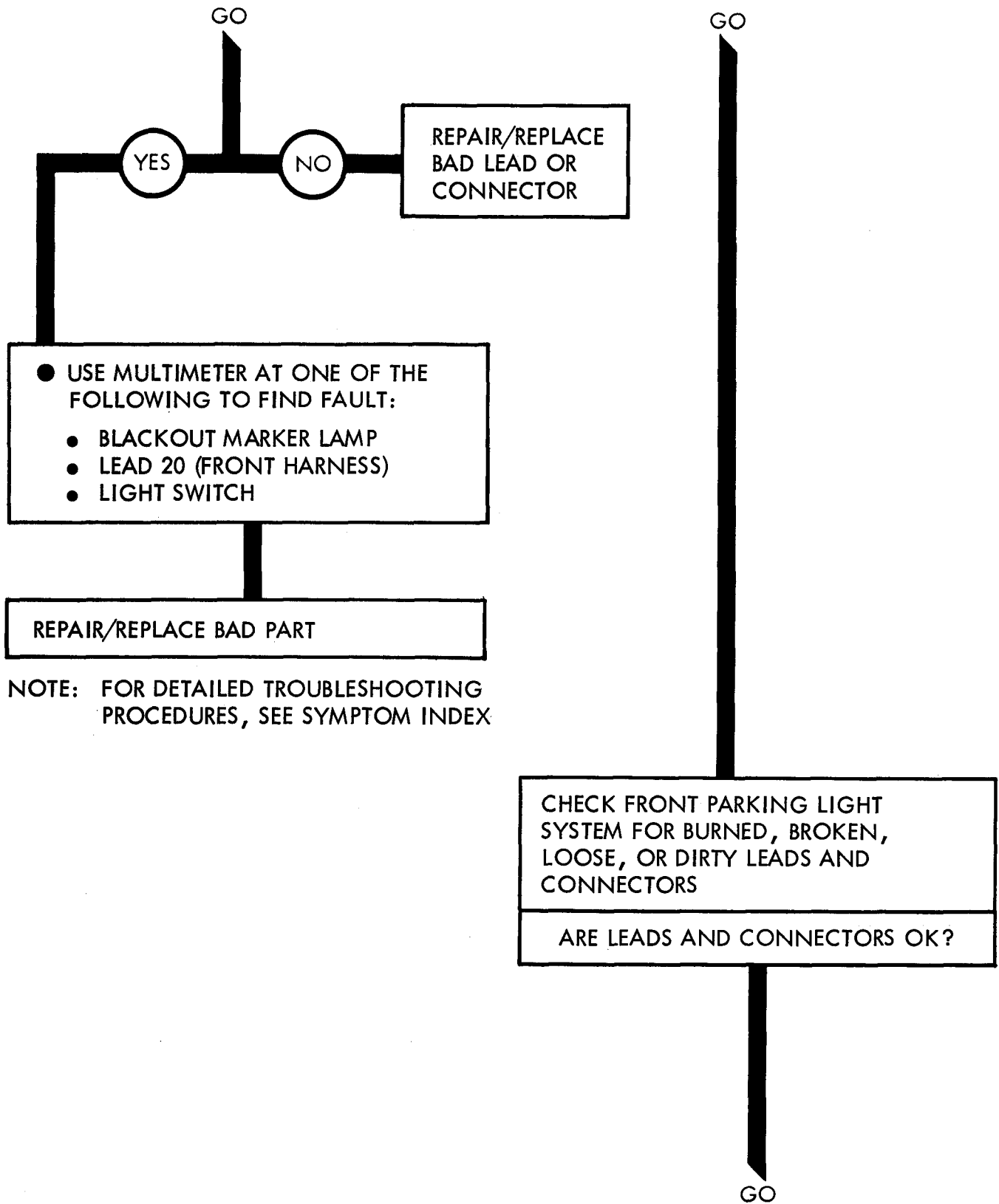

Figure 27-4 (Sheet 4 of 19)



NOTE: FOR DETAILED TROUBLESHOOTING PROCEDURES, SEE SYMPTOM INDEX

Figure 27-4 (Sheet 5 of 19)

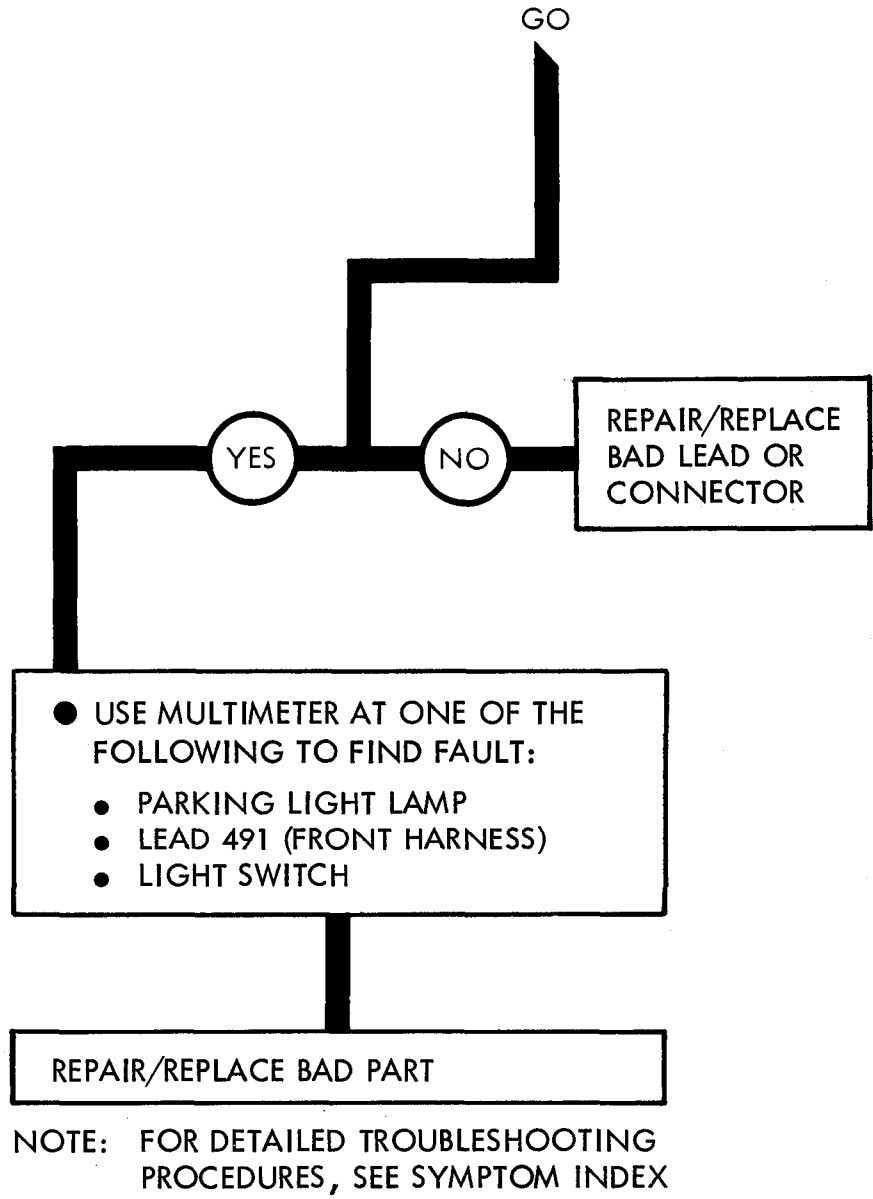

Figure 27-4 (Sheet 6 of 19)

ELECTRICAL SYSTEM - LIGHTING SYSTEM TROUBLESHOOTING SUMMARY

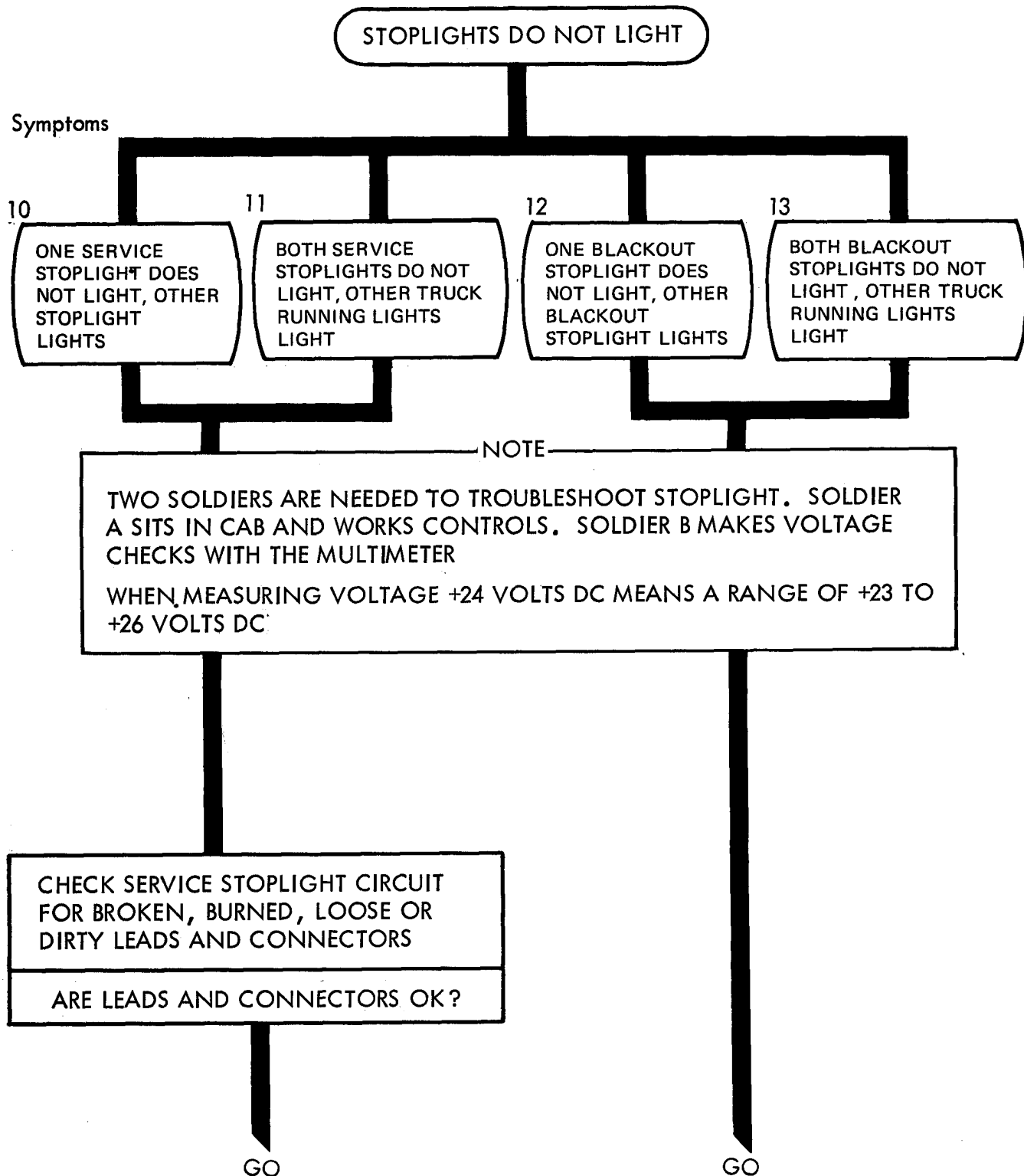

Figure 27-4 (Sheet 7 of 19)

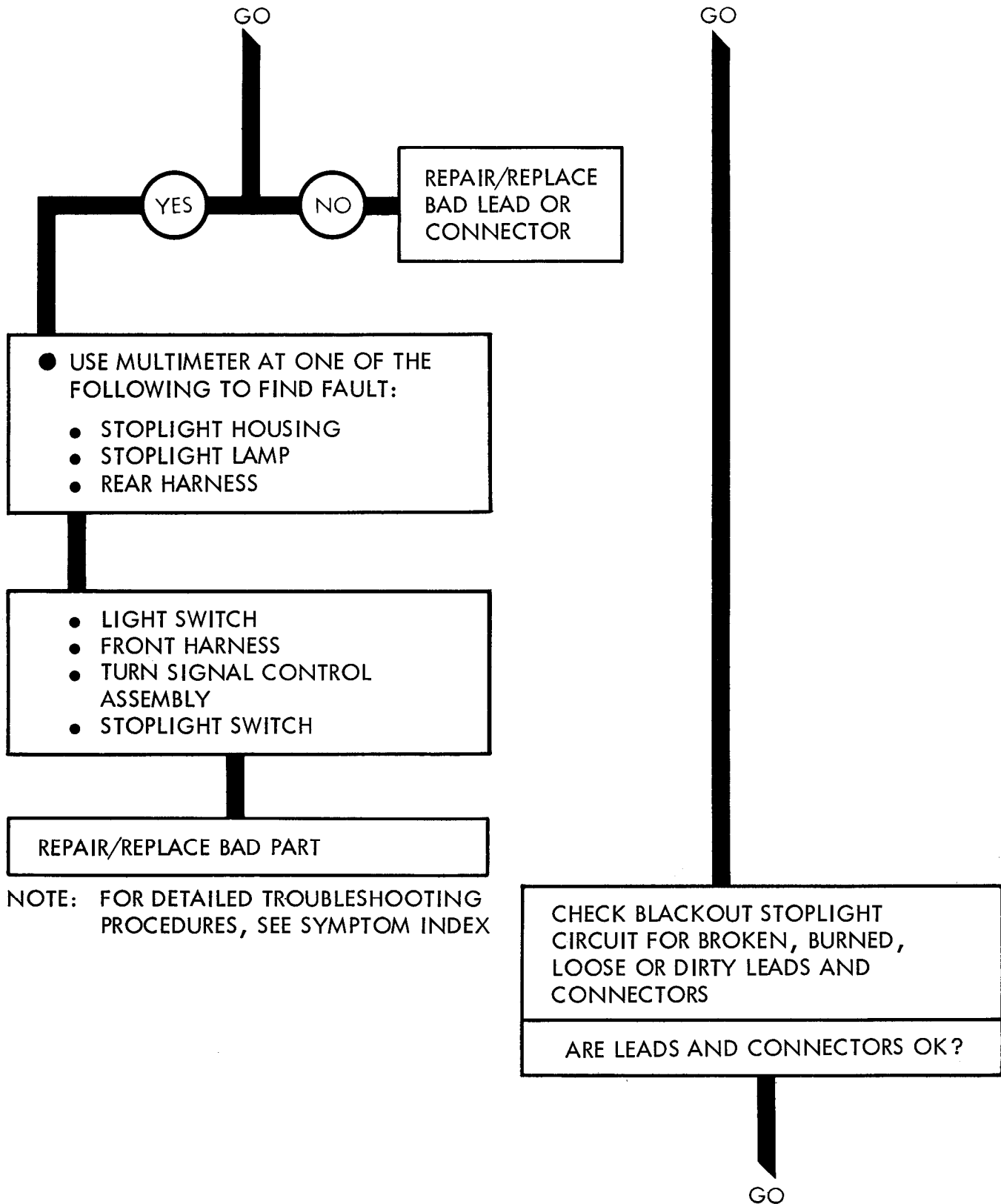

Figure 27-4 (Sheet 8 of 19)

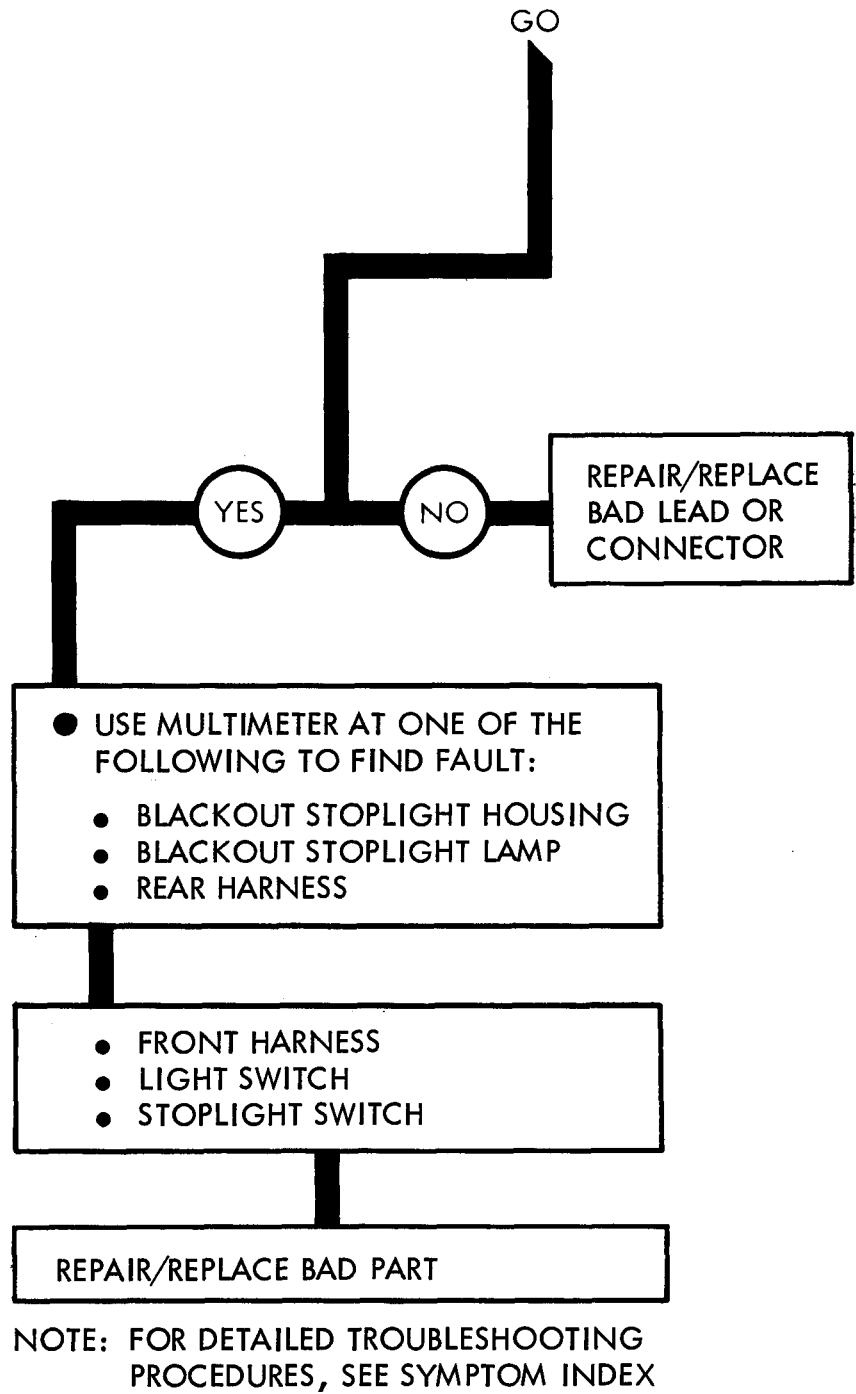

Figure 27-4 (Sheet 9 of 19)

ELECTRICAL SYSTEM - LIGHTING SYSTEM TROUBLESHOOTING SUMMARY

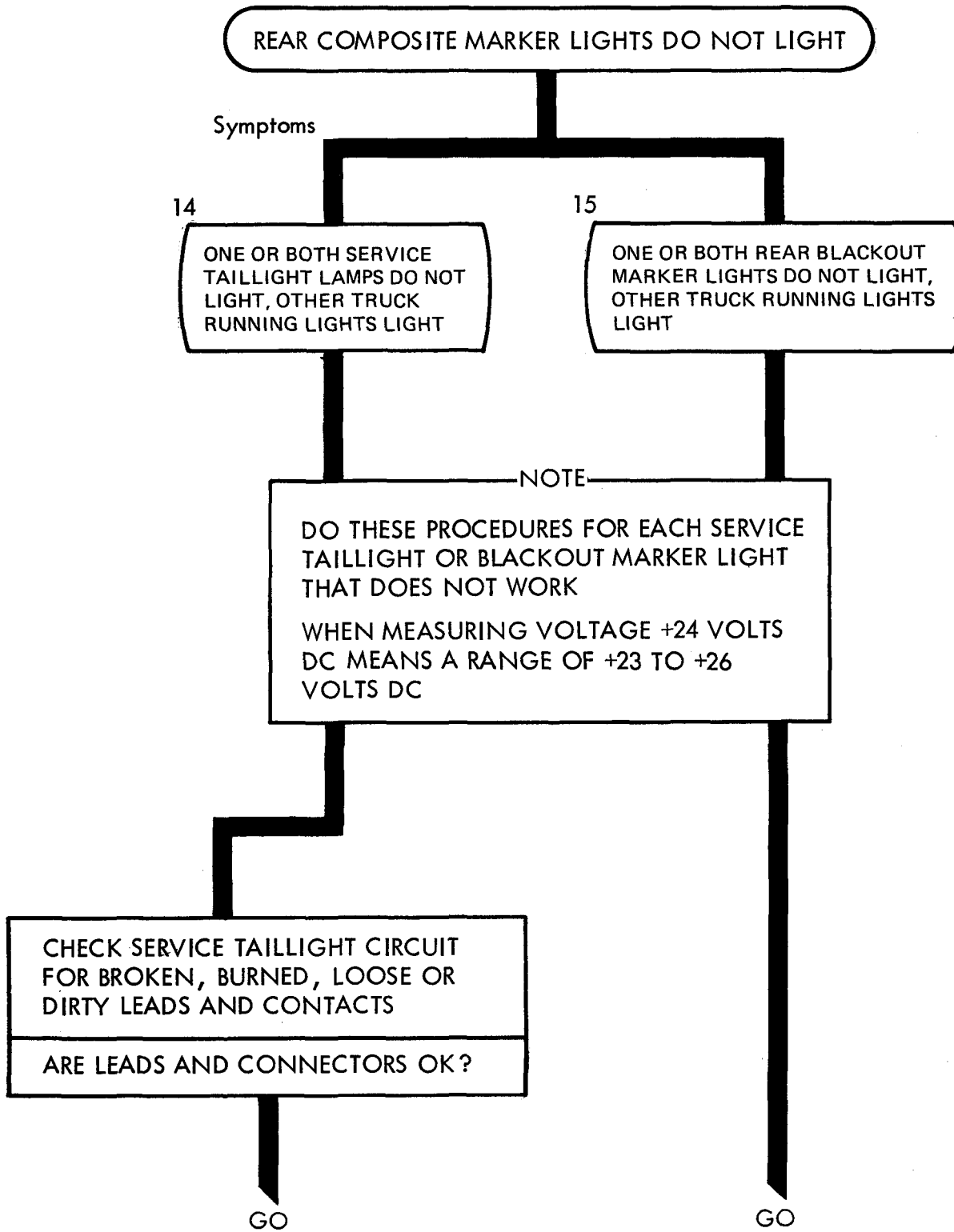

Figure 27-4 (Sheet 10 of 19)

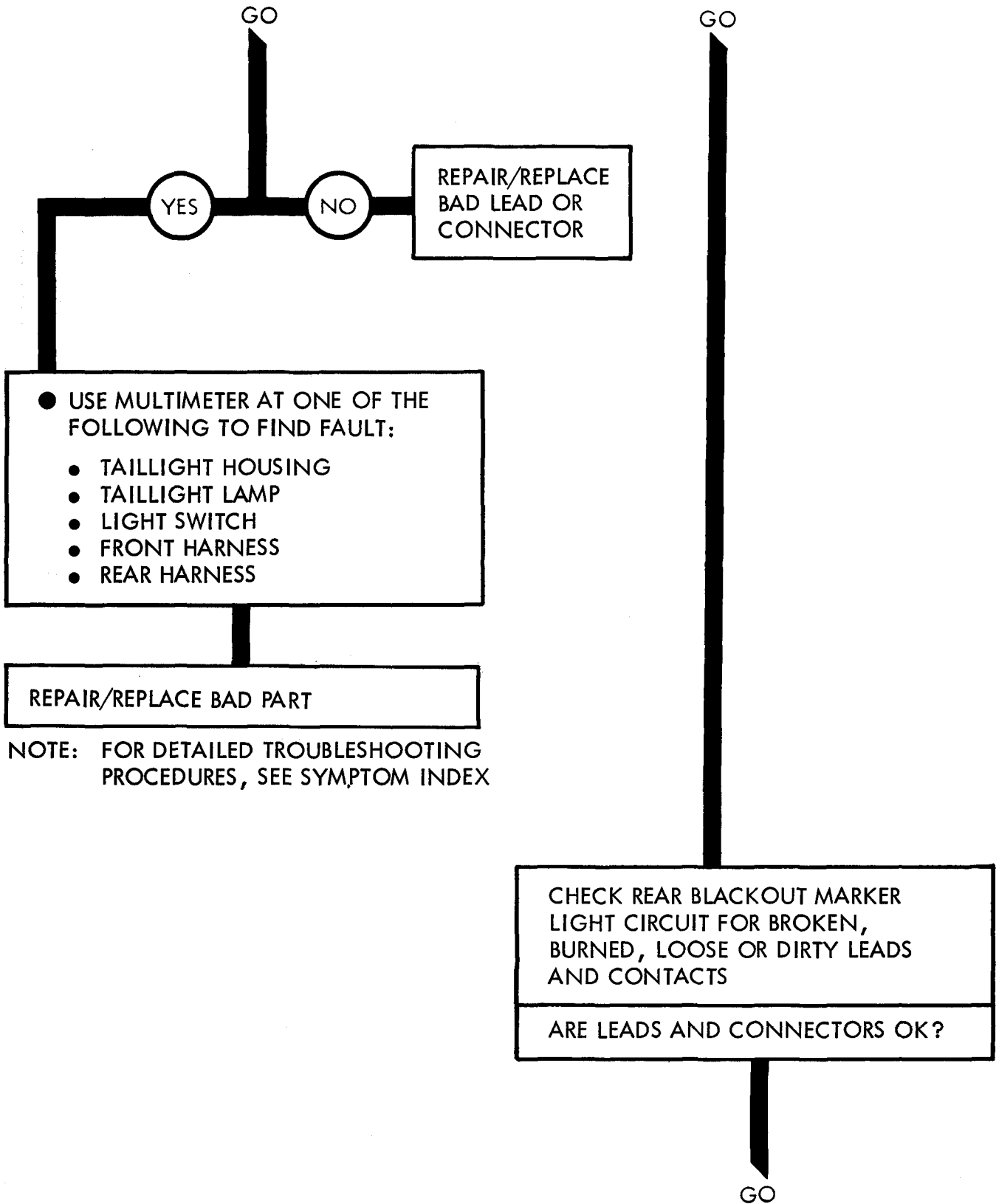
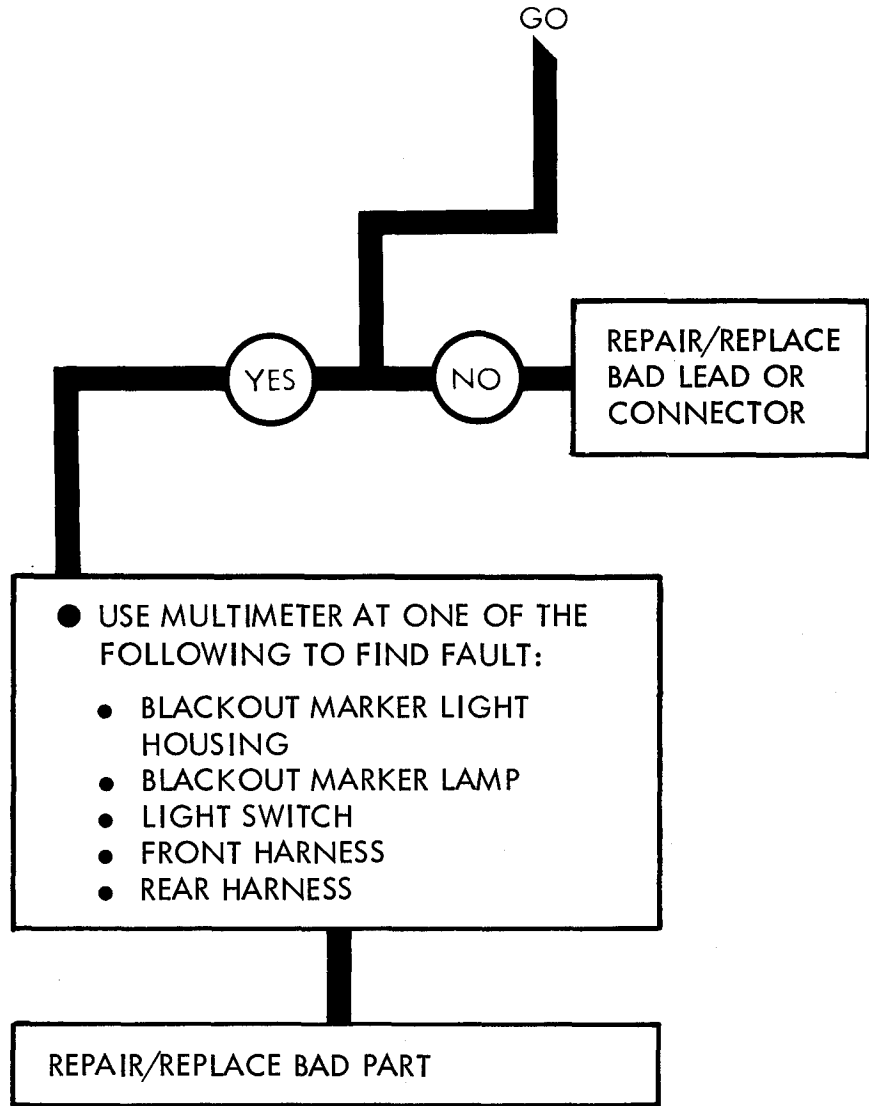
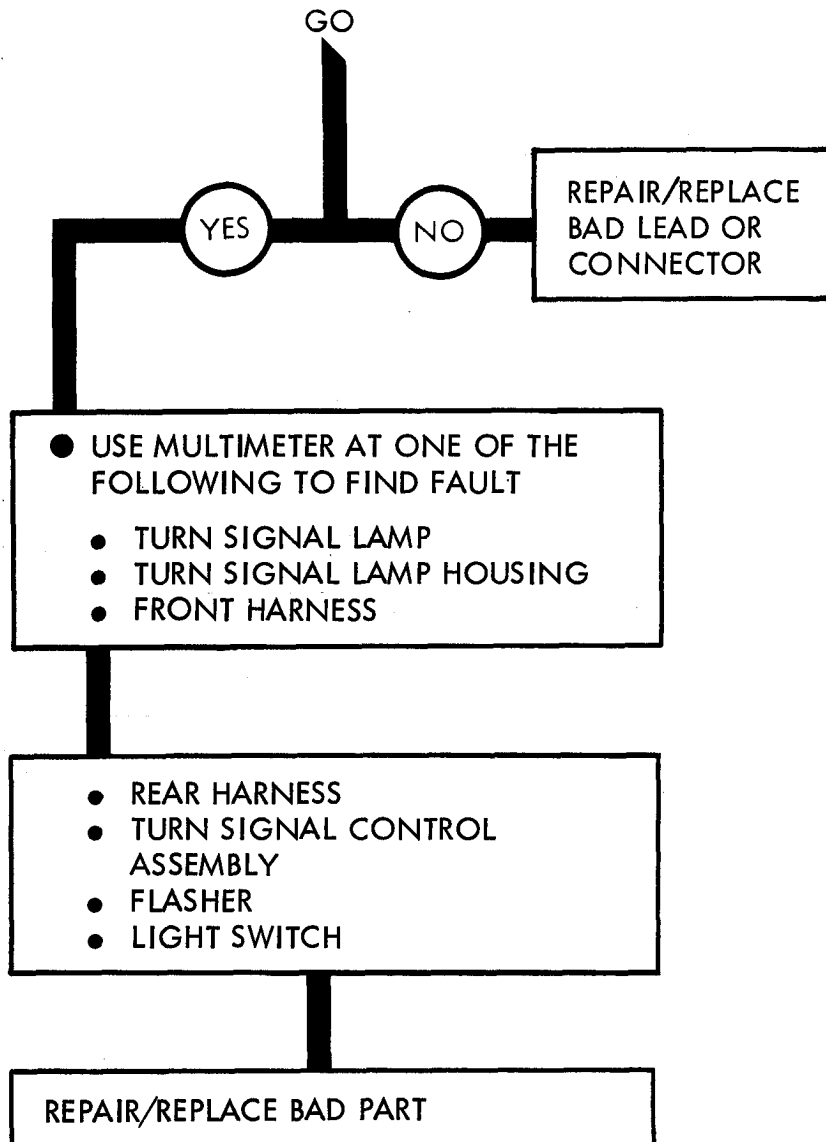

Figure 27-4 (Sheet 11 of 19)



NOTE: FOR DETAILED TROUBLESHOOTING PROCEDURES, SEE SYMPTOM INDEX

Figure 27-4 (Sheet 12 of 19)



NOTE: FOR DETAILED TROUBLESHOOTING PROCEDURES, SEE SYMPTOM INDEX

Figure 27-5 (Sheet 2 of 4)

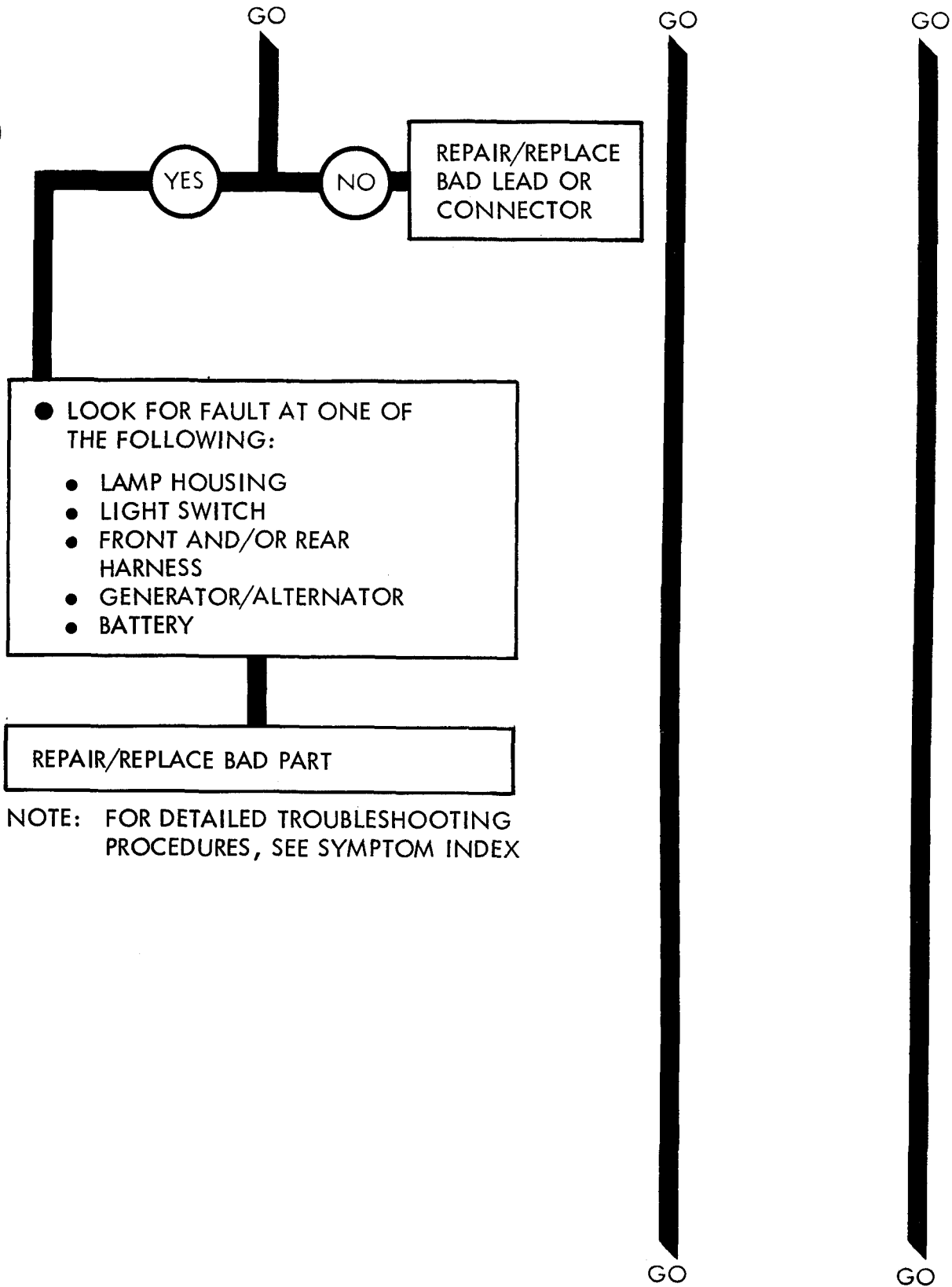

NOTE: FOR DETAILED TROUBLESHOOTING PROCEDURES, SEE SYMPTOM INDEX

Figure 27-4 (Sheet 14 of 19)

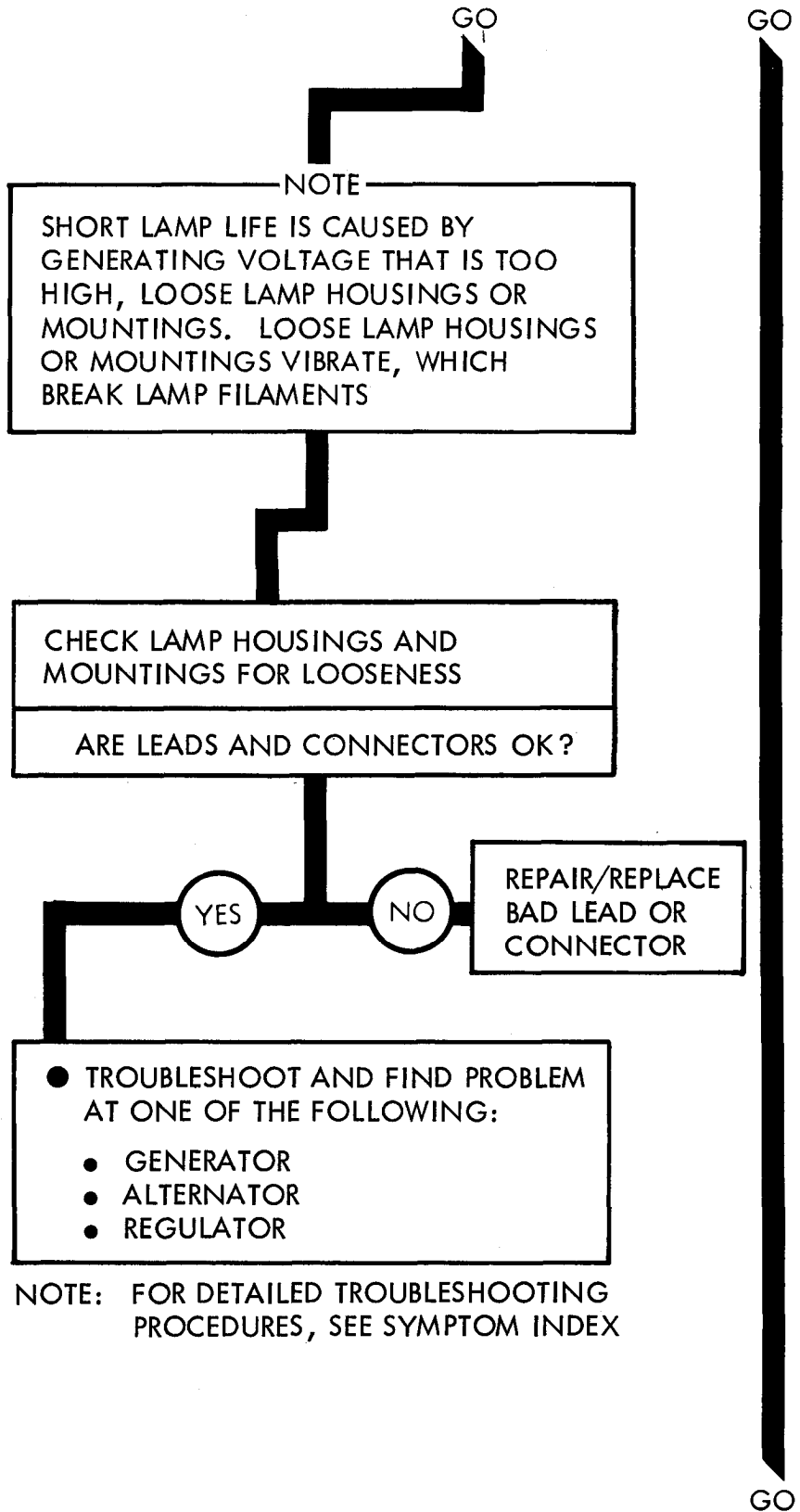

Figure 27-4 (Sheet 15 of 19)

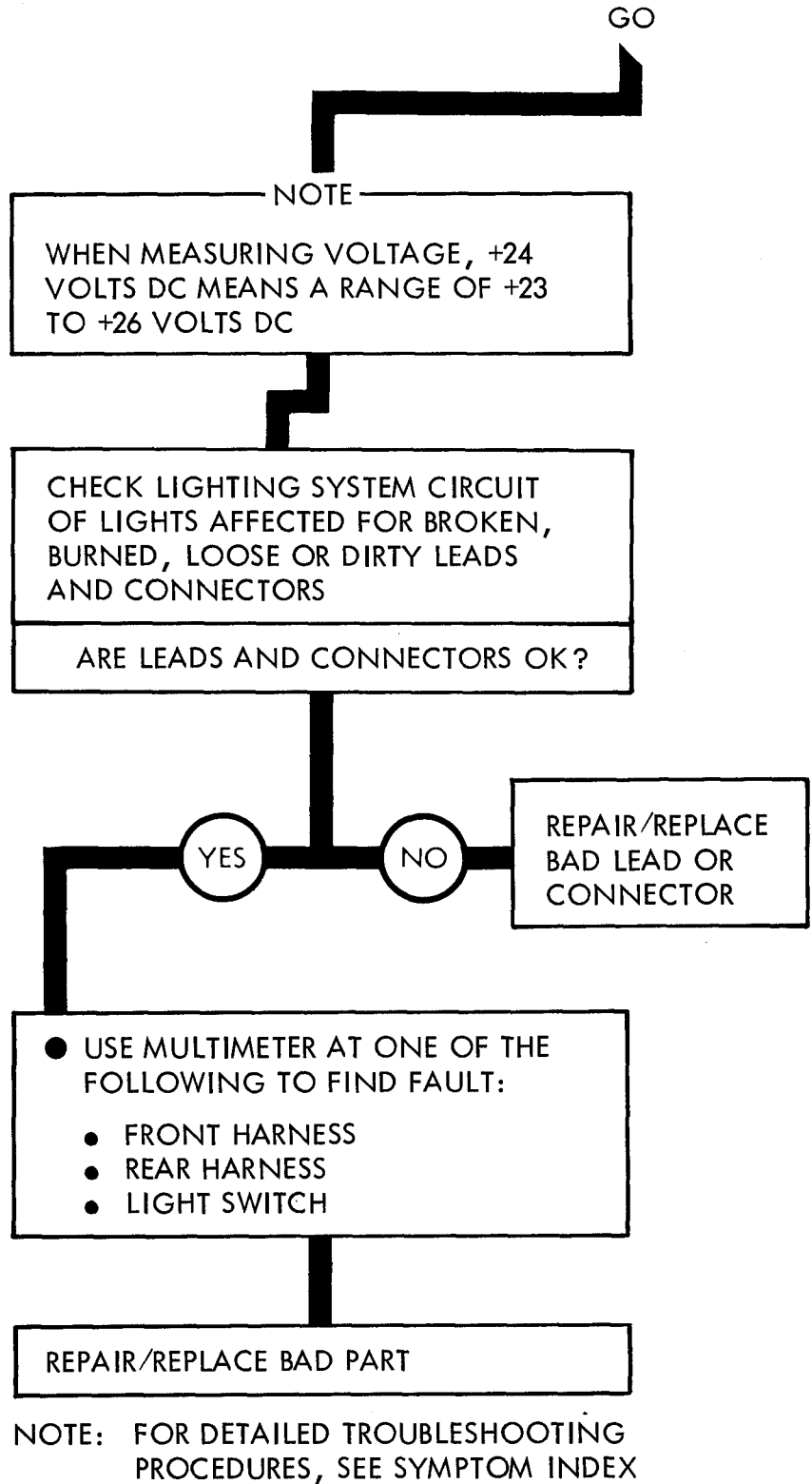

Figure 27-4 (Sheet 16 of 19)

ELECTRICAL SYSTEM - LIGHTING SYSTEM TROUBLESHOOTING SUMMARY

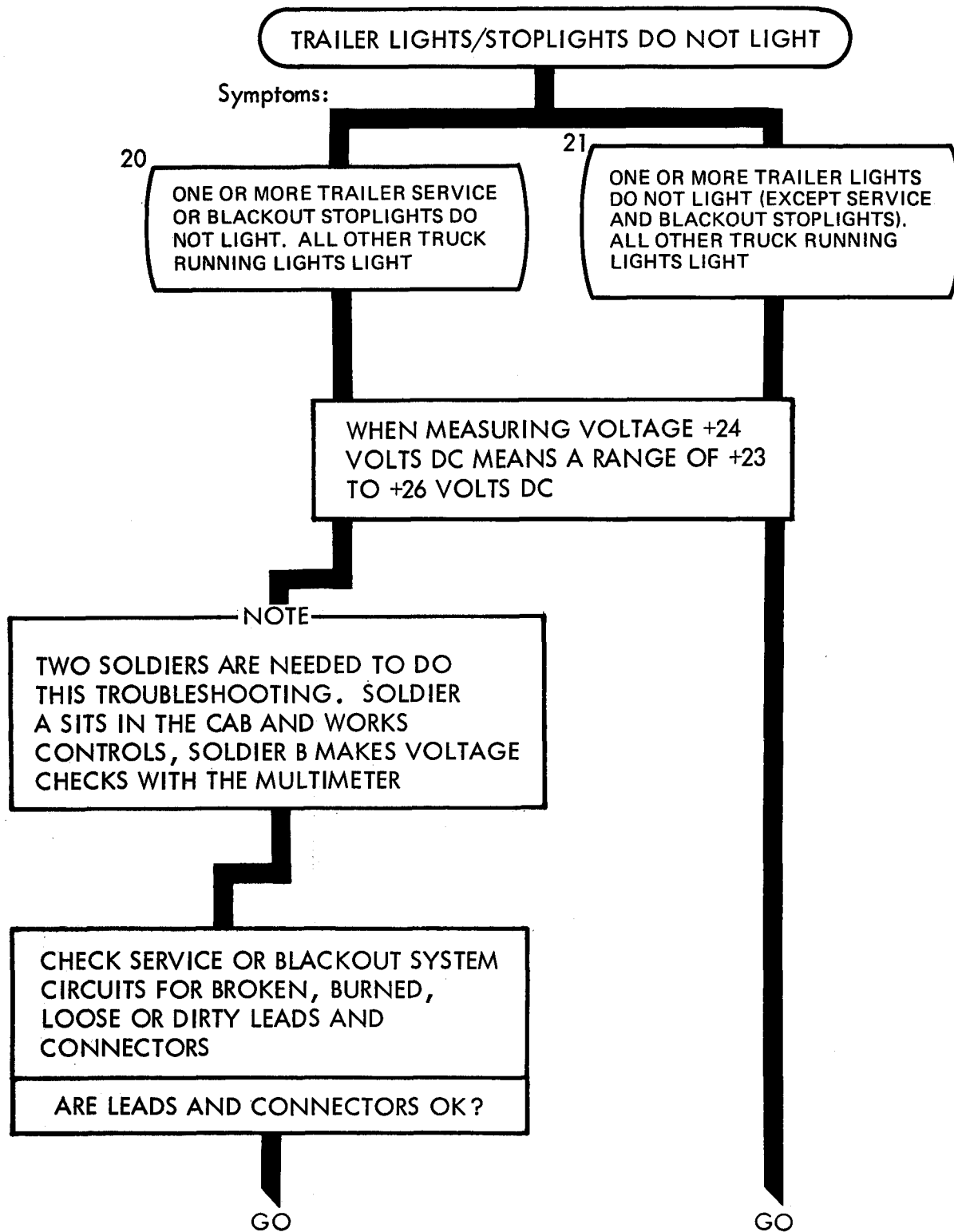

Figure 27-4 (Sheet 17 of 19)

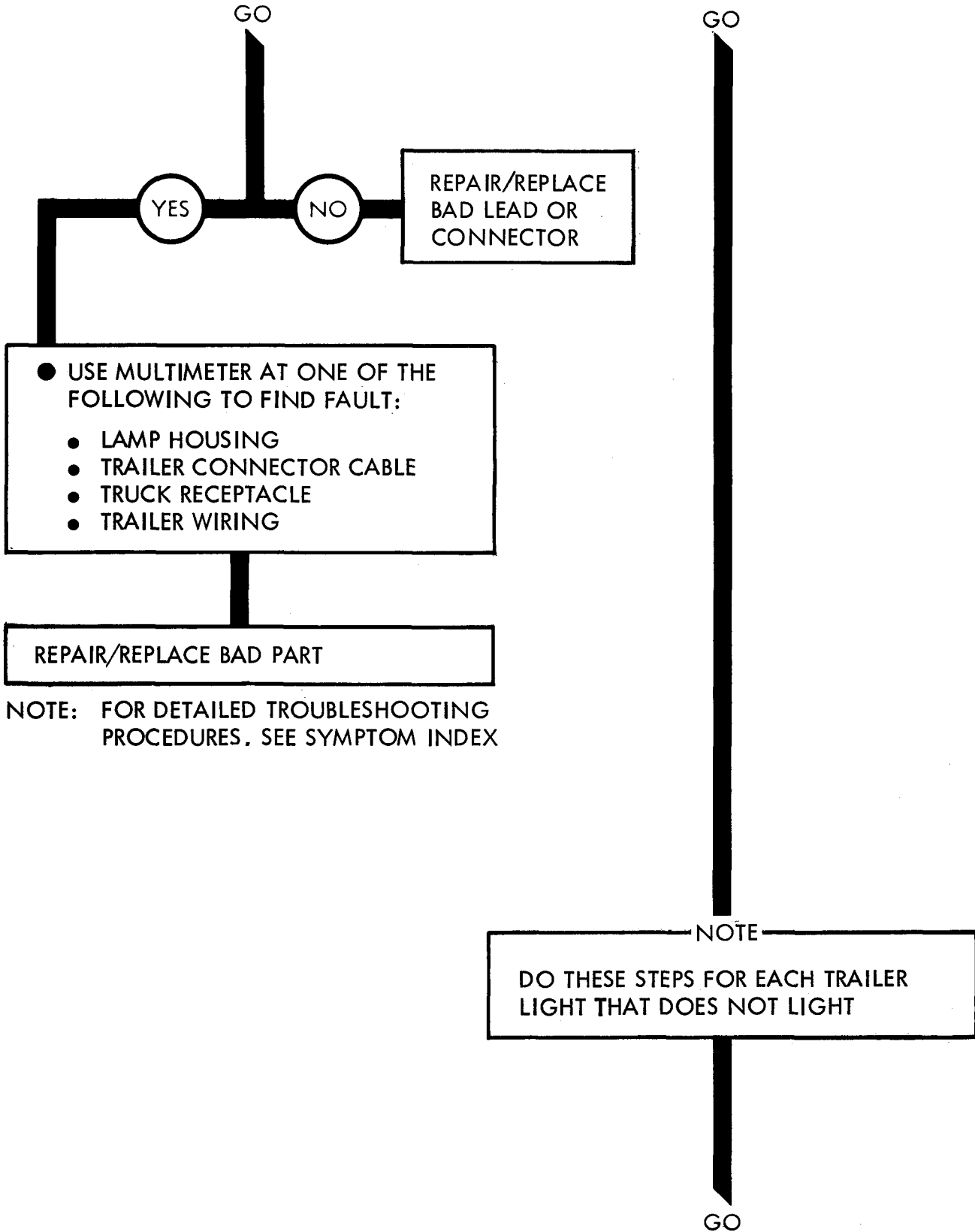

Figure 27-4 (Sheet 18 of 19)

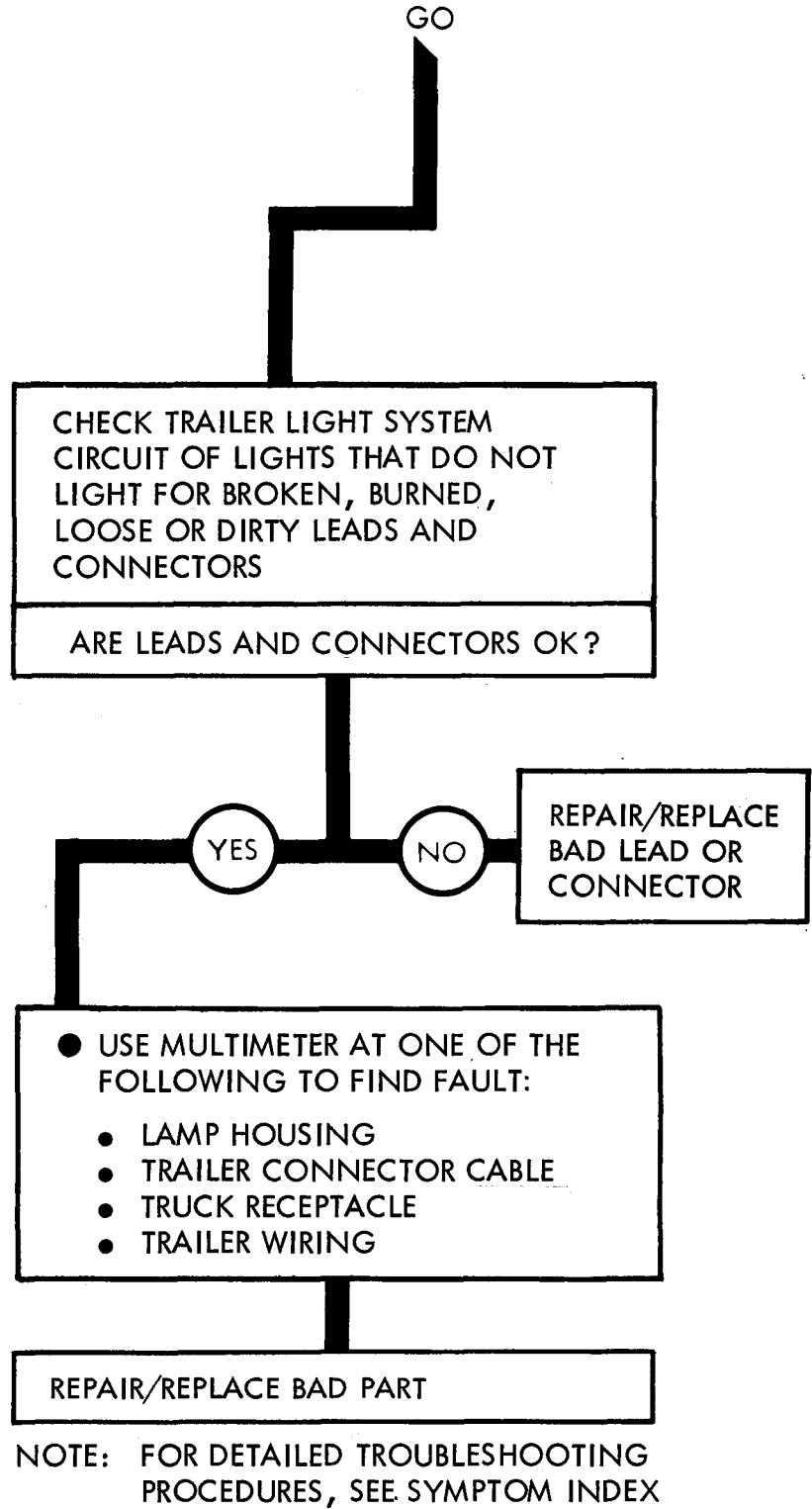

Figure 27-4 (Sheet 19 of 19)

ELECTRICAL SYSTEM - DIRECTIONAL SYSTEM TROUBLESHOOTING SUMMARY

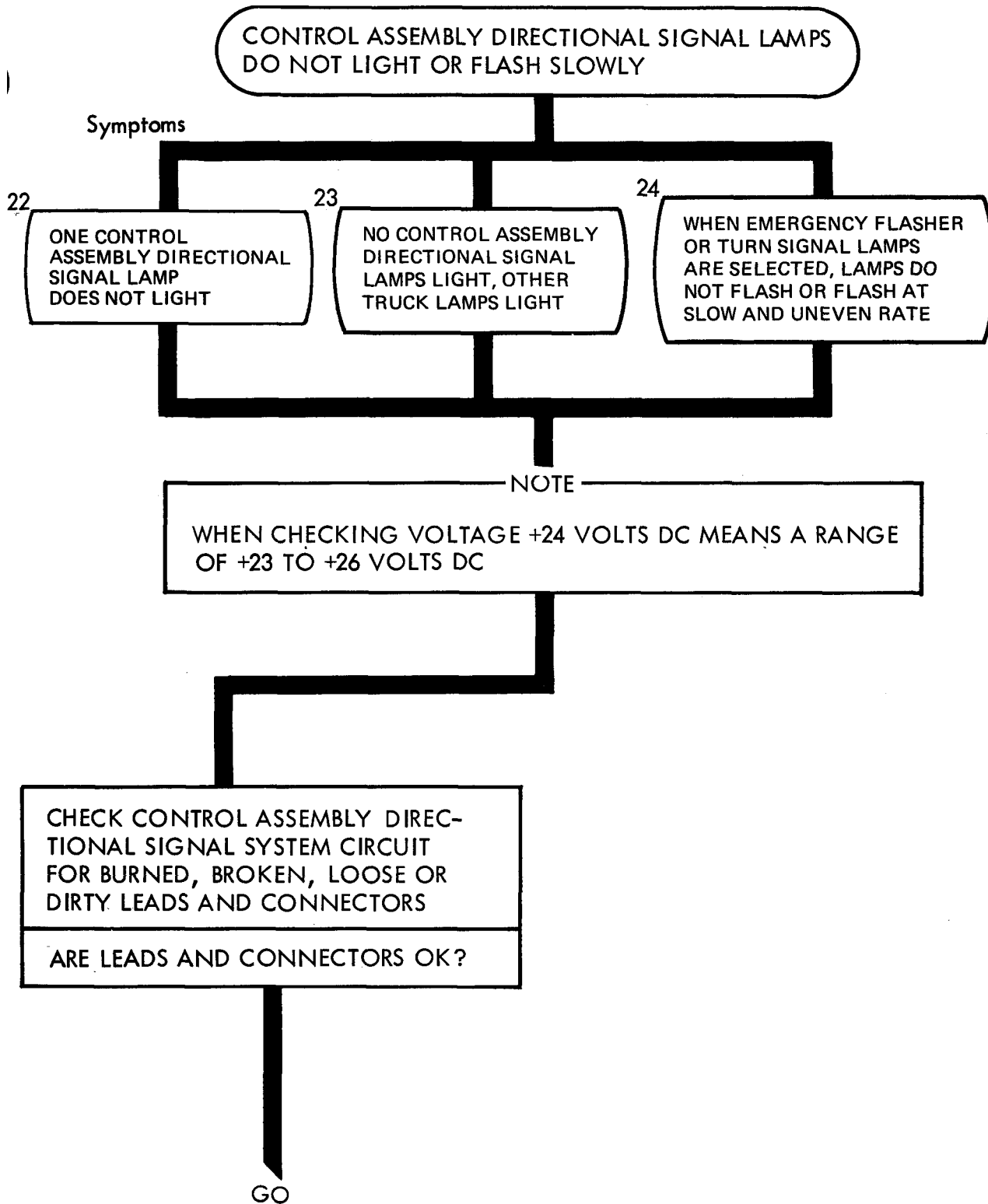
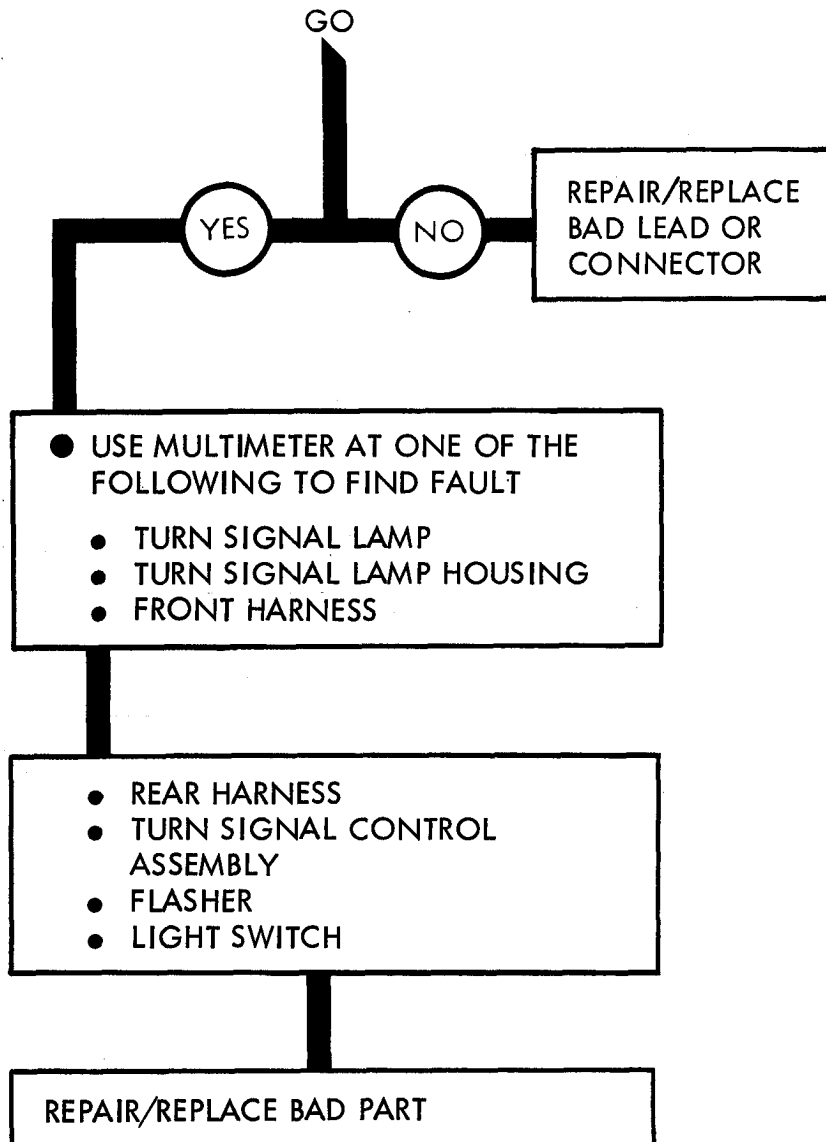

Figure 27-5 (Sheet 1 of 4)



NOTE: FOR DETAILED TROUBLESHOOTING PROCEDURES, SEE SYMPTOM INDEX

Figure 27-5 (Sheet 2 of 4)

ELECTRICAL SYSTEM - INDICATOR SYSTEM TROUBLESHOOTING SUMMARY

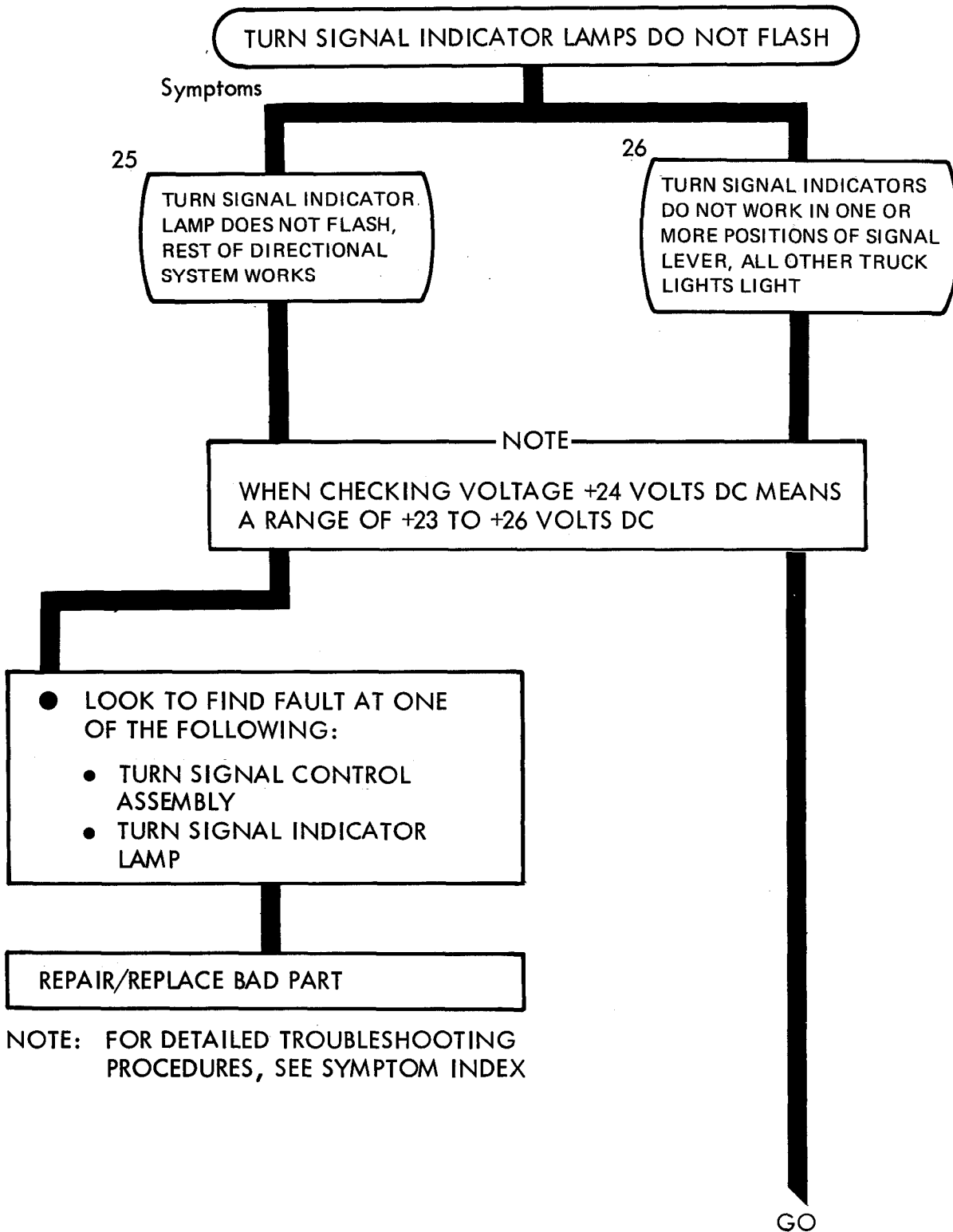
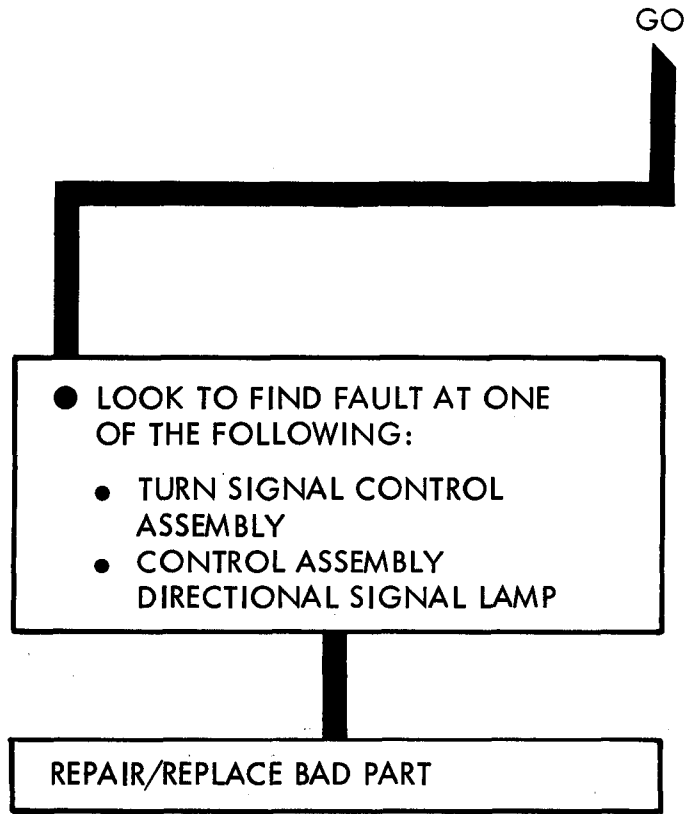

Figure 27-5 (Sheet 3 of 4)



NOTE: FOR DETAILED TROUBLESHOOTING PROCEDURES, SEE SYMPTOM INDEX

Figure 27-5 (Sheet 4 of 4)

ELECTRICAL SYSTEM - INDICATOR SYSTEM TROUBLESHOOTING SUMMARY

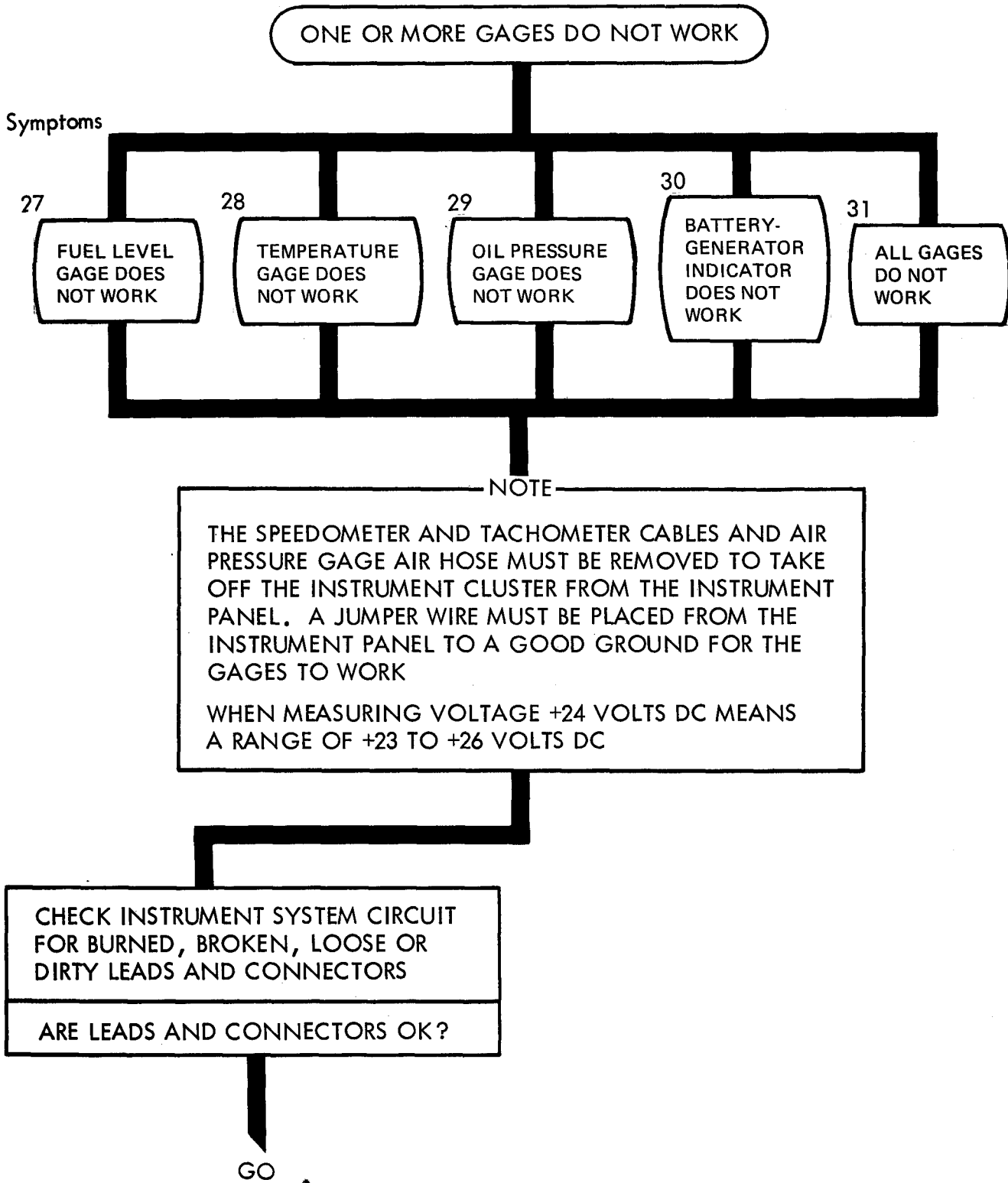

Figure 27-6 (Sheet 1 of 2)

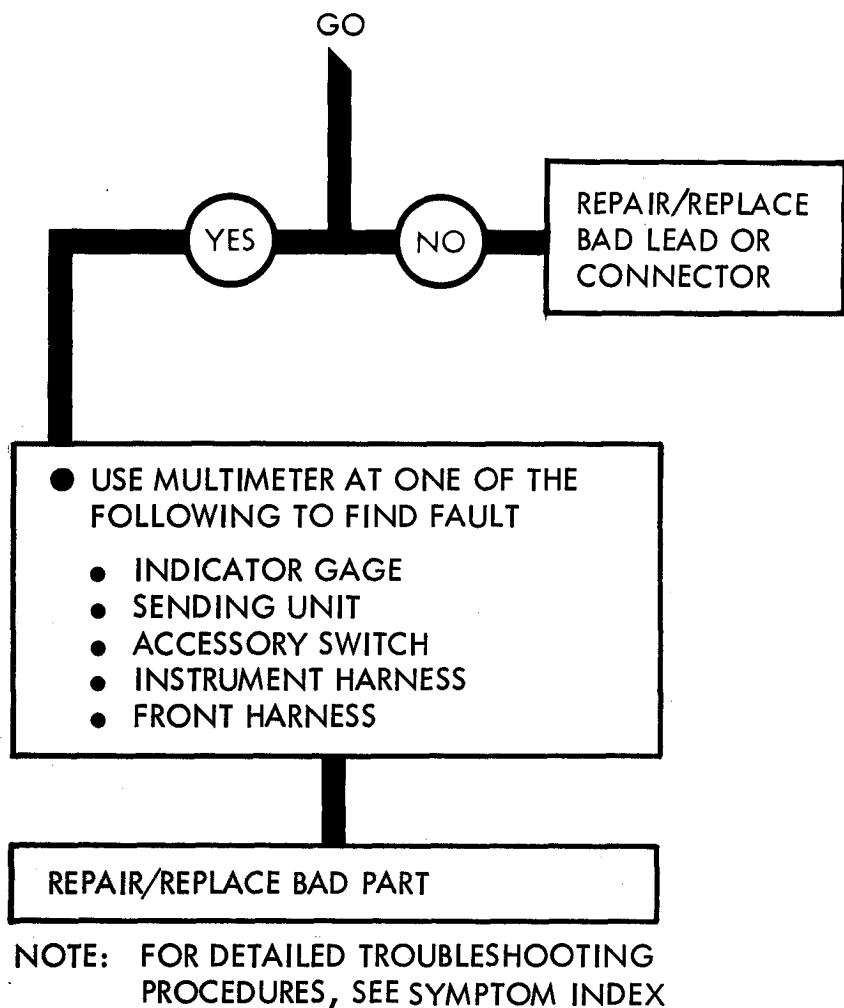

Figure 27-6 (Sheet 2 of 2)

ELECTRICAL SYSTEM - WARNING SYSTEM TROUBLESHOOTING SUMMARY

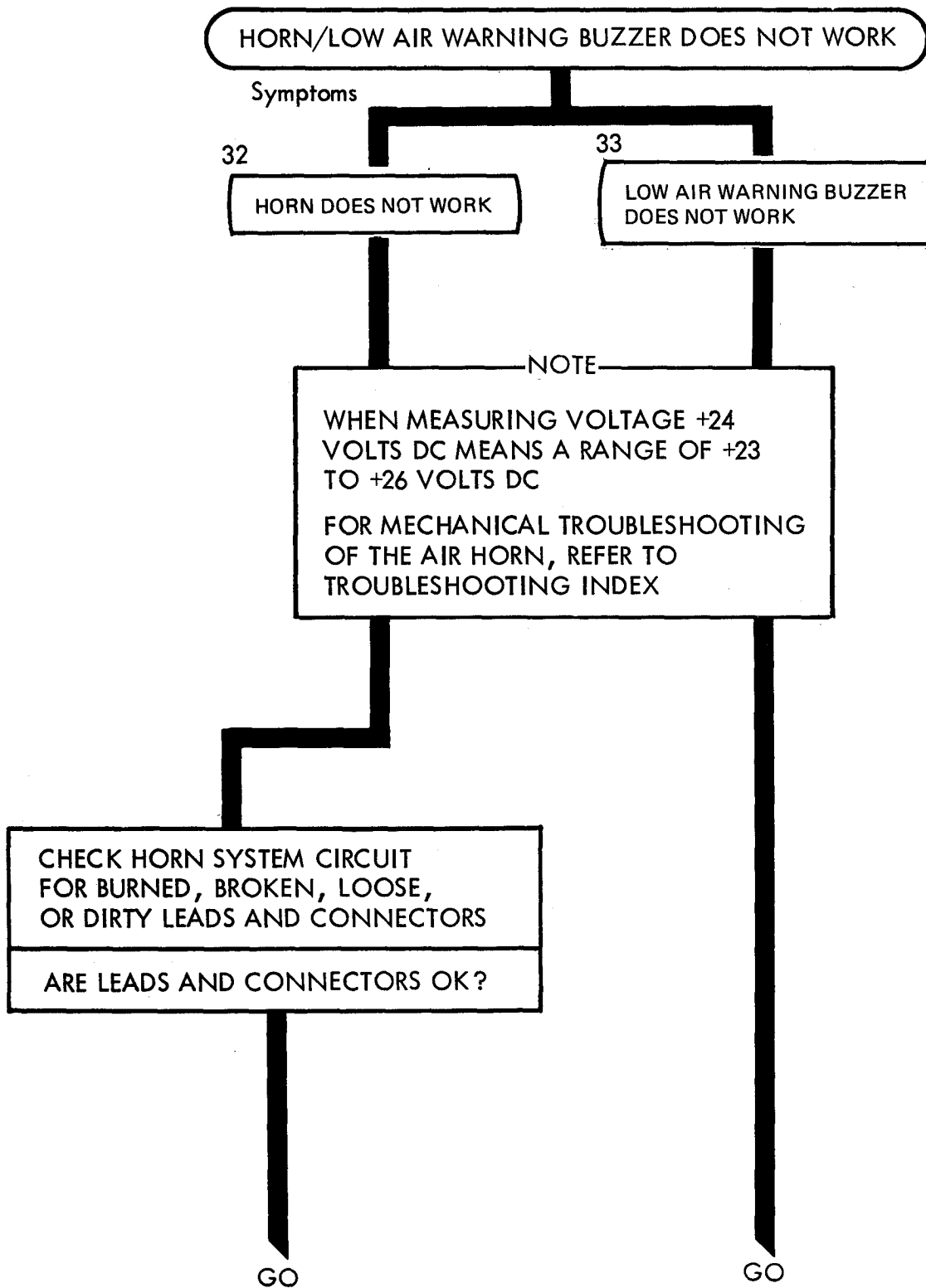

Figure 27-7 (Sheet 1 of 3)

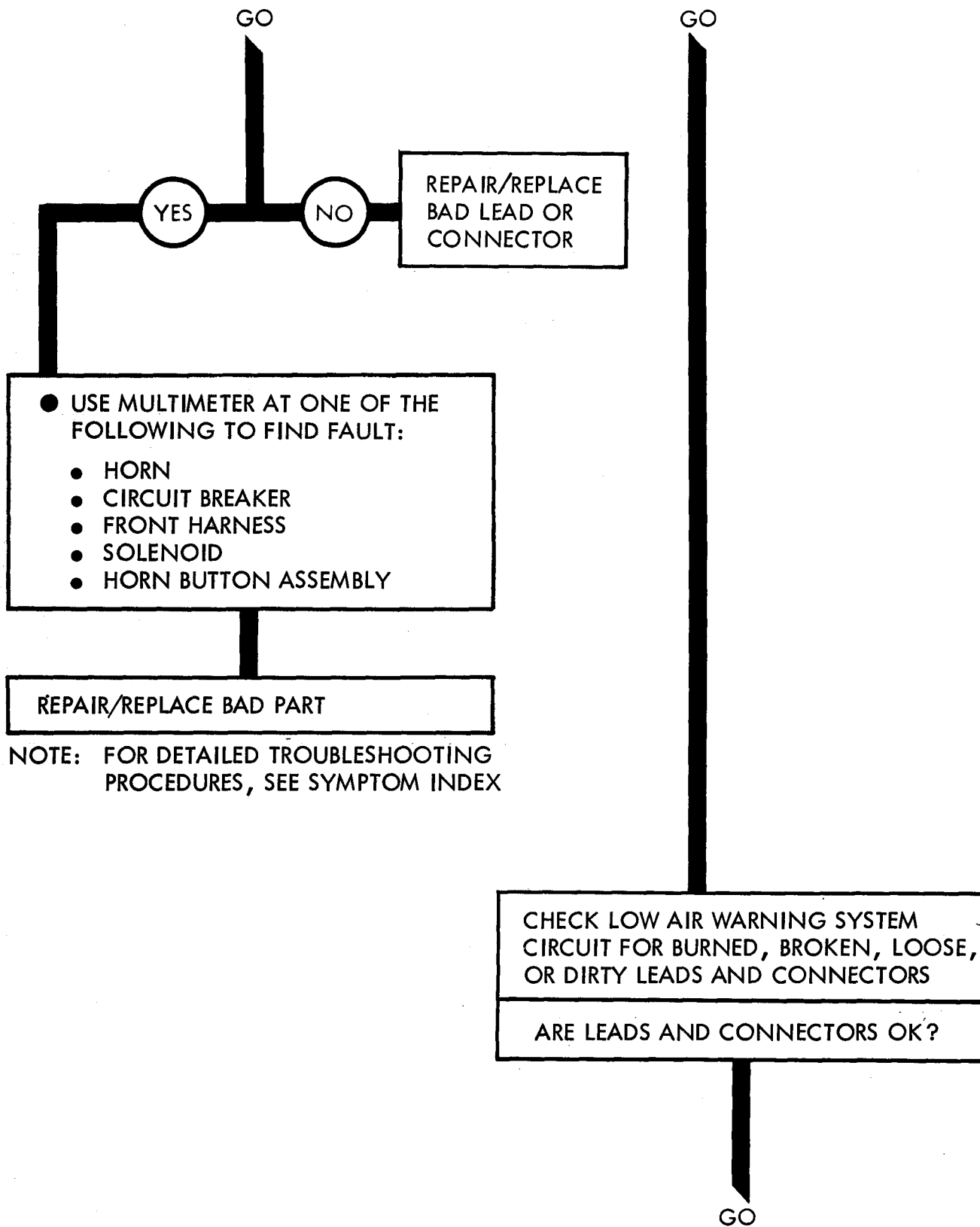
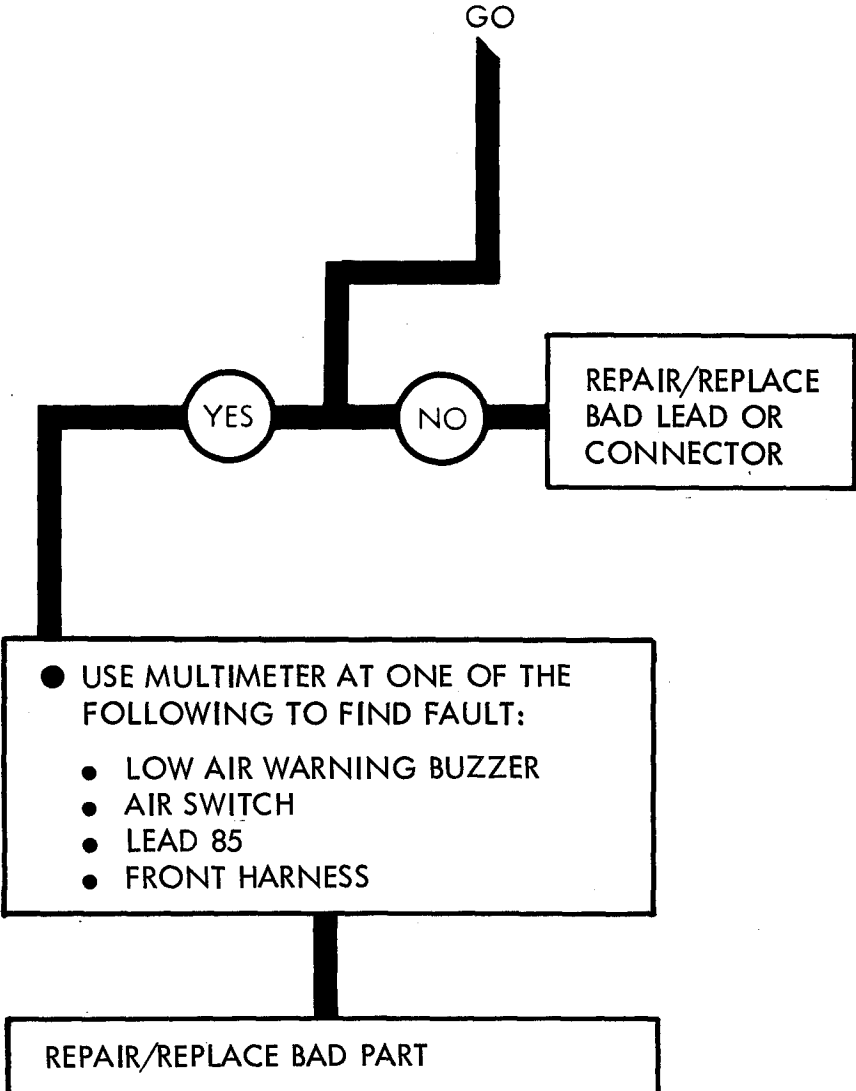

Figure 27-7 (Sheet 2 of 3)



NOTE: FOR DETAILED TROUBLESHOOTING PROCEDURES, SEE SYMPTOM INDEX

Figure 27-7 (Sheet 3 of 3)

ELECTRICAL SYSTEM - FUEL PUMP/ENGINE MANIFOLD HEATER TROUBLESHOOTING SUMMARY

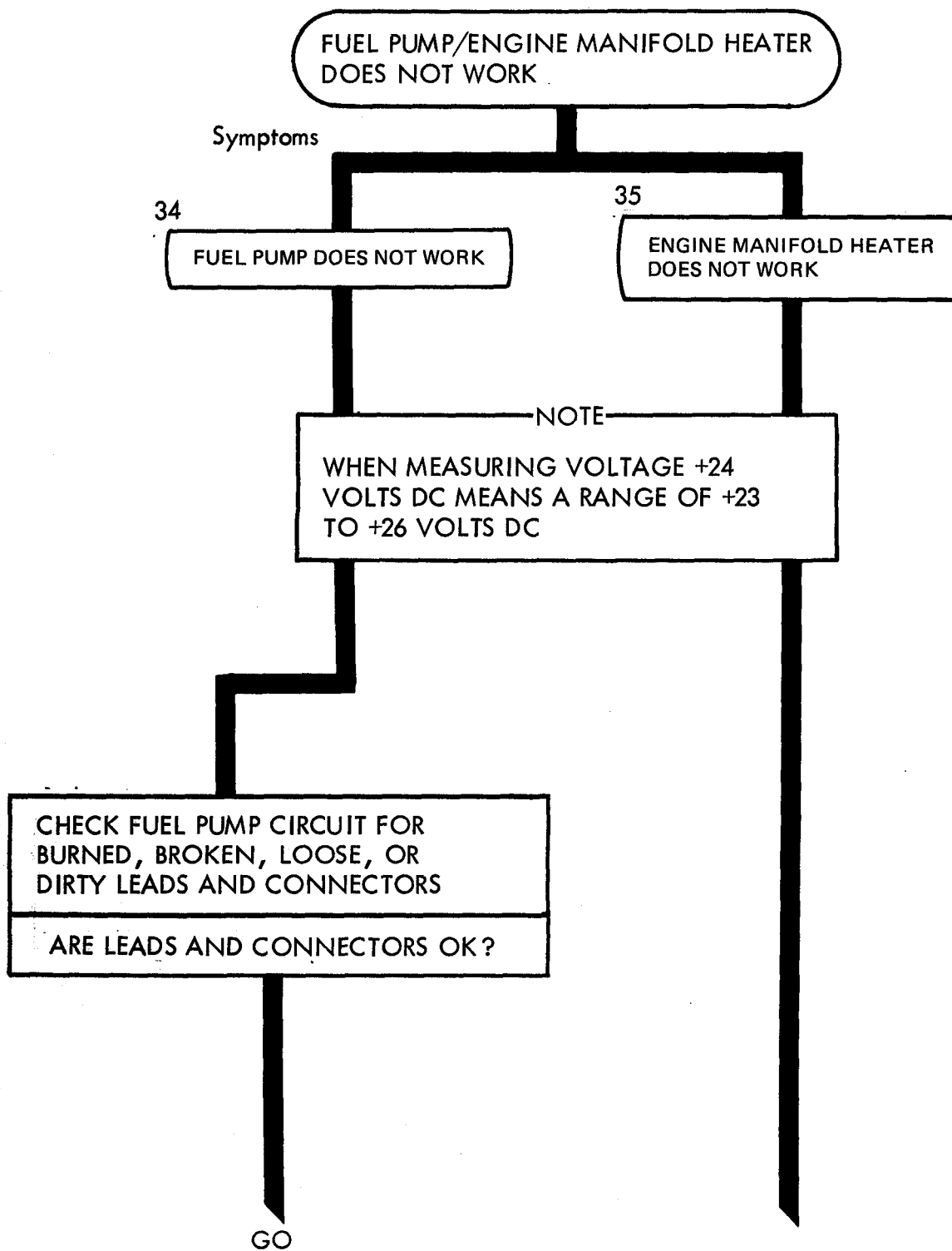
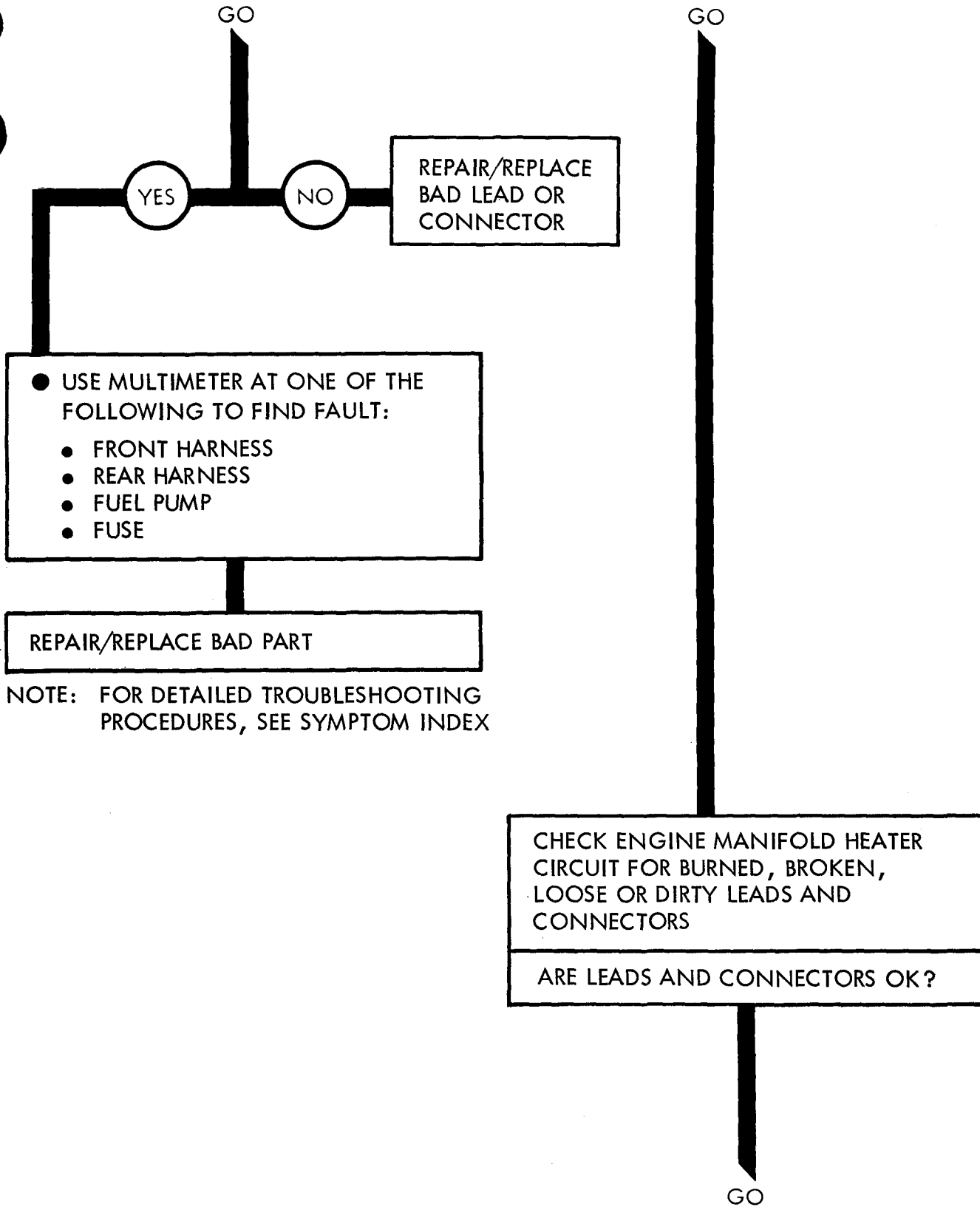

Figure 27-8 (Sheet 1 of 3)



NOTE: FOR DETAILED TROUBLESHOOTING PROCEDURES, SEE SYMPTOM INDEX

Figure 27-8 (Sheet 2 of 3)

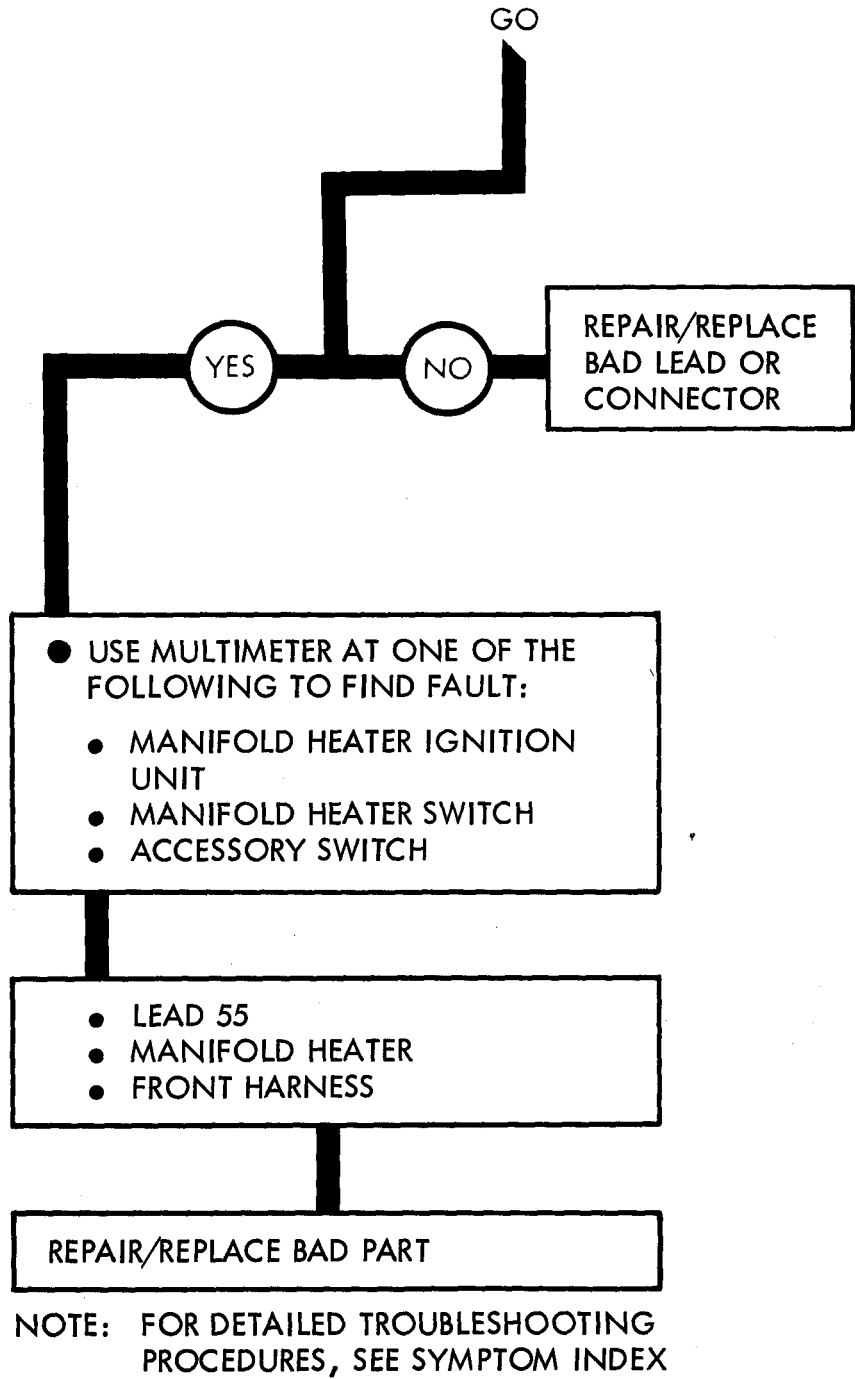

Figure 27-8 (Sheet 3 of 3)

ELECTRICAL SYSTEM - HOT WATER PERSONNEL HEATER DEFROSTER
TROUBLESHOOTING SUMMARY

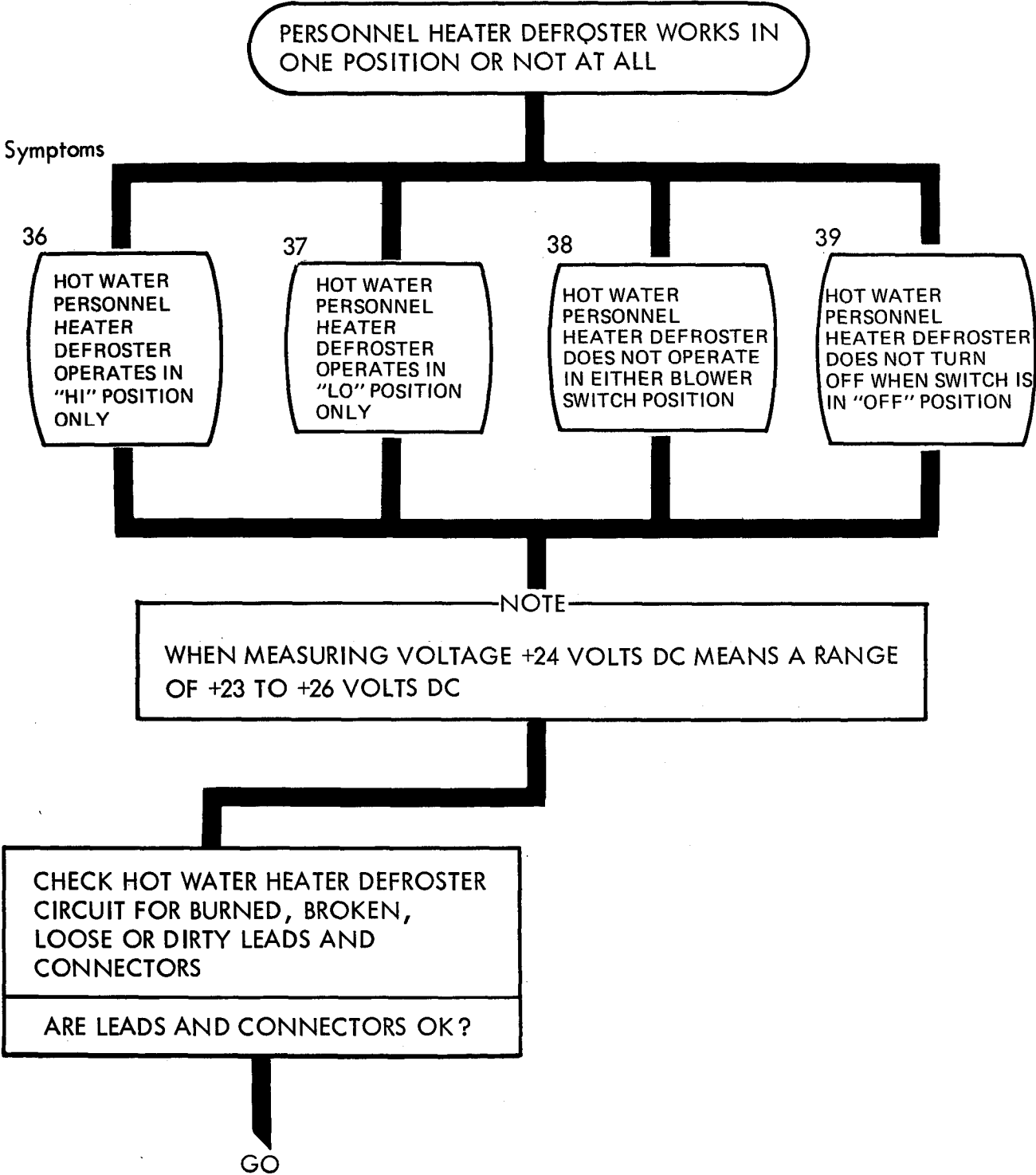
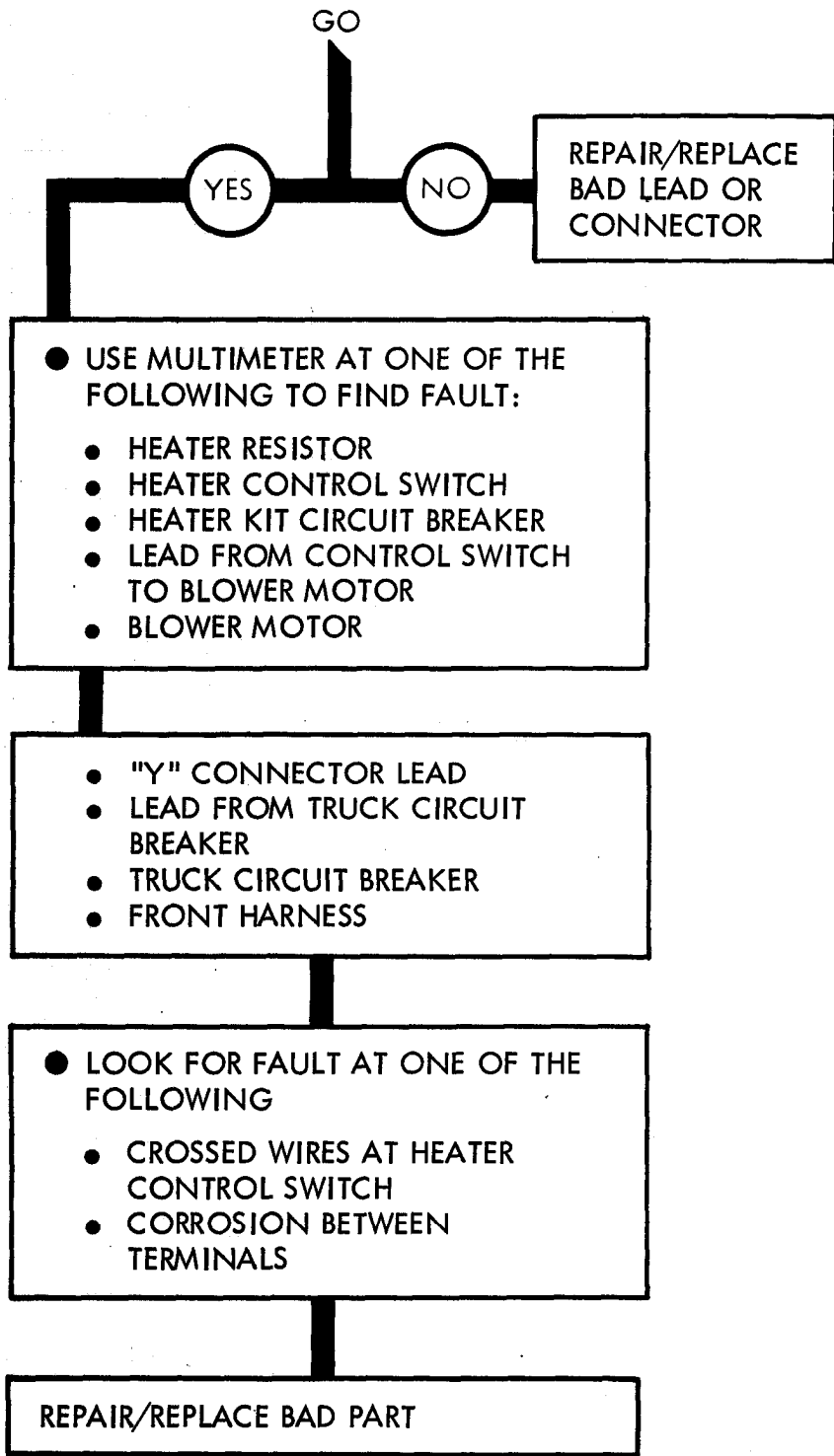

Figure 27-9 (Sheet 1 of 2)



NOTE: FOR DETAILED TROUBLESHOOTING PROCEDURES, SEE SYMPTOM INDEX

Figure 27-9 (Sheet 2 of 2)

ELECTRICAL SYSTEM - WINTERIZATION KIT TROUBLESHOOTING SUMMARY

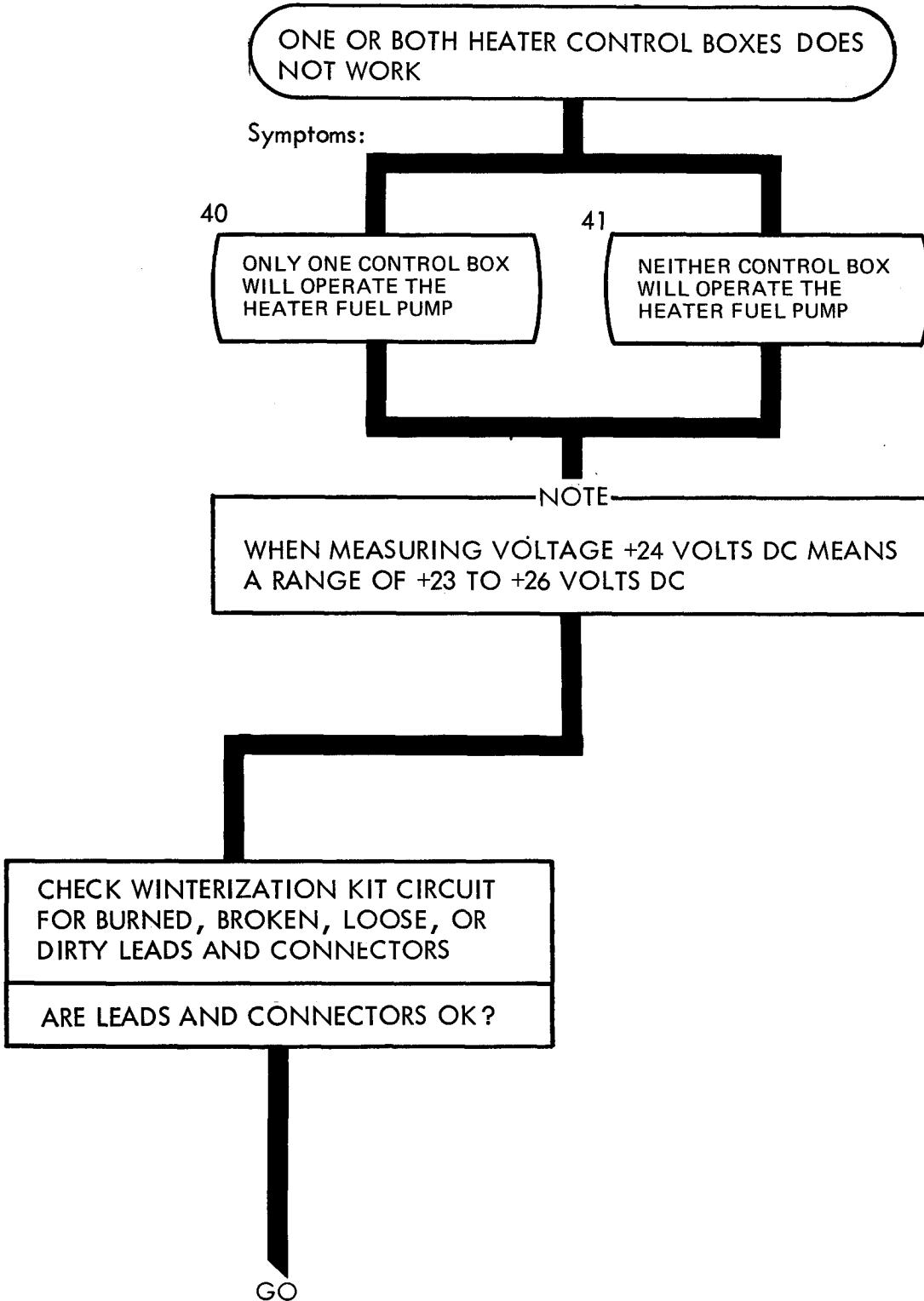
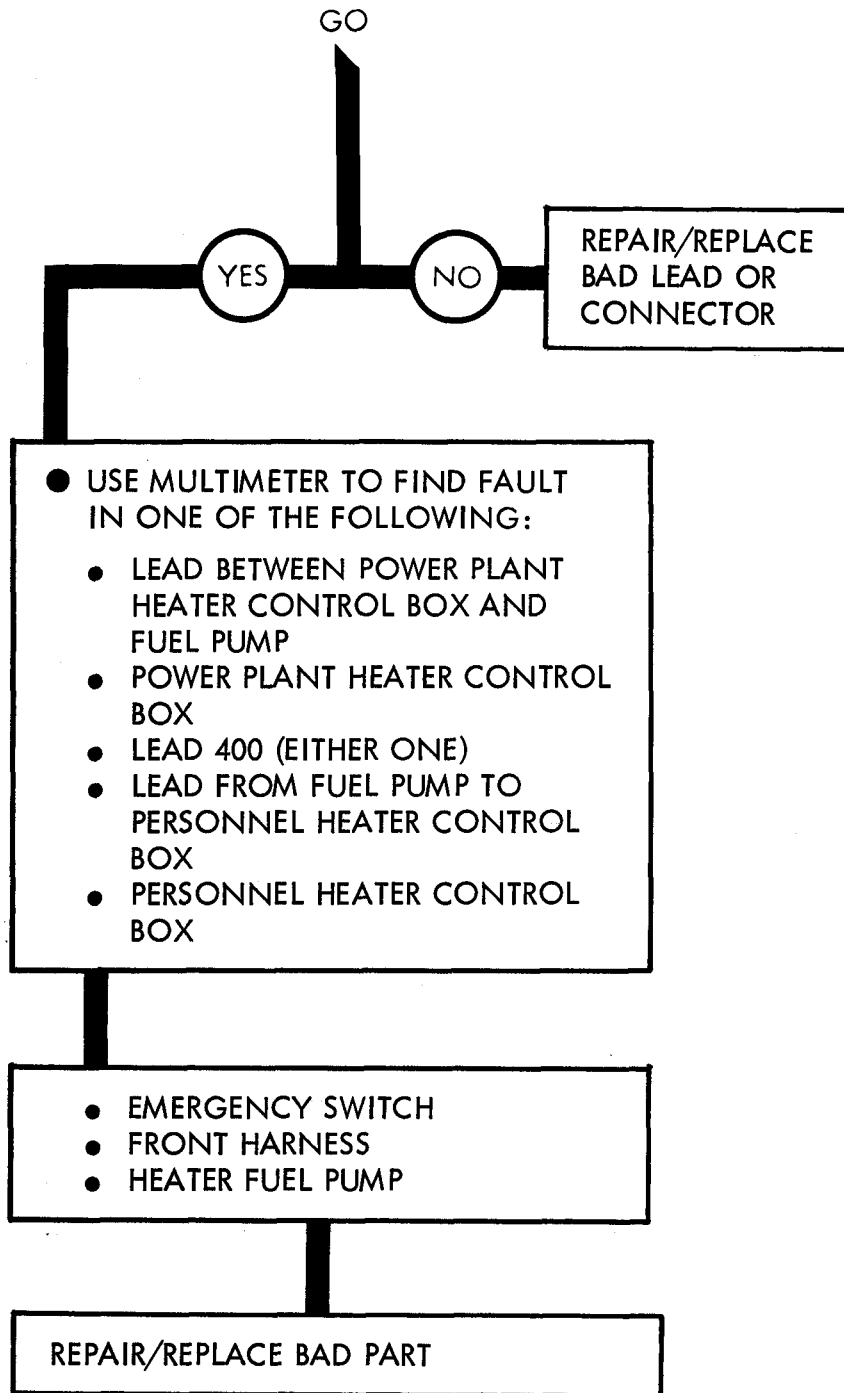

Figure 27-10 (Sheet 1 of 2)



NOTE: FOR DETAILED TROUBLESHOOTING PROCEDURES, SEE TROUBLESHOOTING

Figure 27-10 (Sheet 2 of 2)

CHAPTER 28

ELECTRICAL SYSTEM SUPPORT DIAGRAMS

28-1. GENERAL. This chapter gives the diagrams you need when doing troubleshooting procedures in chapter 26. Table 3-1 is a complete listing of all support diagrams used in this manual.

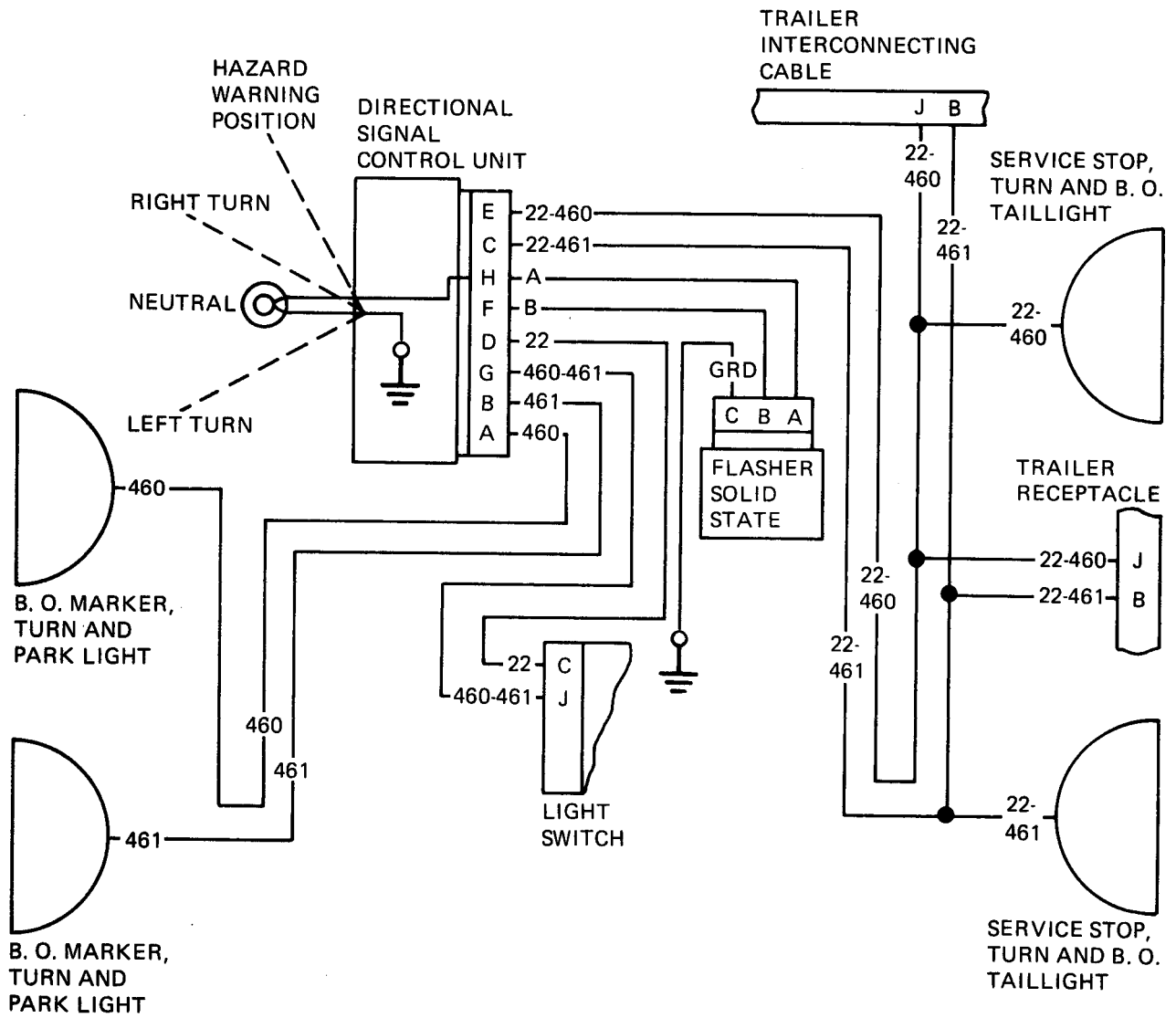

TA 116062

Figure 28-1. Wiring Diagram for Directional Signal Circuit

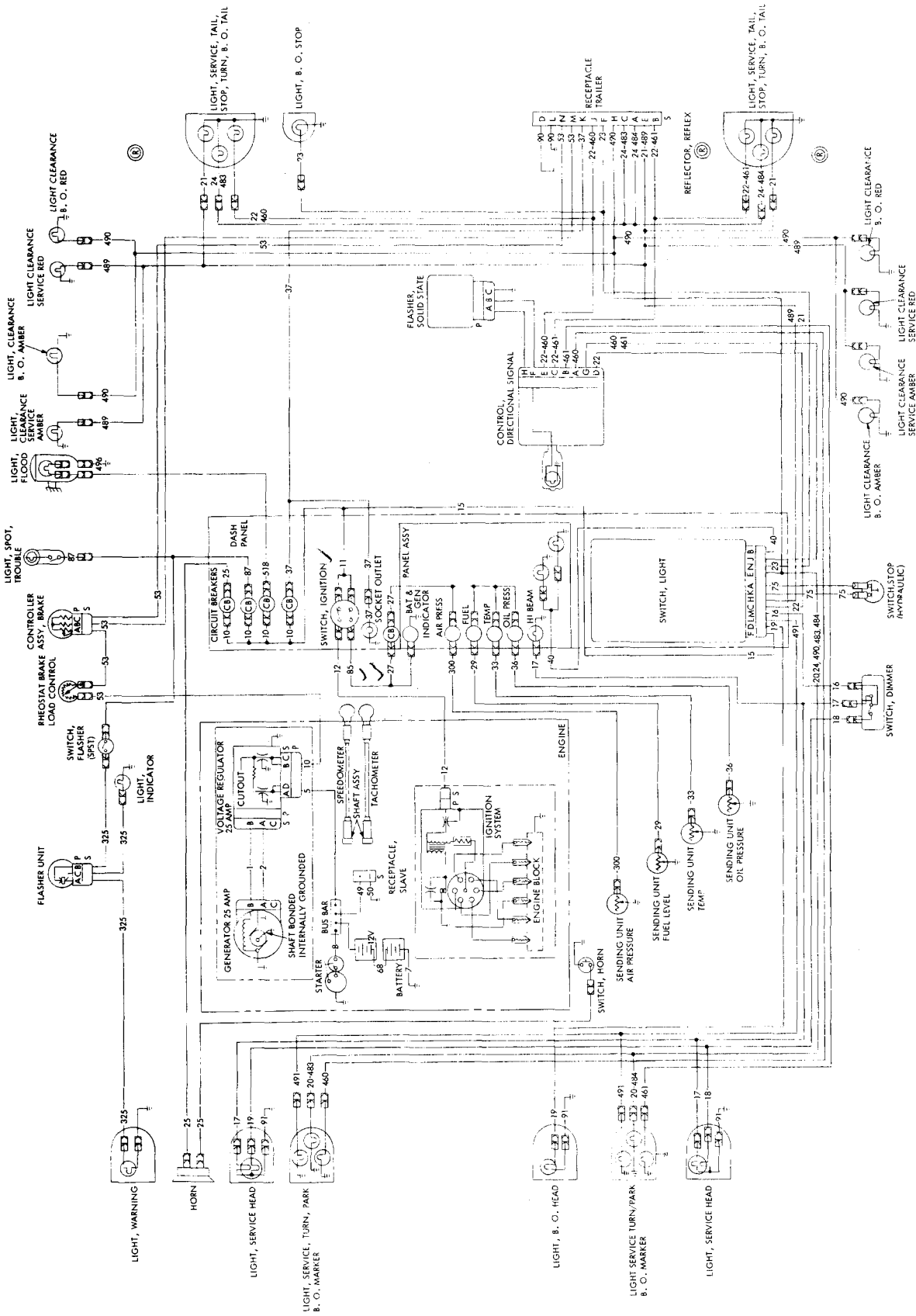

TA 116063

Figure 28-2. Truck Wiring Diagram

CHAPTER 29

ELECTRICAL SYSTEM TEST PROCEDURES

29-1. GENERAL . This chapter gives test procedures for the multimeter troubleshooting.

29-2. TEST SET-UP. Instructions for setup of test equipment and parts to be tested are given before the test procedures. Illustrations are used, when needed, to show you how to hook up the test equipment to the part to be tested.

29-3. TEST PROCEDURE . Detailed step-by- step instructions, in flow chart form are given for each test. The procedure calls out the type of test and the conditions of the truck system for each part of testing. The step-by- step test will lead you to the bad component or to a fault symptom within a related system. Reference is made to the fault symptom index, chapter 28 if the test shows a fault in another system.

MULTIMETER AN/URM-105C TEST PROCEDURES

GENERAL INSTRUCTIONS

- Check That Multimeter is Ready for Use
 - Calibration label - Check to be sure multimeter has been calibrated in the last 12 months
 - Meter - Glass and pointer not broken. Pointer should be resting over zero mark at left side of scales
 - Batteries - Not corroded or leaking Put in right.

- Cables - No cuts, sharp kinks or bad fraying
- Test prods - Tight on cable, tip free of paint or anything that might be an insulator
- Switch and knob - Work freely without binding or scraping
- Alligator clips - Free of paint or anything that might be an insulator

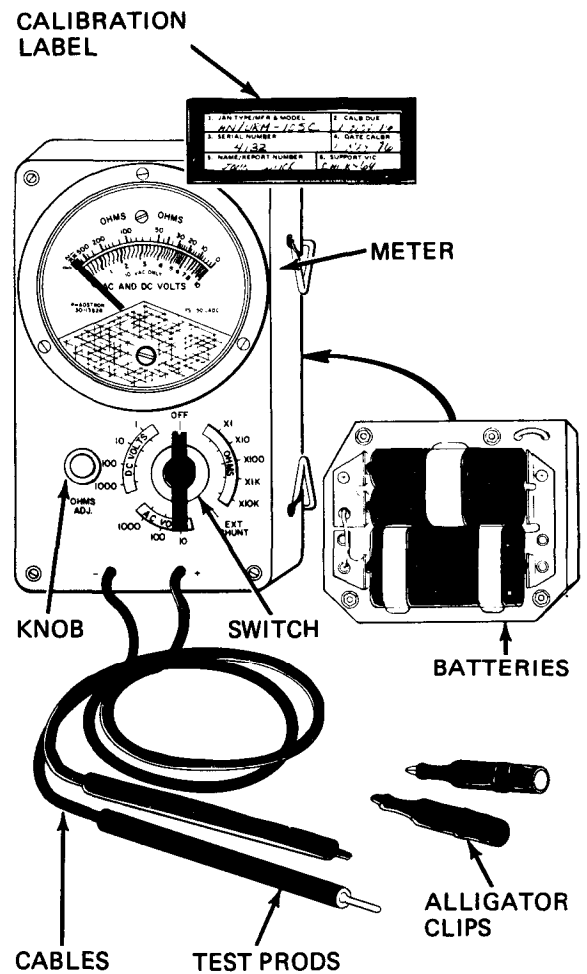

Figure 29-1

Test

1

DC VOLTAGE TEST - To measure battery voltage, charging system output, and voltage drops at various test points

1

- Set up selector switch
 Note: The highest truck DC voltage that is measured is about 28 volts. Therefore, the selector switch is never set to 1000 DC VOLTS
- See table to find out setting of selector switch. Table shows switch setting when normal value of measured voltage is known or unknown

IF NORMAL VALUE OF VOLTAGE BEING MEASURED IS THIS:	SET SELECTOR SWITCH TO:
0 TO 0.8 VOLTS	1 DC VOLTS
0.8 TO 8 VOLTS	10 DC VOLTS
8 TO 80 VOLTS	100 DC VOLTS
UNKNOWN	100 DC VOLTS

- Set selector switch to setting you picked
 Note: The OHMS ADJ knob is not used for DC voltage tests

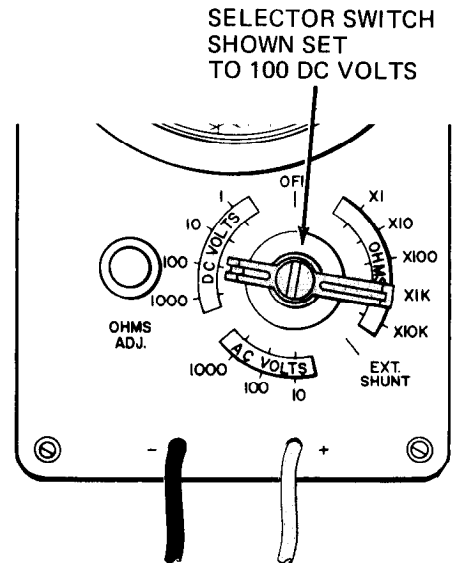

NOTE
 When you need to turn on power before measuring DC voltage, the fault isolation procedures gives the turn-on instructions

GO

Figure 29-2 (Sheet 1 of 5)

GO

2

- Put multimeter leads across (in parallel with) circuit being measured
- Put test prod of black lead (-) on negative terminal of circuit being measured
- Put test prod of red lead (+) on positive terminal of circuit being measured

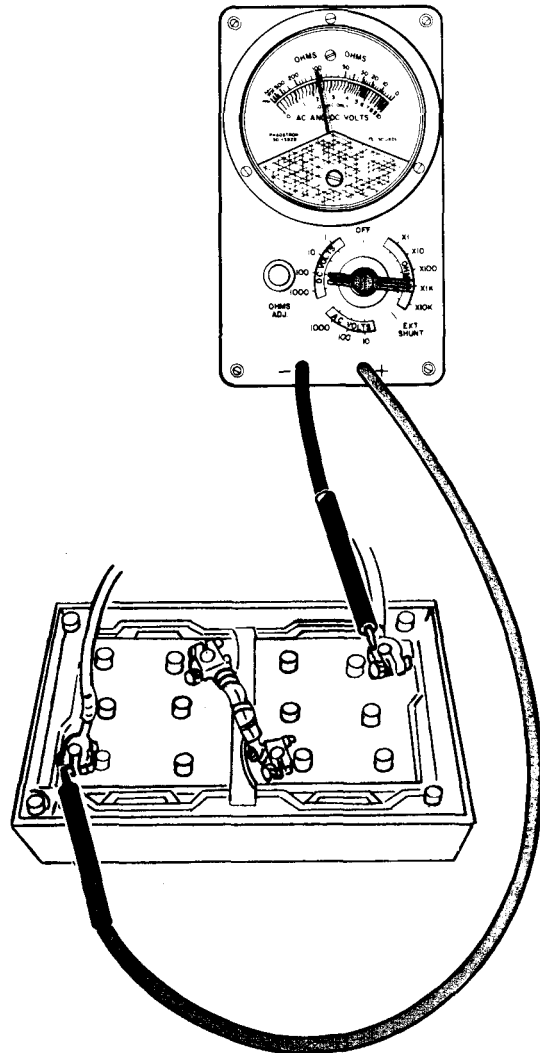

3

- If pointer falls exactly on a numbered line read multimeter as follows:
 - Read upper straight lines of AC AND DC VOLTS scale. See which straight line pointer is on

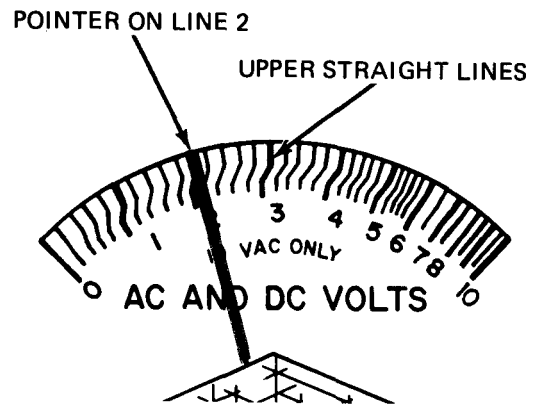

GO

Figure 29-2 (Sheet 2 of 5)

GO

SELECTOR SWITCH SETTING	INSTRUCTION
1 DC VOLTS	DIVIDE BY 10
10 DC VOLTS	USE AS IS
100 DC VOLTS	MULTIPLY BY 10

- Get multimeter reading as follows:

Step A

Read selector switch setting

Step B

From table, pick instruction that is listed next to selector switch setting

Step C

See what numbered line pointer is on

Step D

Do the instruction you picked in step B to the number in step C

Example: 100 DC VOLTS

Multiply by 10

2

$10 \times 2 = 20$ volts DC

4

- If pointer is between numbered lines read multimeter as follows:
 - a. Look at upper straight lines of AC AND DC VOLTS scale. See which two numbered lines the pointer is between. Take smaller number 2

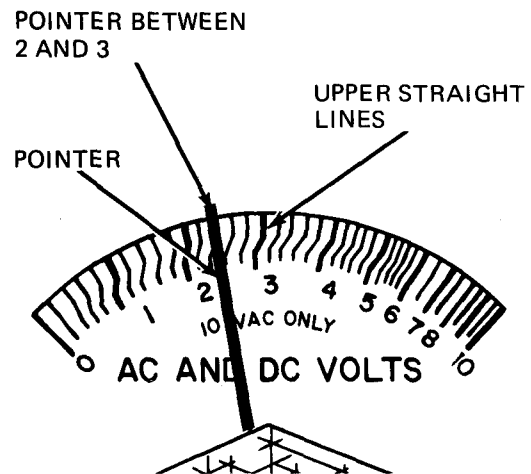

GO

Figure 29-2 (Sheet 3 of 5)

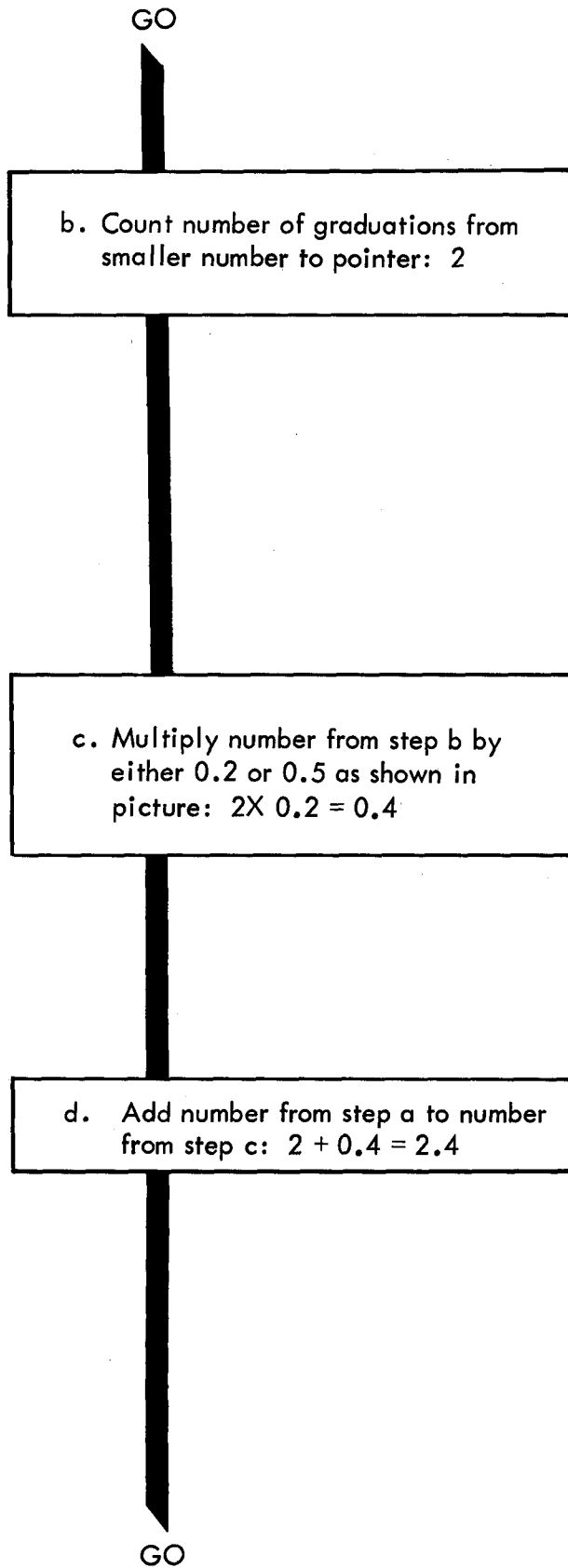

NUMBER OF GRADUATIONS FROM 2 TO POINTER IS 2

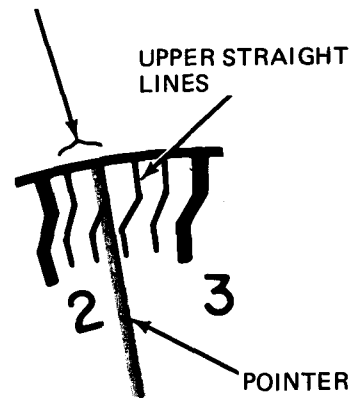

IF POINTER IS ON THIS SIDE OF LINE 6, MULTIPLY BY 0.2

IF POINTER IS ON THIS SIDE OF LINE 6, MULTIPLY BY 0.5

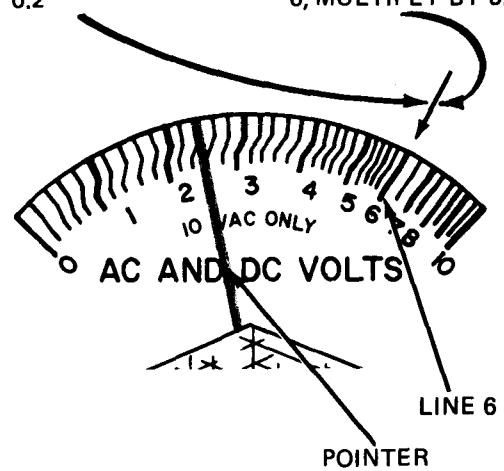

Figure 29-2 (Sheet 4 of 5)

GO

SELECTOR SWITCH	INSTRUCTION
1 DC VOLTS	DIVIDED BY 10
10 DC VOLTS	USE AS IS
100 DC VOLTS	MULTIPLY BY 10

e. Get multimeter reading as follows:

Step A

Read selector switch setting.

Step B

From table, pick instruction that is listed next to selector switch setting.

Step C

See what step 4d number is.

Step D

Do the instruction you picked in step B to the number in step C.

Example: 100 DC VOLTS Multiply by 10 2.4 10 x 2.4=24 volts DC

5

- Make circuit normal again:
 - Take both test prods off measured circuit.

Figure 29-2 (Sheet 5 of 5)

2

AC VOLTAGE TEST - To measure van input and operating voltages.

1

- Set up multimeter:

Note: The truck AC voltages measured are 208 and 120 volts. Therefore, only the 1000 AC VOLTS selector switch position is used.

- Set selector switch to 1000AC VOLTS.

Note: The OHMS ADJ knob is not used for AC voltage tests.

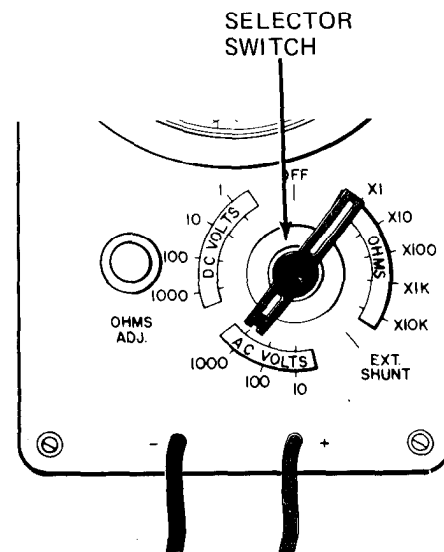

GO

TA 119927

Figure 29-3 (Sheet 1 of 5)

GO

NOTE

When you need to turn on power before measuring AC voltage, the fault isolation procedure gives the turn-on instructions.

2

- Put multimeter leads across (in parallel with) circuit being measured:
 Note: In AC voltage measurement you can hook up the test lead connections to the circuit either way. You will still get correct multimeter readings and no damage will be done to the multimeter. But, when one side of the circuit is electrical ground, it is a good idea to put the black lead on electrical ground
- Put test prod of black lead on ground side or one side of circuit being measured. Put test prod of red lead on other side of circuit being measured.

GO

NOTE: MULTIMETER SHOWN MEASURING 120 VOLTS AC VAN CEILING LIGHT VOLTAGE

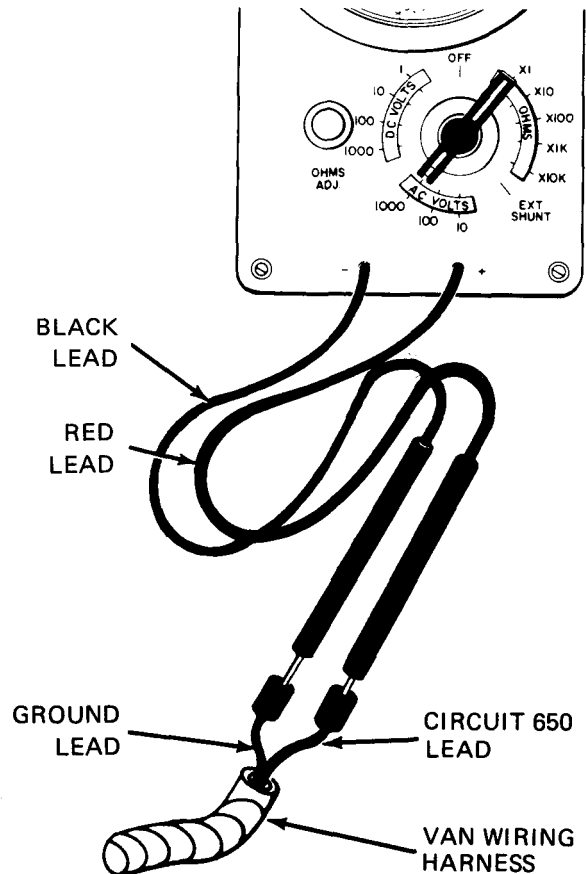

TA 119928

Figure 29-3 (Sheet 2 of 5)

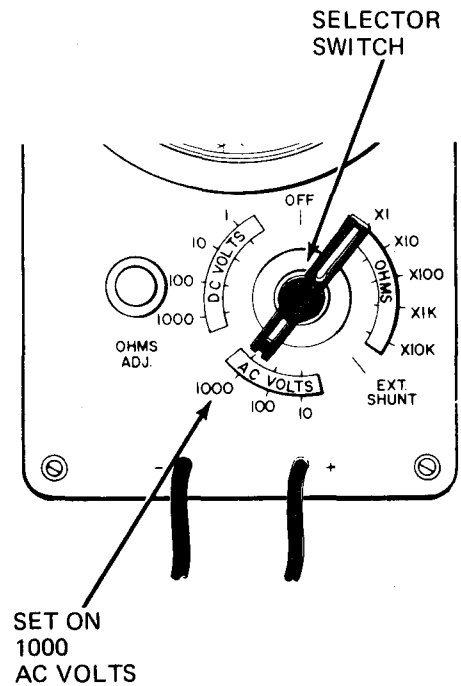
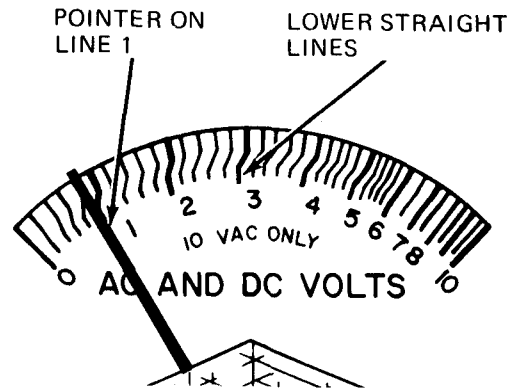
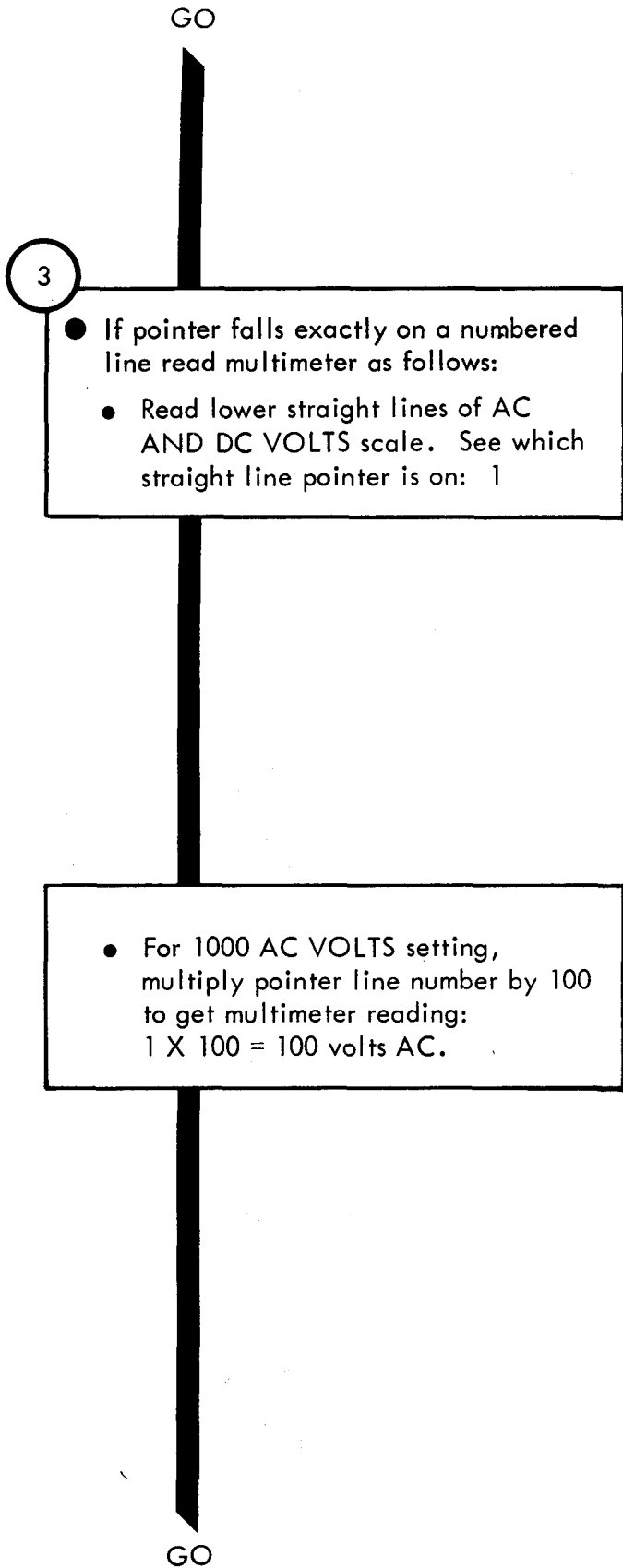

TA 119929

Figure 29-3 (Sheet 3 of 5)

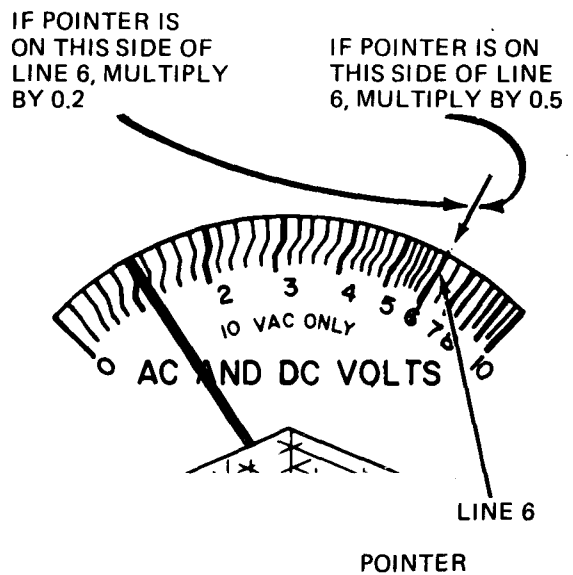
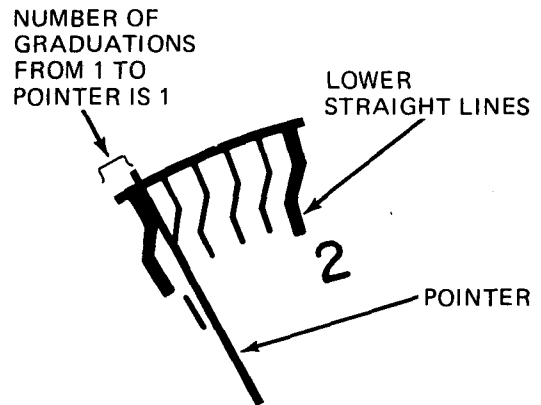
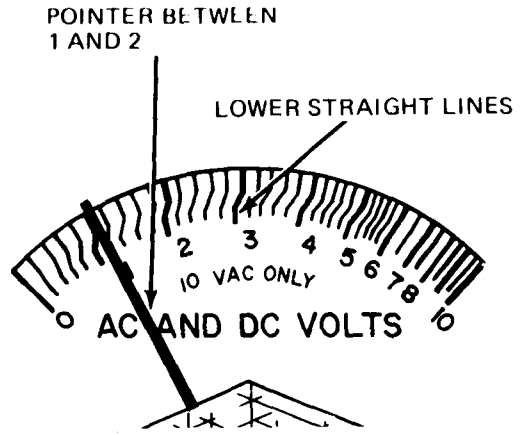
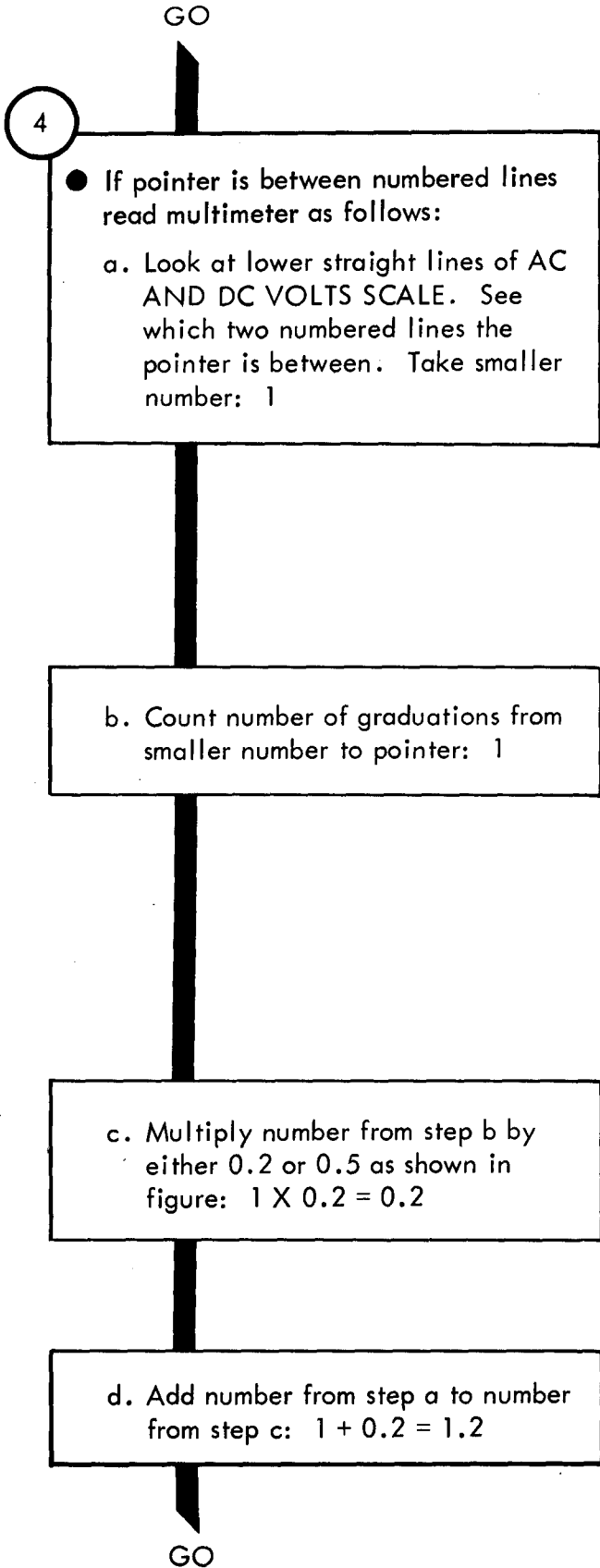

TA 119930

Figure 29-3 (Sheet 4 of 5)

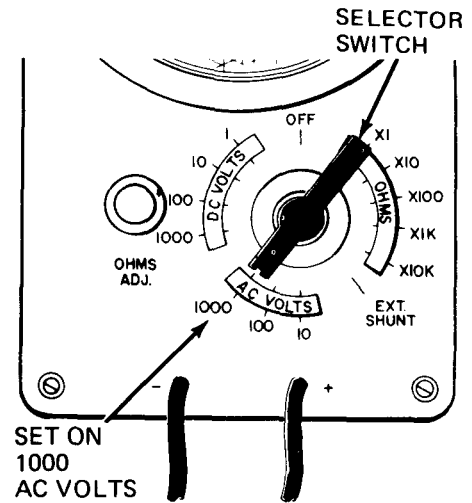
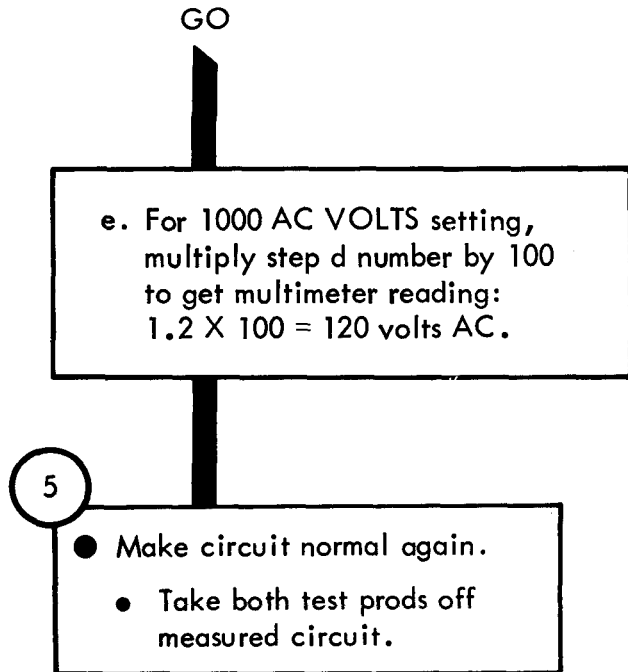
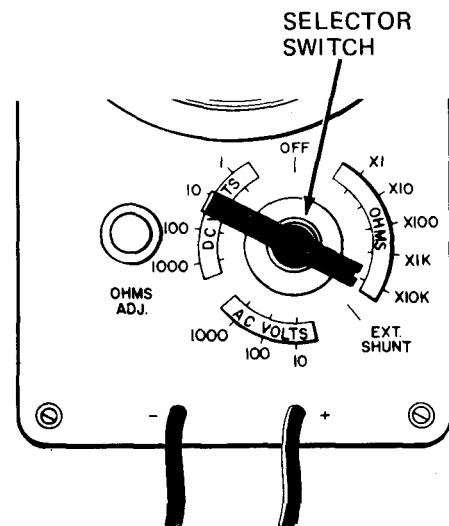
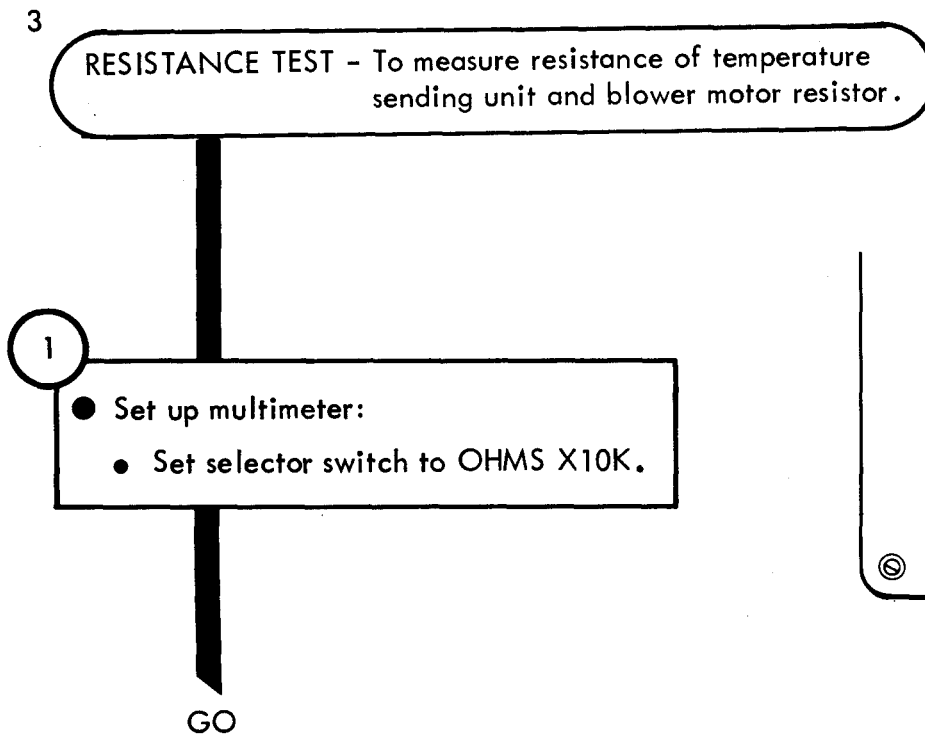

Figure 29-3 (Sheet 5 of 5)



TA 119931

Figure 29-4 (Sheet 1 of 10)

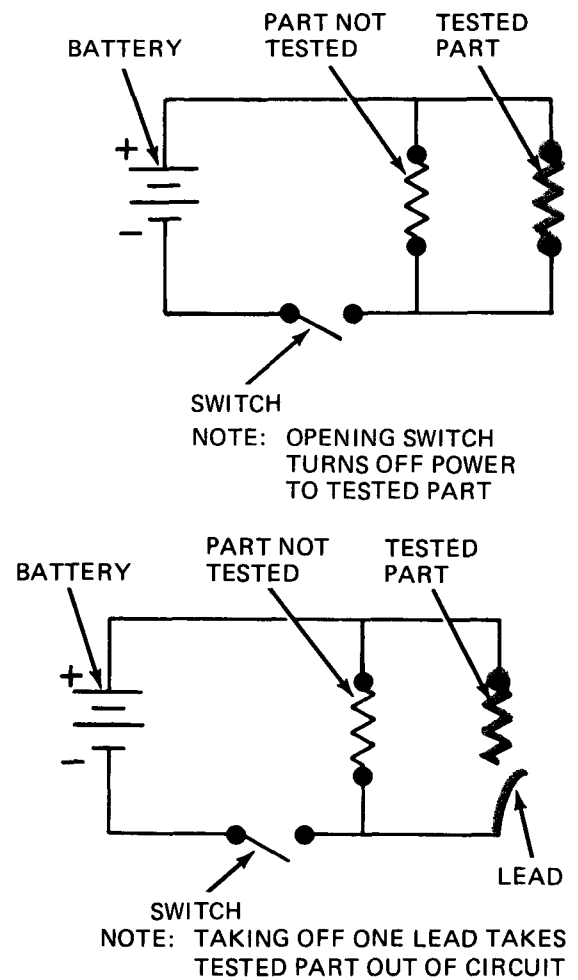
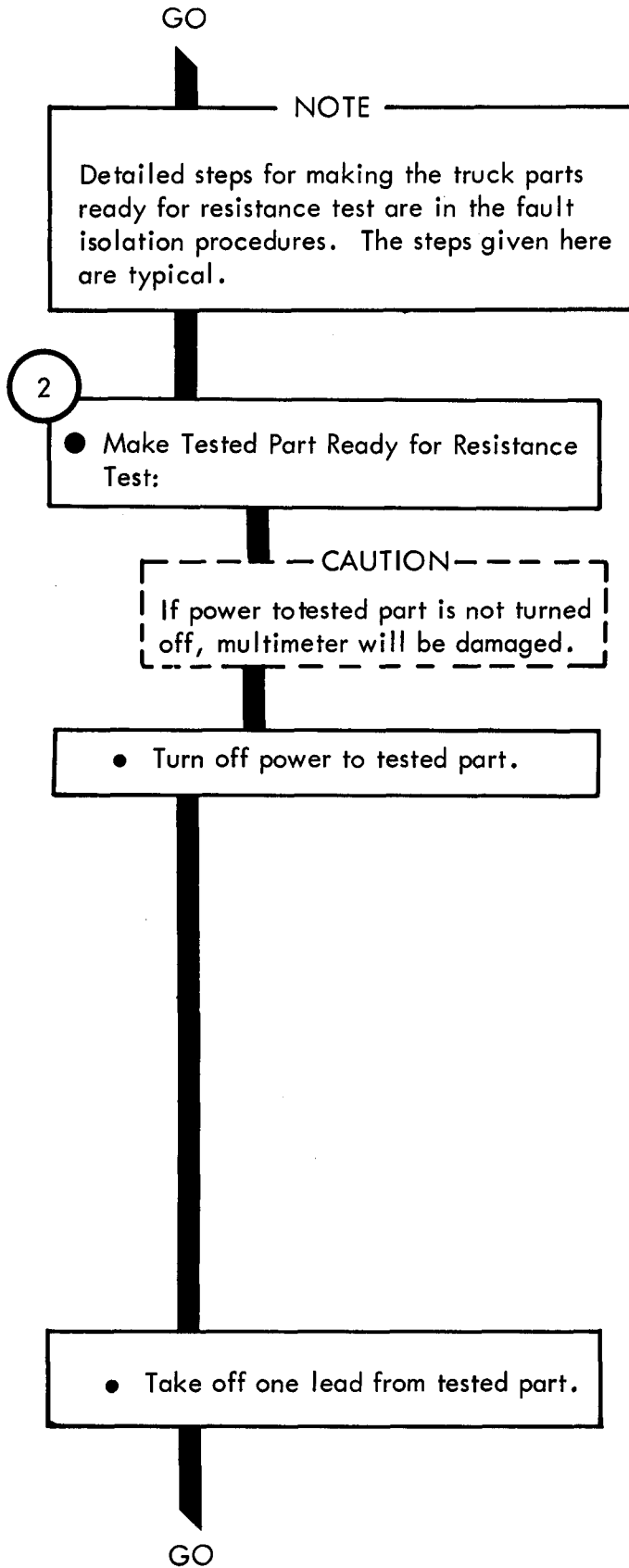

Figure 29-4 (Sheet 2 of 10)

TA 119932

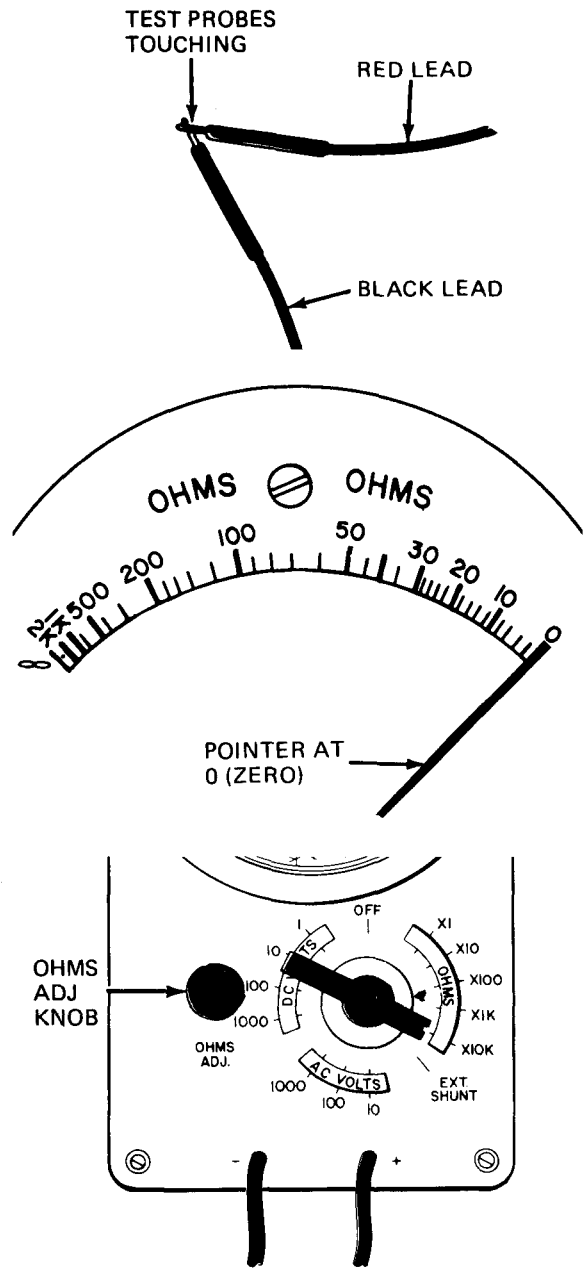
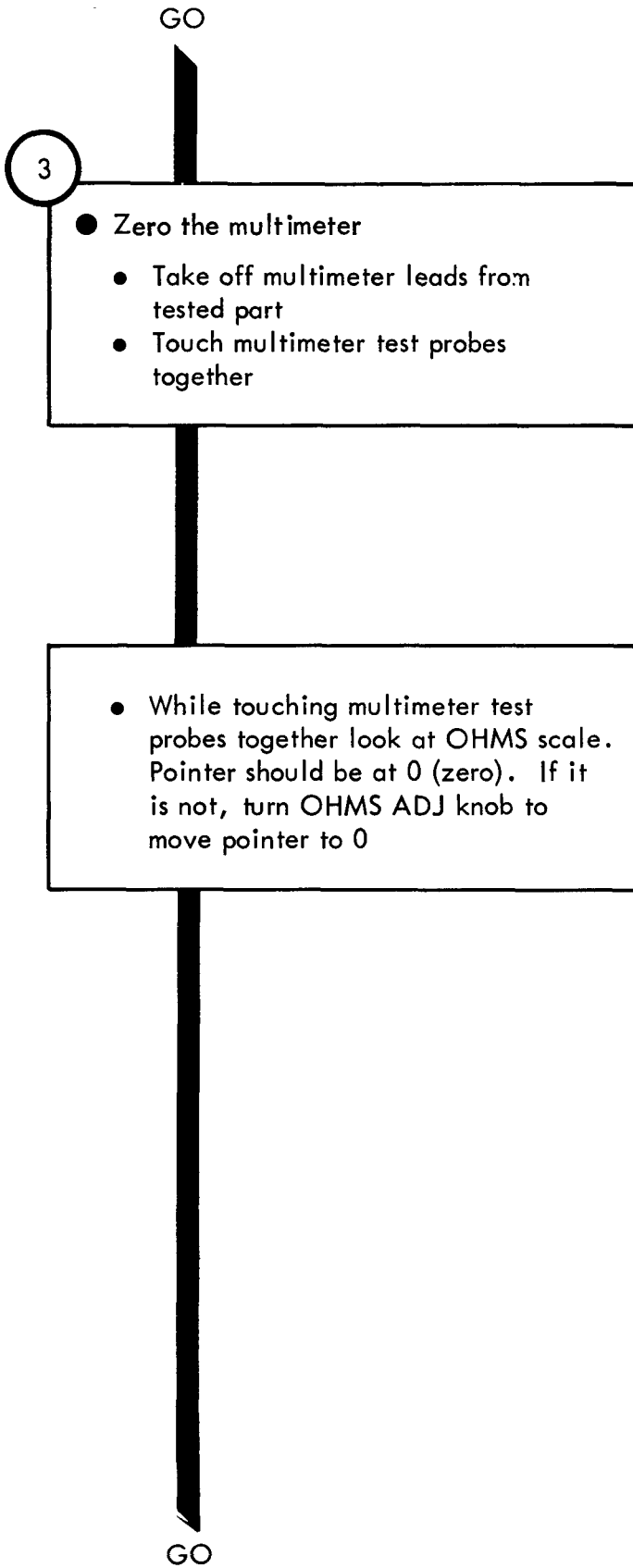

Figure 29-4 (Sheet 3 of 10)

GO

4

- Put multimeter leads across tested part
 - Put one test prod on one terminal of tested part
 - Put other test prod on other terminal of test part

NOTE

Zero the multimeter each time you turn the selector switch knob to another position (See step 3)

GO

NOTE: MULTIMETER SHOWN MEASURING RESISTANCE OF A COLD START RESISTOR.

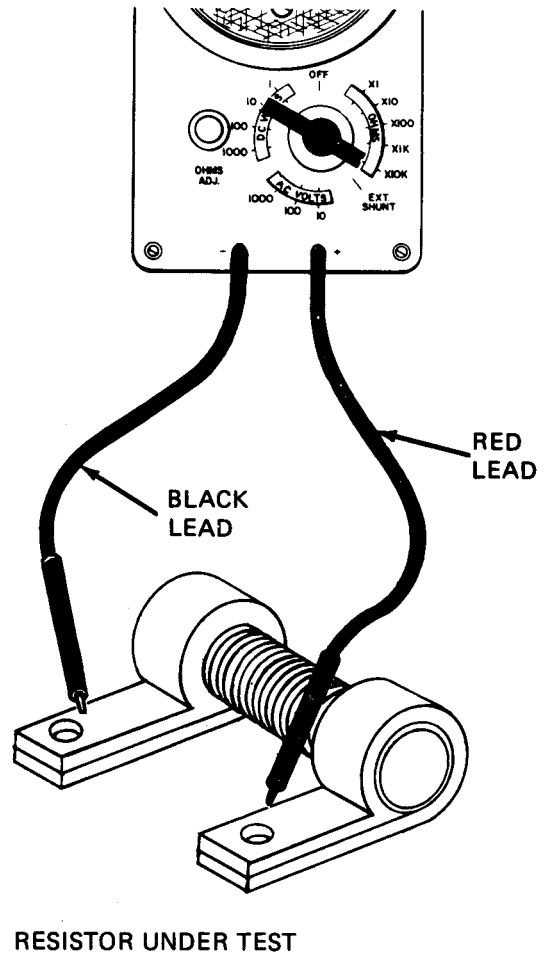
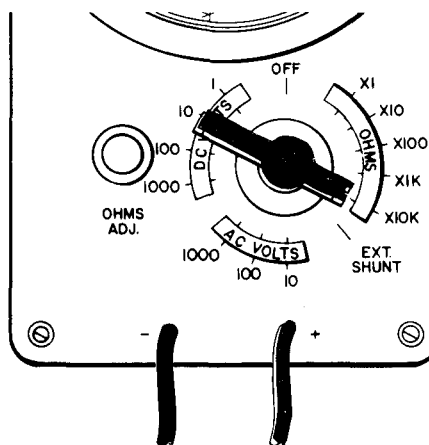
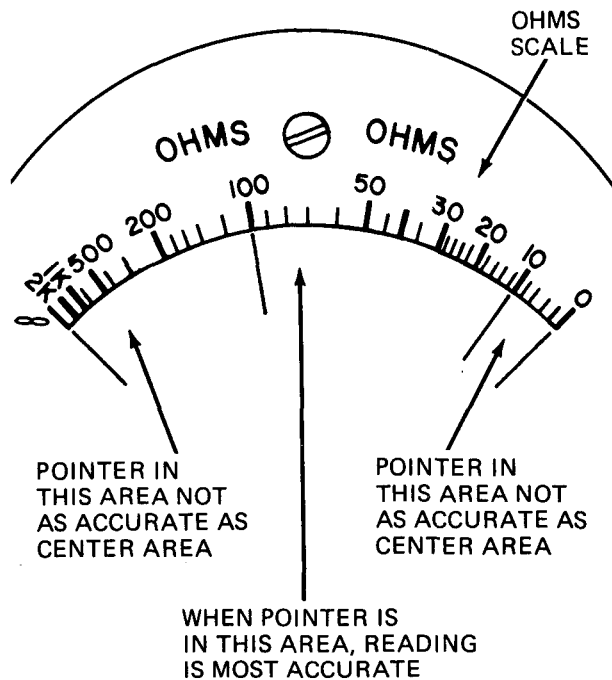

Figure 29-4 (Sheet 4 of 10)

GO

5

- Get the most accurate multimeter reading as follows
- Note: The closer the multimeter pointer is to the center of the OHMS scale, the more accurate the reading
- Note position of pointer on OHMS scale. Turn selector switch knob to left while looking at pointer. Try to find selector switch knob position that gives most centered pointer position



NOTE: MOVING SELECTOR SWITCH KNOB TO LEFT MOVES POINTER TO LEFT

GO

Figure 29-4 (Sheet 5 of 10)

GO

- You may overshoot most centered pointer position. If you do, turn selector switch knob to right to put pointer in most centered position

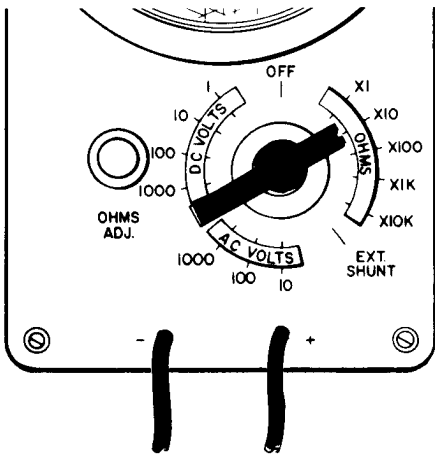

NOTE: MOVING SELECTOR SWITCH KNOB TO RIGHT MOVES POINTER TO RIGHT

- Pointer will stay in right area if resistance is less than 10 ohms. Pointer will stay in left area if resistance is more than 1,000,000 ohms
- Leave selector switch in position that puts pointer in most centered position

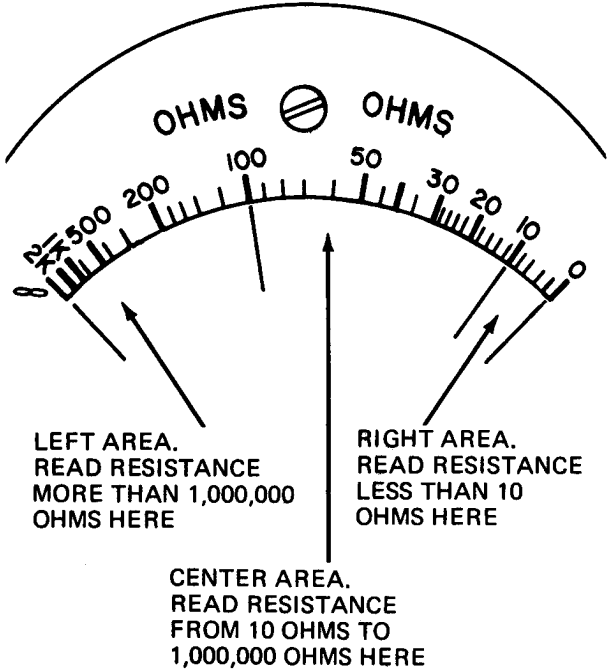

GO

Figure 29-4 (Sheet 6 of 10)

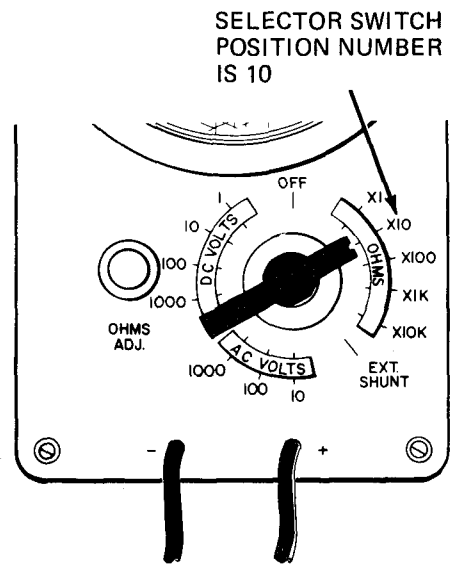
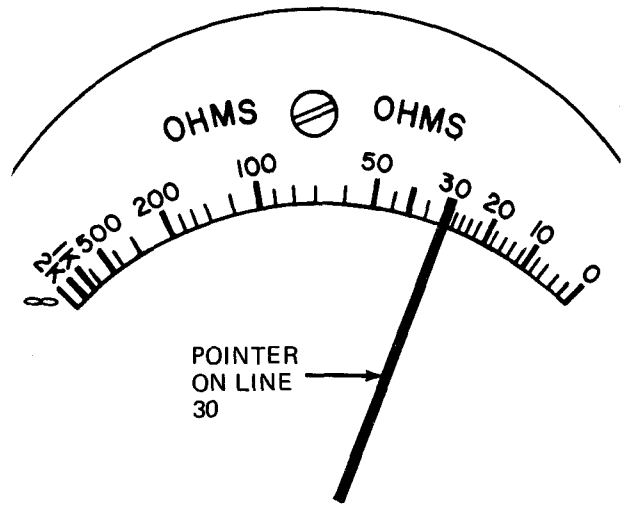
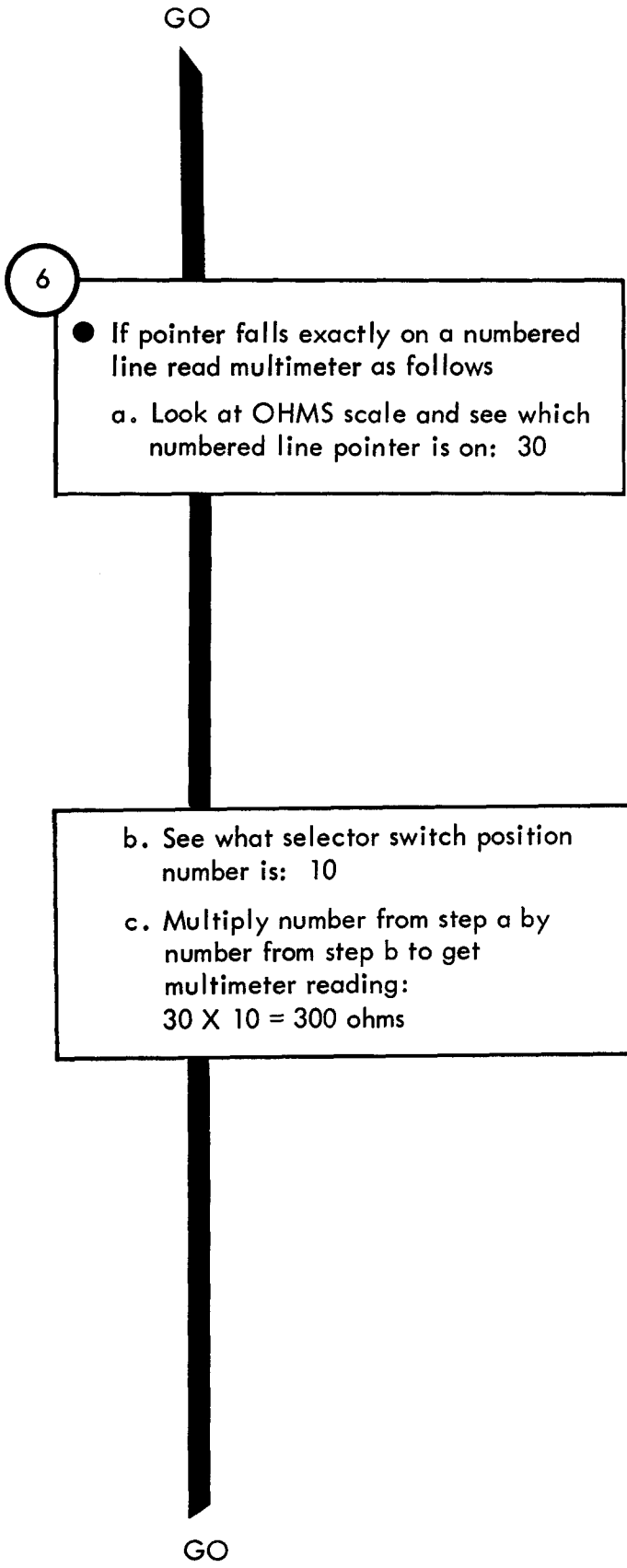
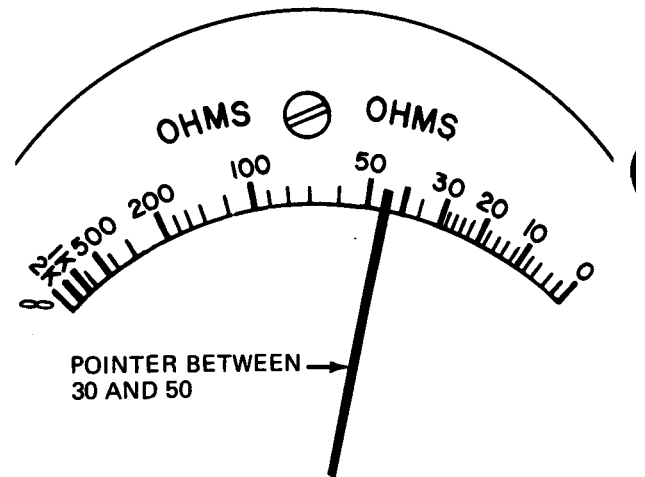
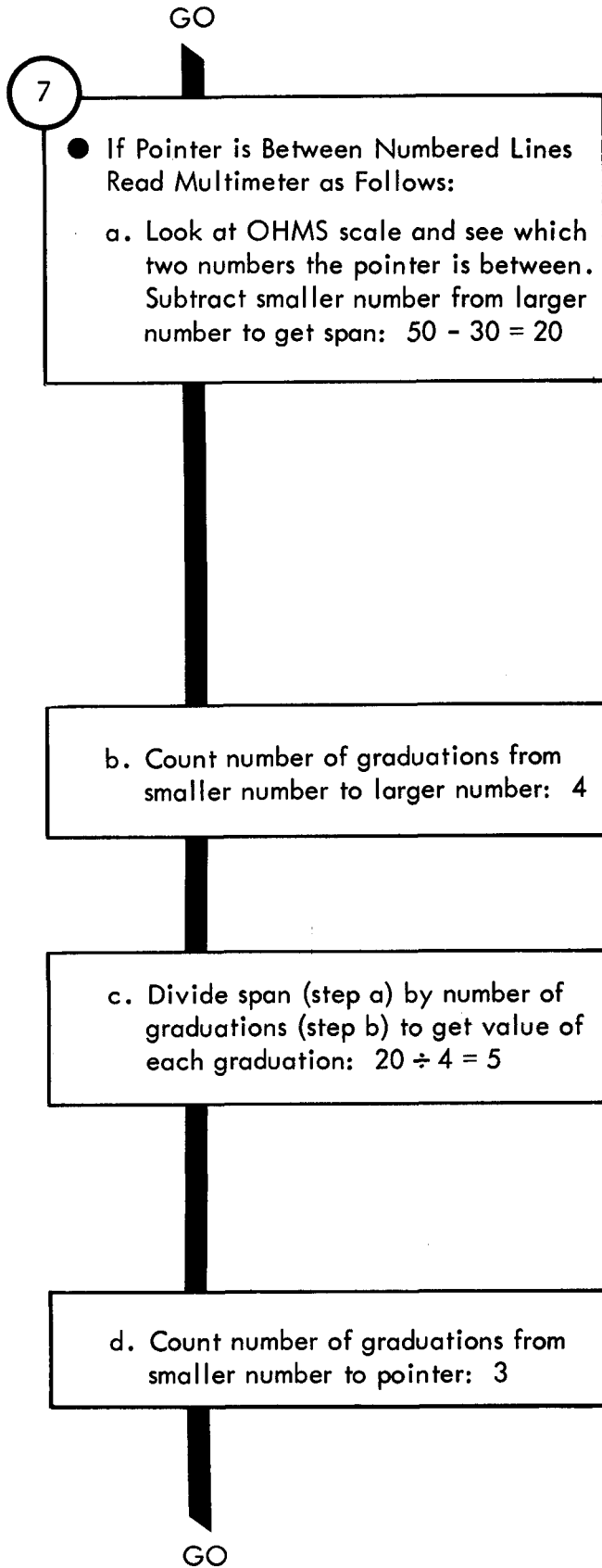
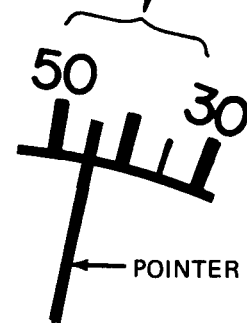

Figure 29-4 (Sheet 7 of 10)



NUMBER OF GRADUATIONS FROM 30 TO 50 IS 4



NUMBER OF GRADUATIONS FROM 30 TO POINTER IS 3

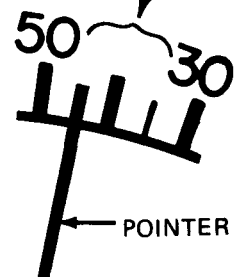

Figure 29-4 (Sheet 8 of 10)

TA 119938

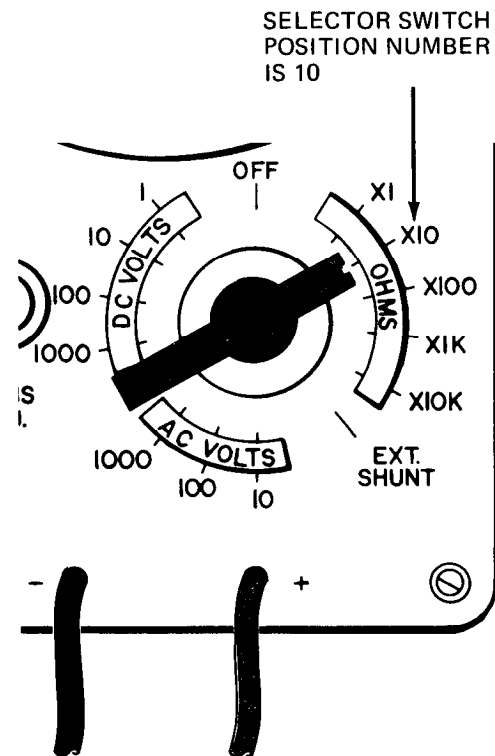
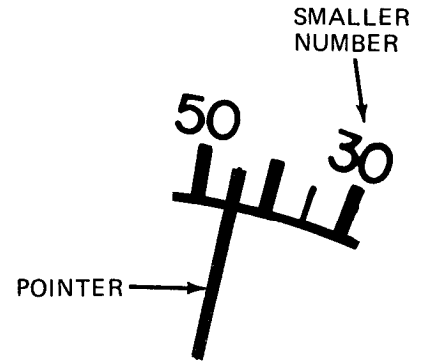
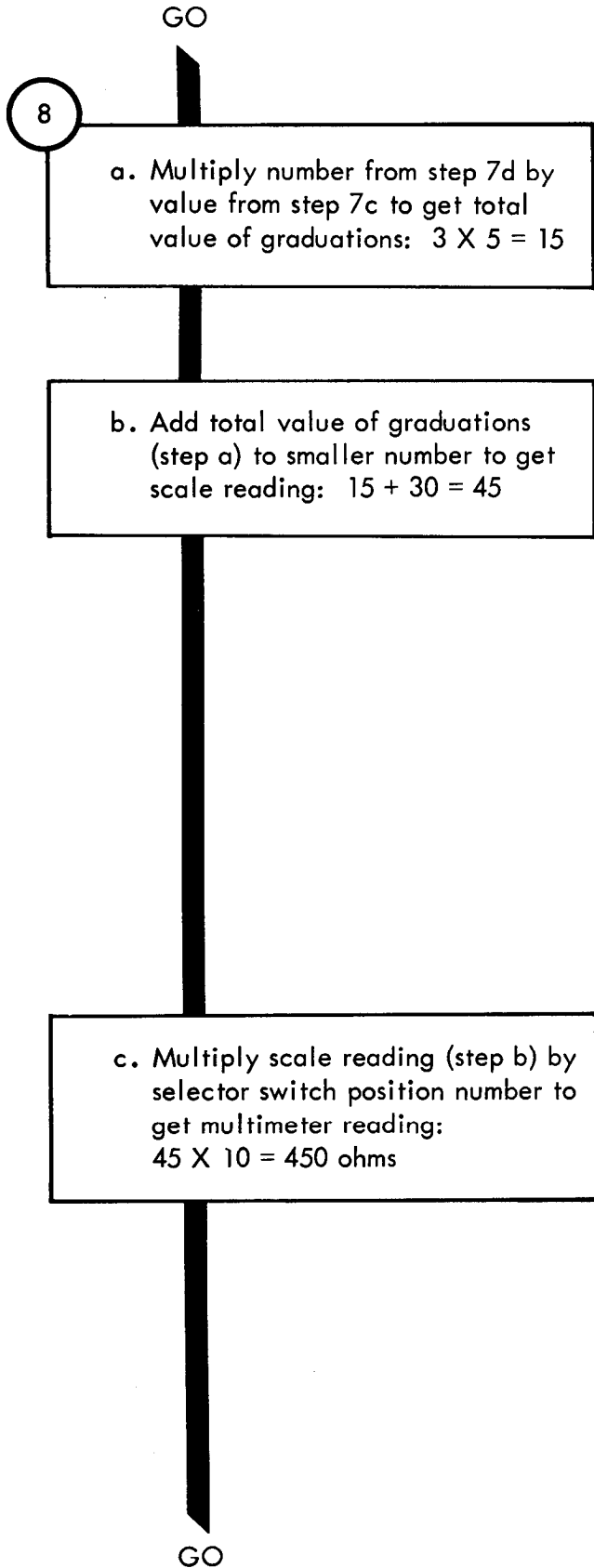

Figure 29-4 (Sheet 9 of 10)

GO

9

- Put isolated tested part back in circuit:
 - Take off both test prods from across tested part
 - Put lead back on tested part

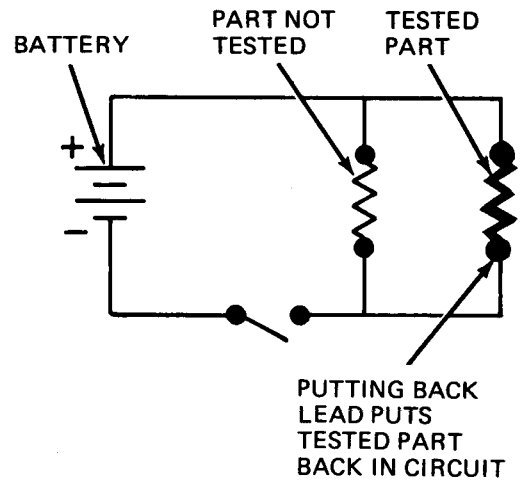

Figure 29-4 (Sheet 10 of 10)

4

CONTINUITY TEST - To check for breaks in a circuit, such as switch, lamp, or electrical cable circuits

1

- Set Up Multimeter
 - Set selector switch to OHMS X 1.

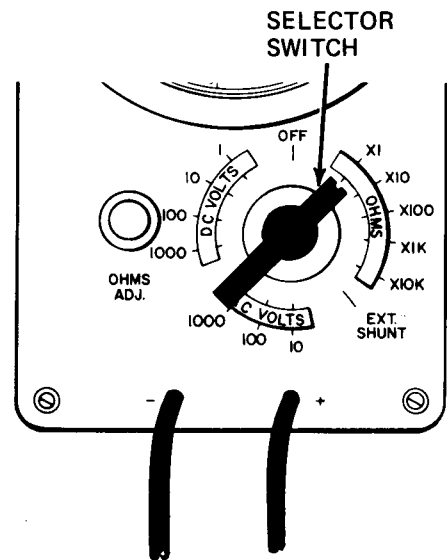

GO

Figure 29-5 (Sheet 1 of 4)

GO

NOTE

Detailed steps for making the truck circuits ready for continuity tests are in the fault isolation procedures. The steps given here are typical

2

- Make tested circuit ready for continuity test

CAUTION

If power to tested part is not turned off, multimeter will be damaged

- Turn off power to tested circuit

- Take tested wire out of circuit

GO

SETTING LIGHT SWITCH MAIN LEVER TO OFF TURNS OFF POWER TO LIGHT CIRCUIT

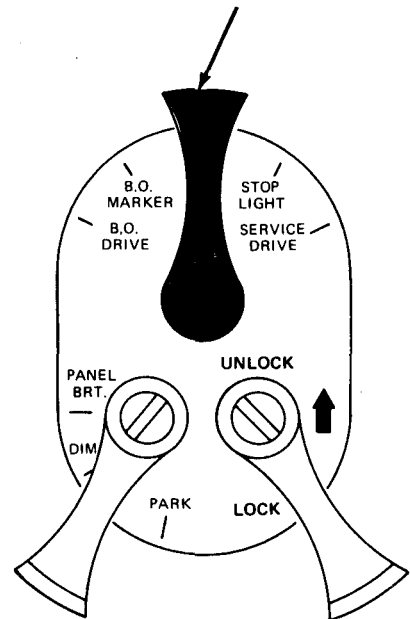

PLUG ON EACH END OF TRAILER CONNECTING CABLE REMOVED FROM MATING RECEPTACLE TO TAKE TESTED WIRE OUT OF CIRCUIT FOR CONTINUITY TEST

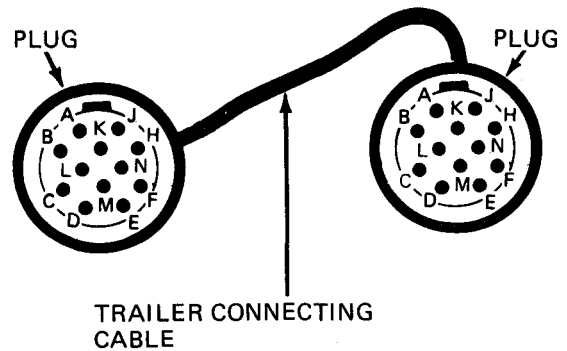
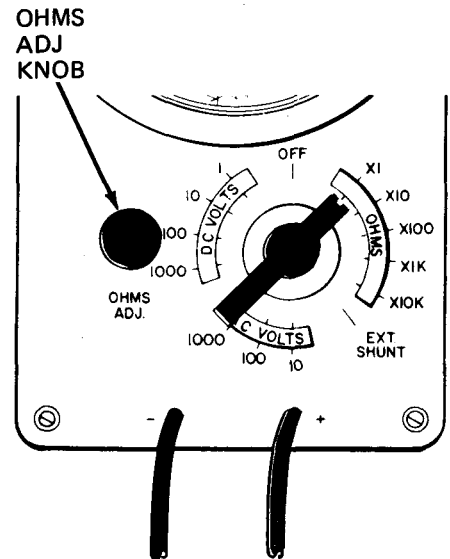
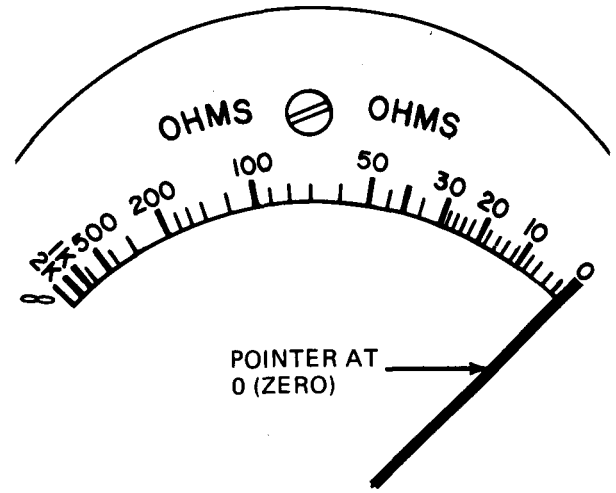
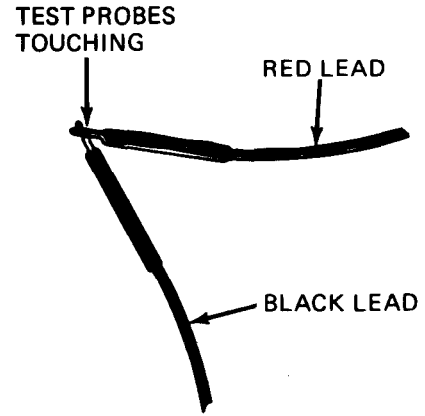
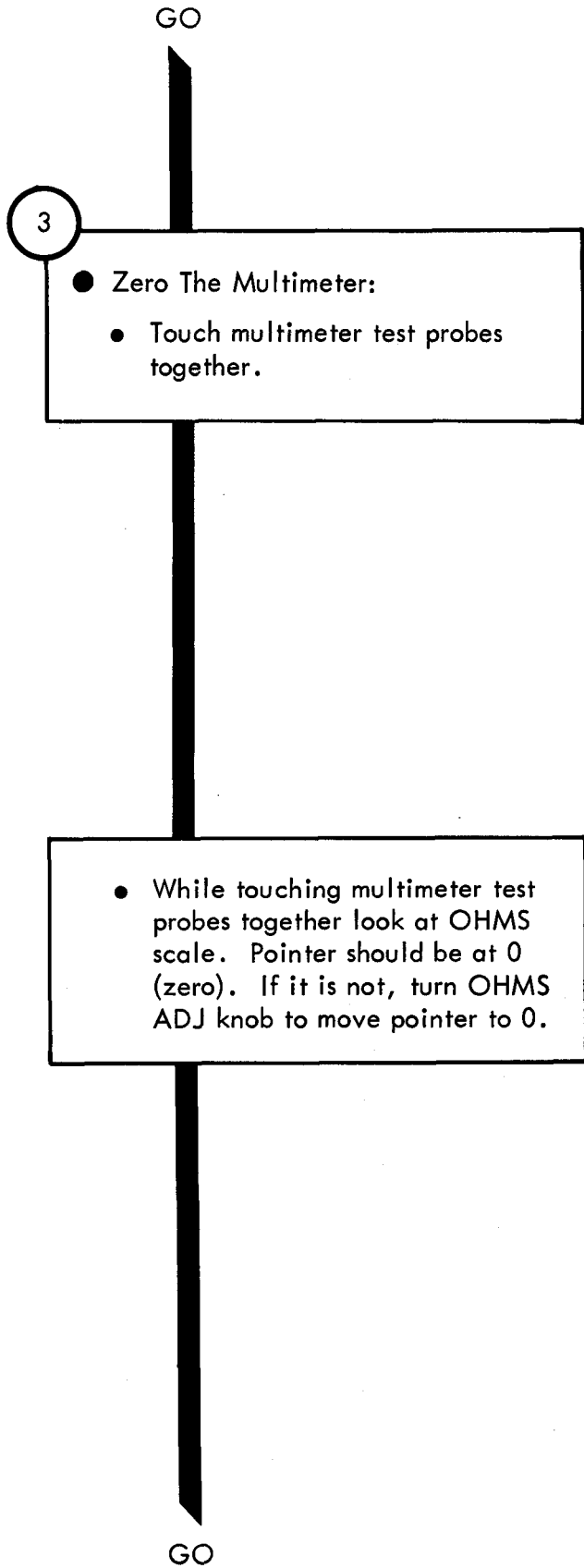

Figure 29-5 (Sheet 2 of 4)

TA 119941



TA 119942

Figure 29-5 (Sheet 3 of 4)

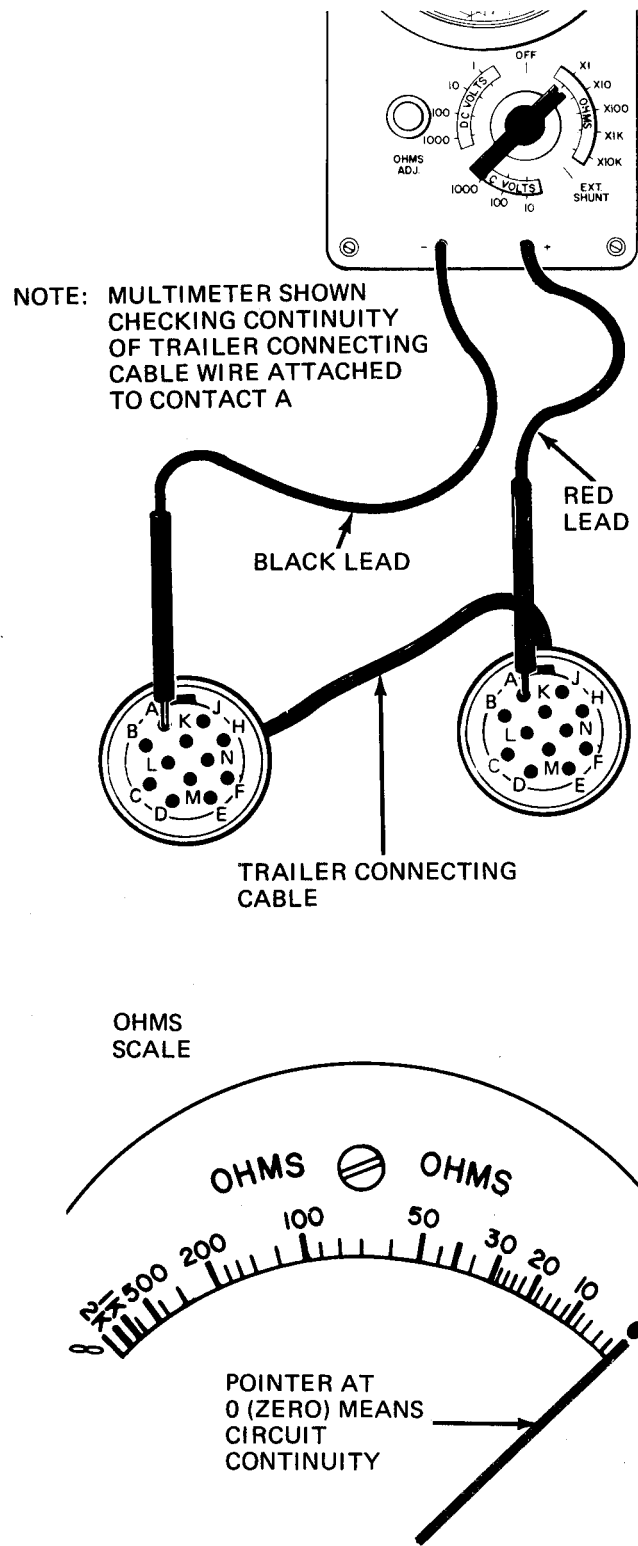
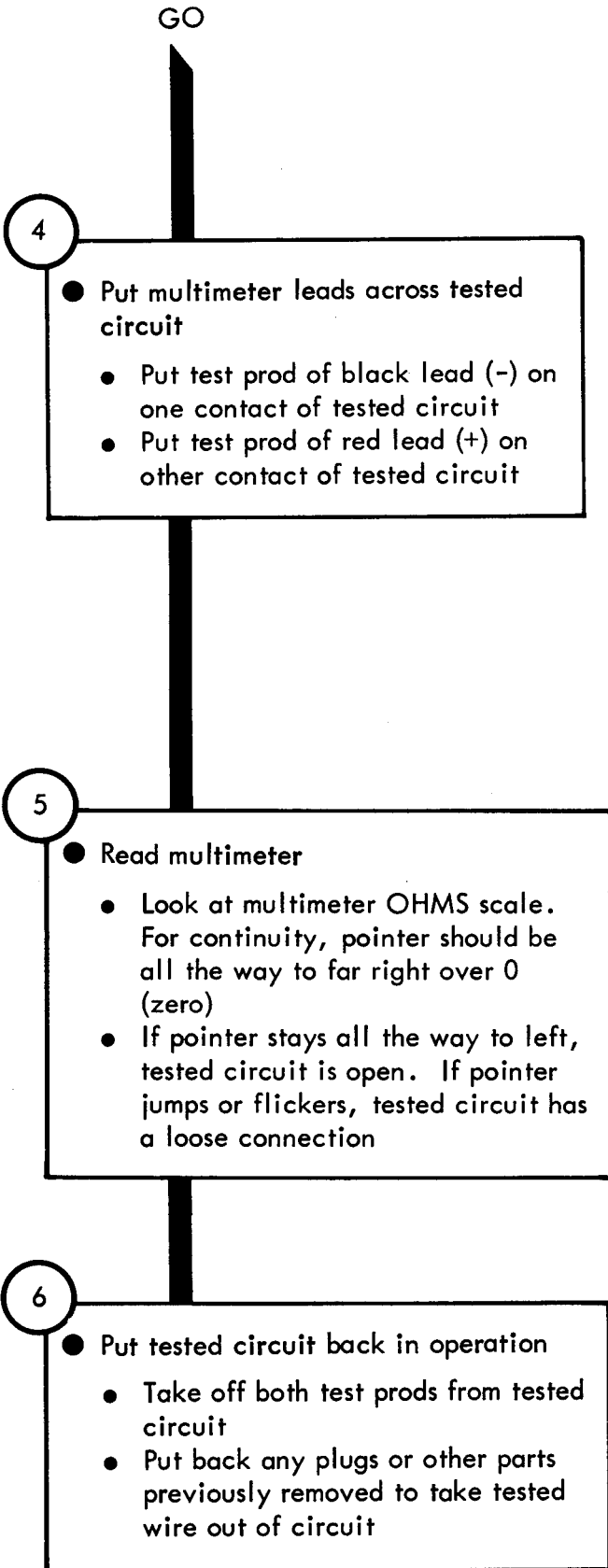

Figure 29-5 (Sheet 4 of 4)

TA 119943

Test

5 SHORT TEST - To check for shorts in electrical cables.

NOTE

A short (or short circuit) happens when two circuits that should not be connected have metal-to-metal contact with each other. A short also happens when a circuit that should not touch electrical ground has metal-to-metal contact with ground.

- 1
- Set Up Multimeter:
 - Set selector switch to OHMS X 10K.

NOTE

Detailed steps for making the truck circuits ready for short test are in the fault isolation procedures. The steps given here are typical.

- 2
- Make Tested Circuits Ready for Short Test:

CAUTION

If power to tested part is not turned off, multimeter will be damaged

GO

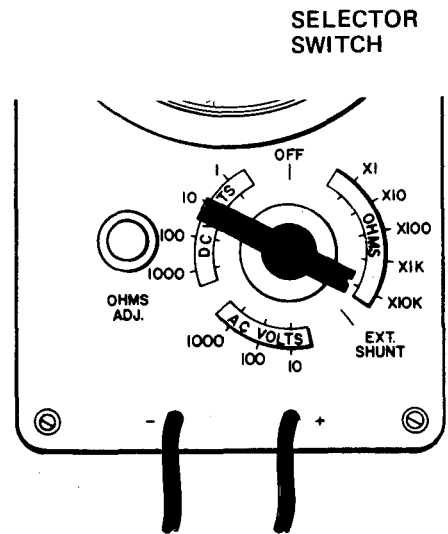
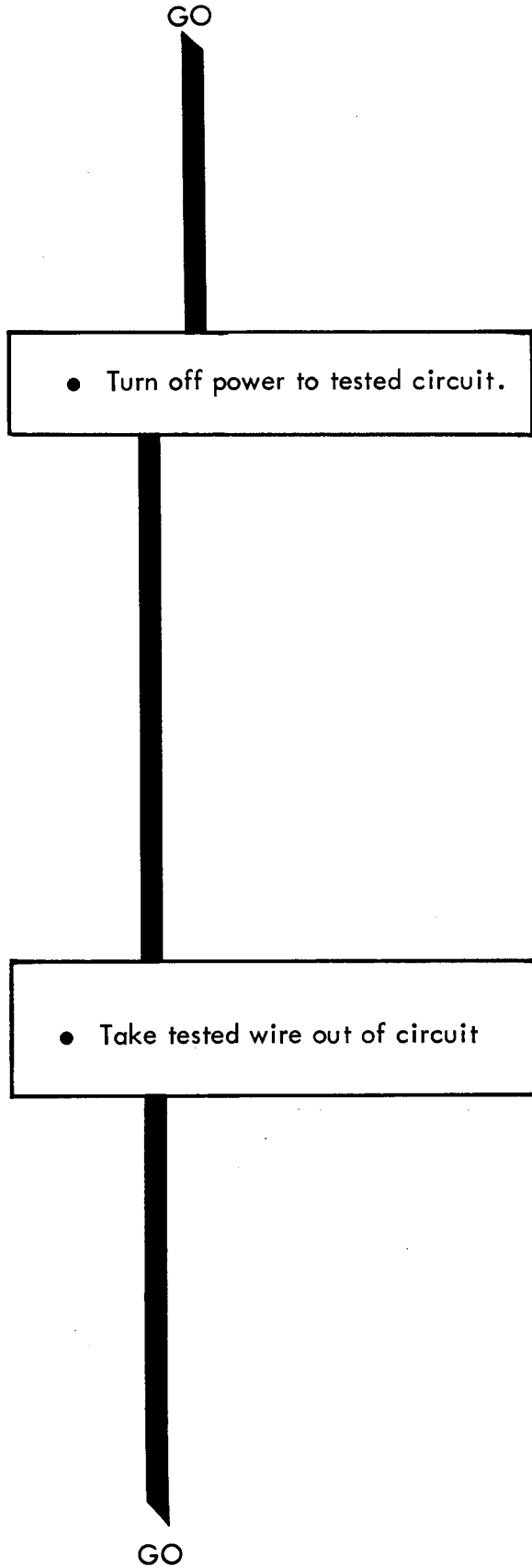
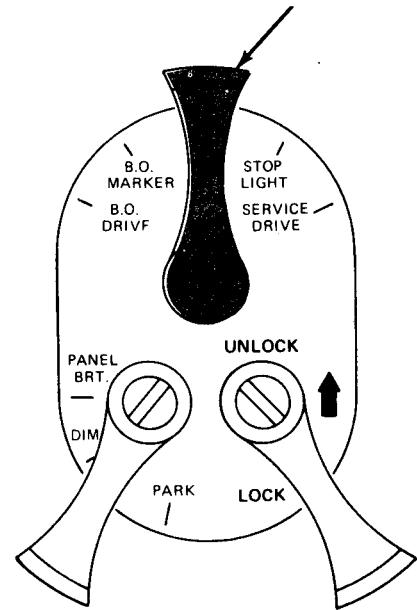

Figure 29-6 (Sheet 1 of 5)



SETTING LIGHT SWITCH MAIN LEVER TO OFF TURNS OFF POWER TO LIGHT CIRCUITS.



PLUG ON EACH END OF TRAILER CONNECTING CABLE REMOVED FROM MATING RECEPTACLE TO TAKE TESTED WIRE OUT OF CIRCUIT FOR SHORT TEST

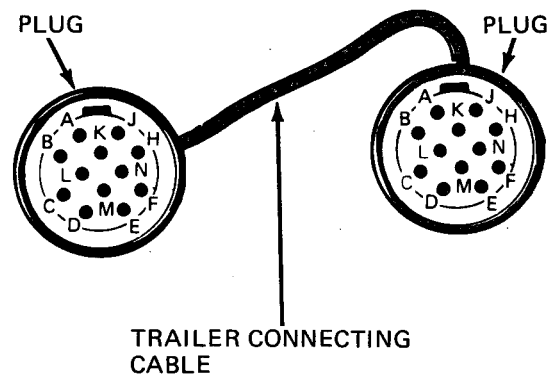

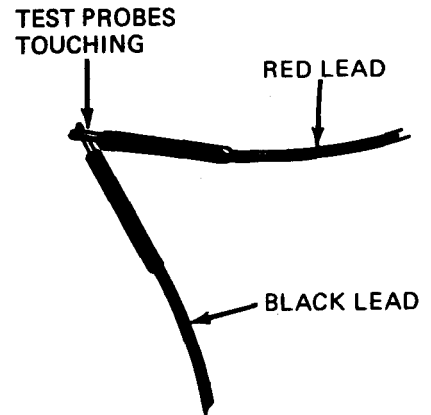
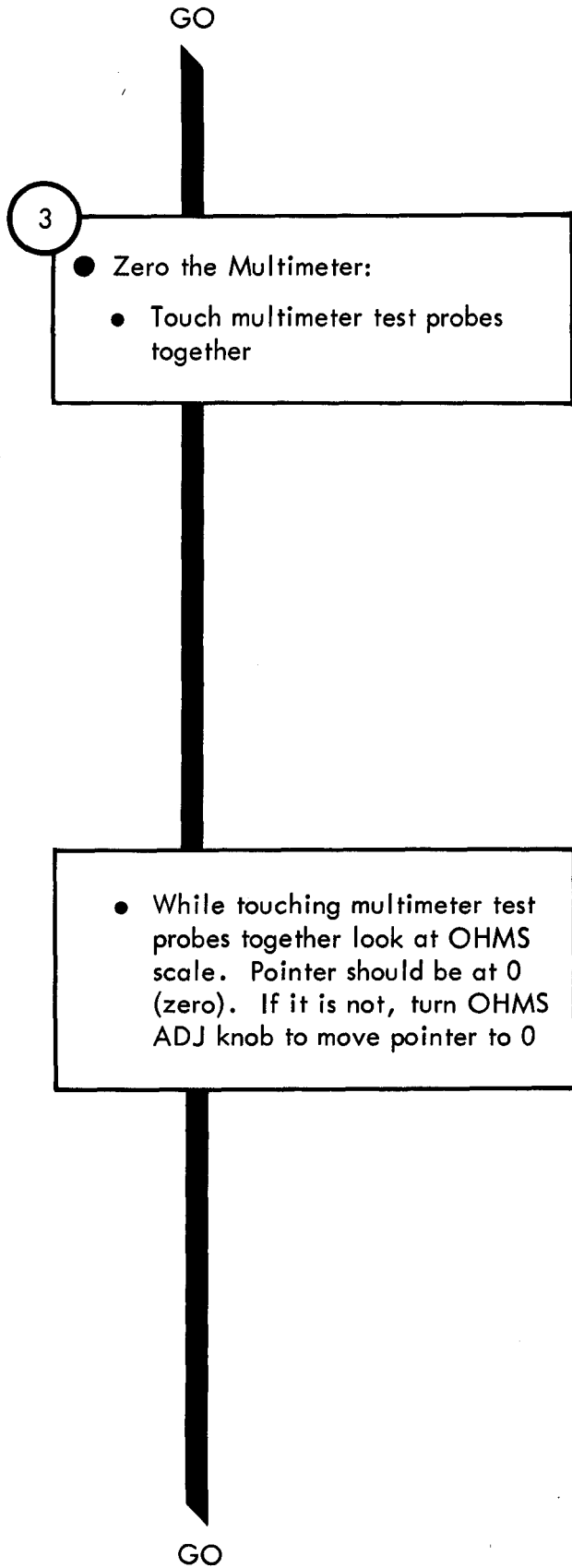

TS 260-20-403

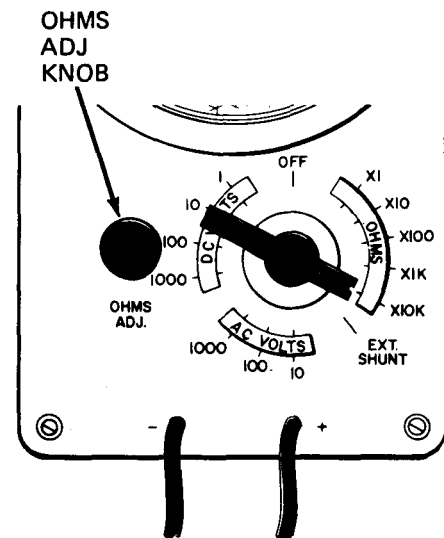
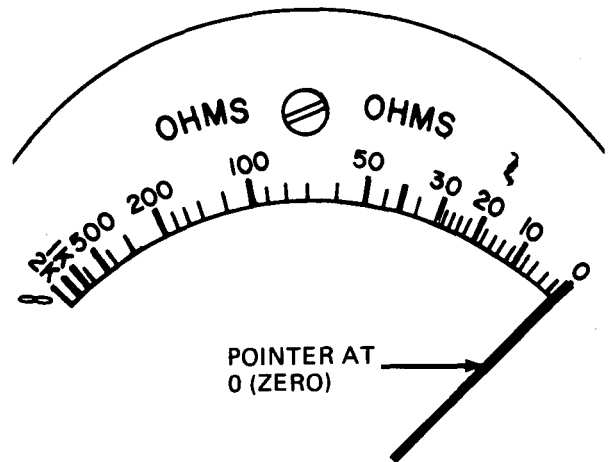

TA 119946

Figure 29-6 (Sheet 3 of 5)

GO

4

- Put multimeter leads across tested circuits
- To test for short between two wires, put test probes on contacts of both wires

GO

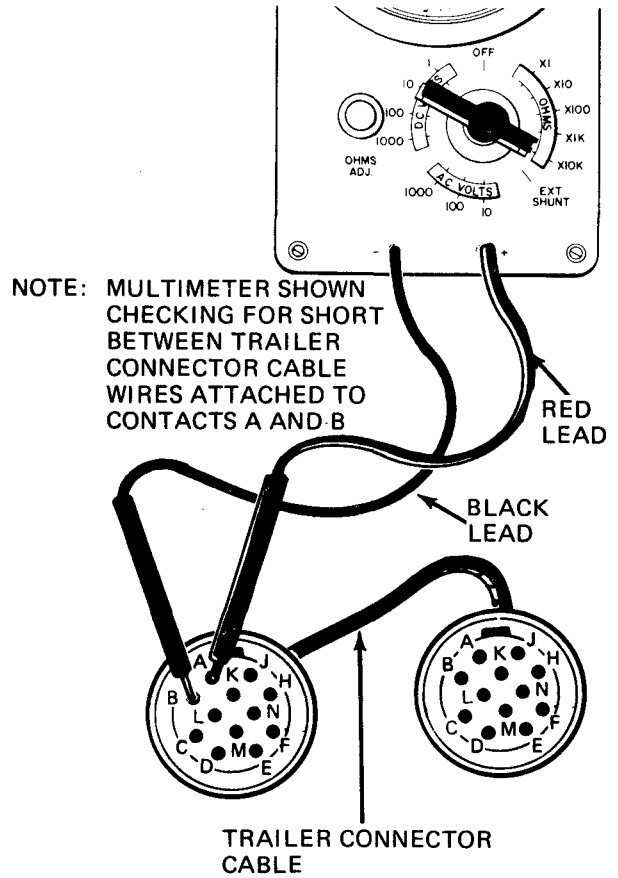

Figure 29-6 (Sheet 4 of 5)

GO

● To test for short between a wire and ground, put test probes on wire contact and ground

5

● Read multimeter

- Look at multimeter OHMS scale. If pointer stays all the way to far left without moving, circuits are not shorted
- If pointer moves all the way to far right over 0 (zero), circuits are shorted. If pointer jumps or flickers, circuits are sometimes shorted

6

● Put tested circuit back in operation

- Take off test prods from contacts and ground
- Put back any plugs or other parts previously removed to take tested wire out of circuit

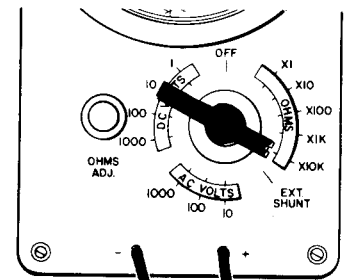

NOTE: MULTIMETER SHOWN CHECKING FOR SHORT BETWEEN TRAILER CONNECTOR CABLE WIRE ATTACHED TO CONTACT B AND GROUND

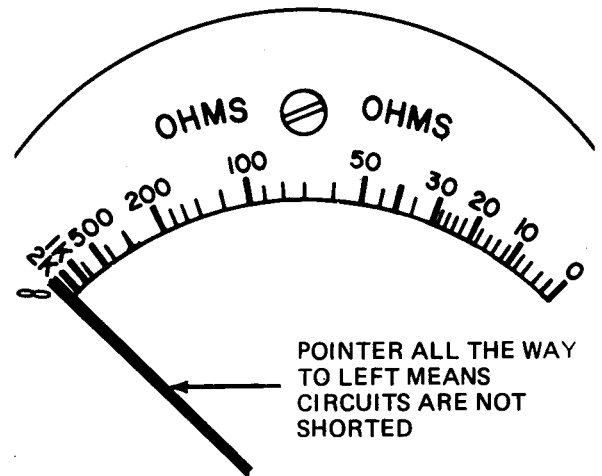
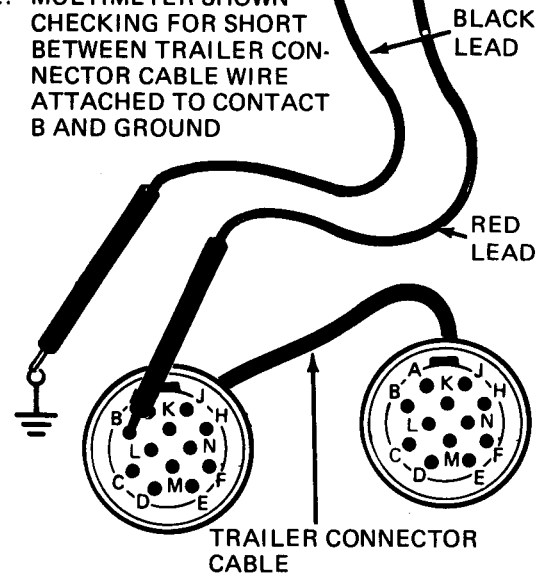
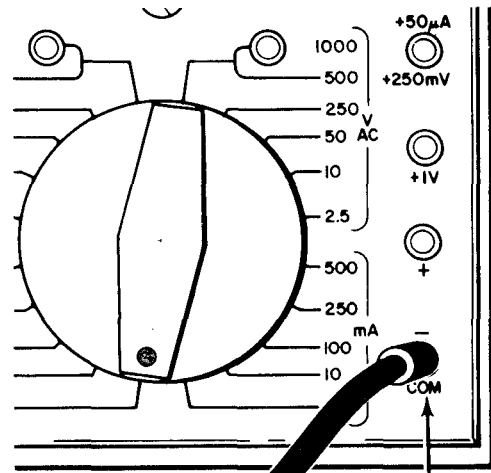

Figure 29-6 (Sheet 5 of 5)

1 DC VOLTAGE TEST - To measure battery voltage, charging system output, and voltage drops at various test points

- 1
- Set up multimeter test leads
 - Put jack plug of black (-) test lead into COM - jack
- Note: The highest truck DC voltage that is measured is about 28 volts. Therefore, the multimeter red (+) lead is never put into the 1000 VDC jack
- See table to find out which jack to put red (+) lead into. Table shows which jack to use when normal value of measured voltage is known or unknown



BLACK LEAD
THIS JACK IS THE METER CIRCUIT'S COMMON GROUND

IF NORMAL VALUE OF VOLTAGE BEING MEASURED IS THIS:	PUT RED LEAD INTO THIS JACK ON RIGHT SIDE OF MULTIMETER:
0 TO 230 MILLIVOLTS	+50 µA +250mV
230 MILLIVOLTS TO 0.8 VOLTS	+1V
0.8 TO 2 VOLTS	+
2 TO 8 VOLTS	+
8 TO 40 VOLTS	+
UNKNOWN	+

GO

Figure 29-7

MULTIMETER SIMPSON 160 TEST PROCEDURES

GENERAL INSTRUCTIONS

- Check that multimeter is ready for use
 - Calibration label - Check to be sure multimeter has been calibrated in the last 12 months
 - Meter - Glass and pointer not broken. Pointer should be resting over zero mark at left side of scales
 - Jack sockets - Open and dirt free
 - Batteries - Not corroded or leaking
Put in right
-
- Cables - No cuts, sharp kinks or bad fraying
 - Jack plugs - Tight on cable, prods clean
 - Test prods - Tight on cable, tip free of paint or anything that might be an insulator
 - Switches - Work freely without binding or scraping

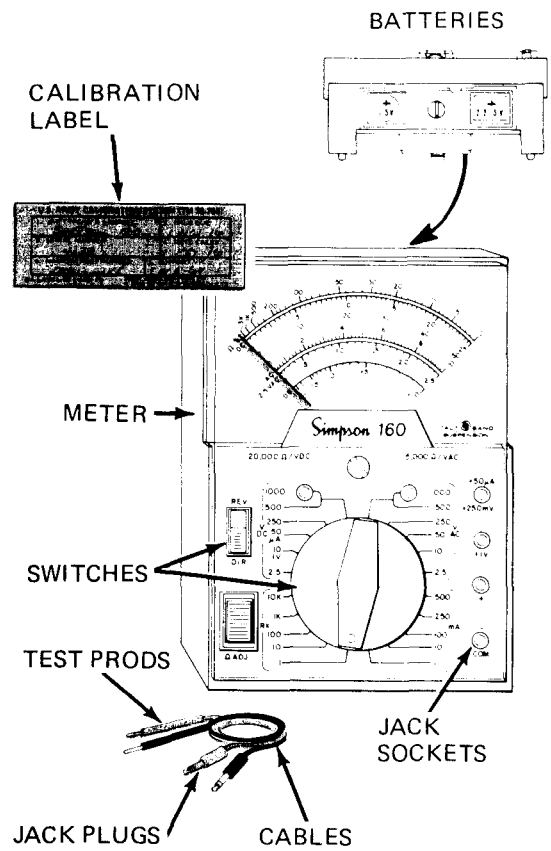
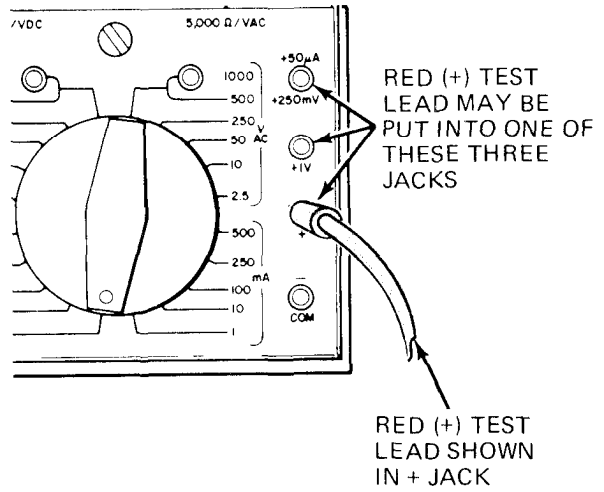

Figure 29-8 (sheet 1 of 13)

TA 119949

GO

● Put jack plug of red (+) test lead into jack receptacle you picked on right side of multimeter



2

● Set up multimeter switches
 Note: The Ω ADJ knob is not used for DC voltage tests
 ● Set REV DIR switch to DIR

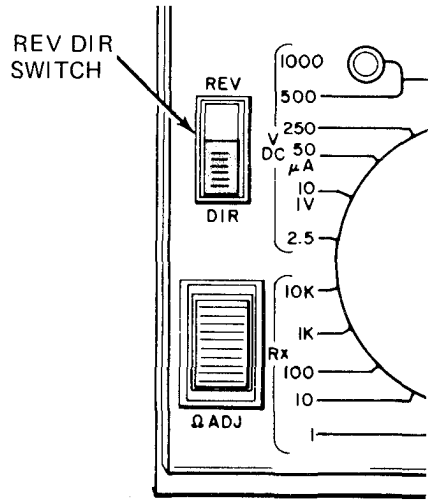

● See table to find out setting of function/range switch. Table shows switch setting when normal value of measured voltage is known or unknown

IF NORMAL VALUE OF VOLTAGE BEING MEASURED IN THIS:	SET FUNCTION/RANGE SWITCH TO:
0 TO 230 MILLIVOLTS	50 μ A
230 MILLIVOLTS TO 0.8 VOLTS	10 1V
0.8 TO 2 VOLTS	2.5
2 TO 8 VOLTS	10 1V
8 TO 40 VOLTS	50 μ A
UNKNOWN	50 μ A

GO

Figure 29-8 (Sheet 2 of 13)

GO

● Set function/range switch to setting you picked

NOTE

When you need to turn on power before measuring DC voltage, the fault isolation procedure gives the turn-on instructions

3

● Put multimeter leads across (in parallel with) circuit being measured

● Put test prod of black lead (-) on negative terminal of circuit being measured

● Put test prod of red lead (+) on positive terminal of circuit being measured

GO

FUNCTION/RANGE SWITCH SHOWN SET TO 50 μ A

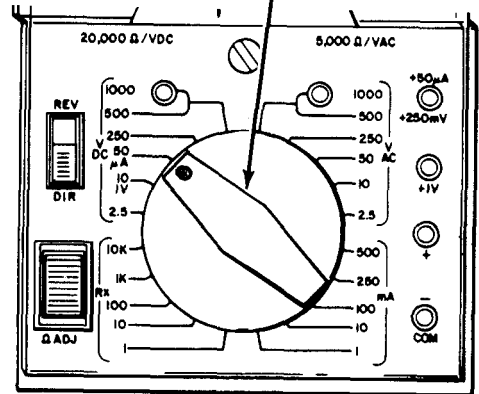

NOTE: MULTIMETER SHOWN MEASURING +24 VOLTS DC BATTERY VOLTAGE

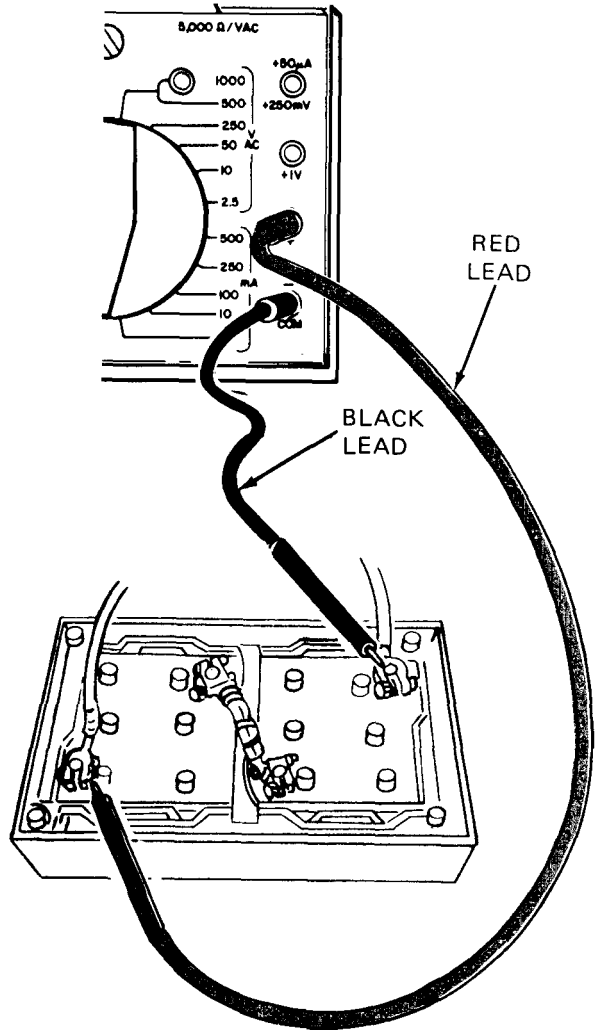
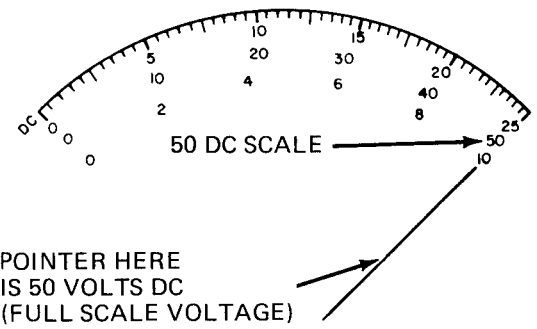

Figure 29-8 (Sheet 3 of 13)

GO

4

- If normal value of voltage being measured is 8 to 40 volts or unknown, read multimeter as follows
 - Use 50 DC scale. Full scale voltage is 50 volts DC



- Read each numbered line as shown

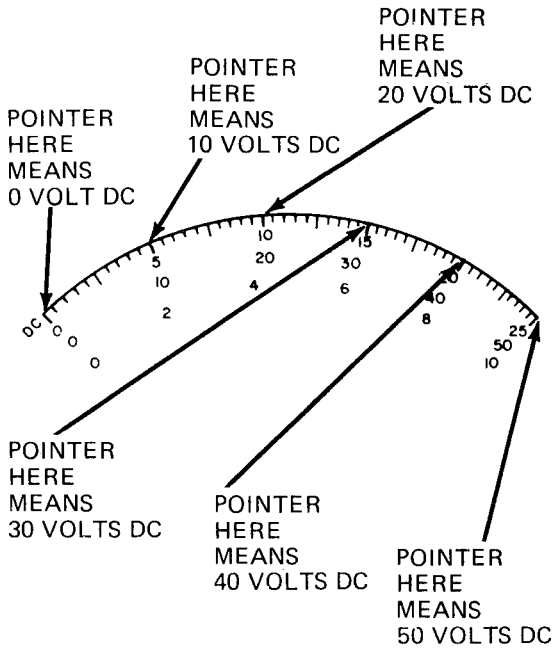

GO

Figure 29-8 (Sheet 4 of 13)

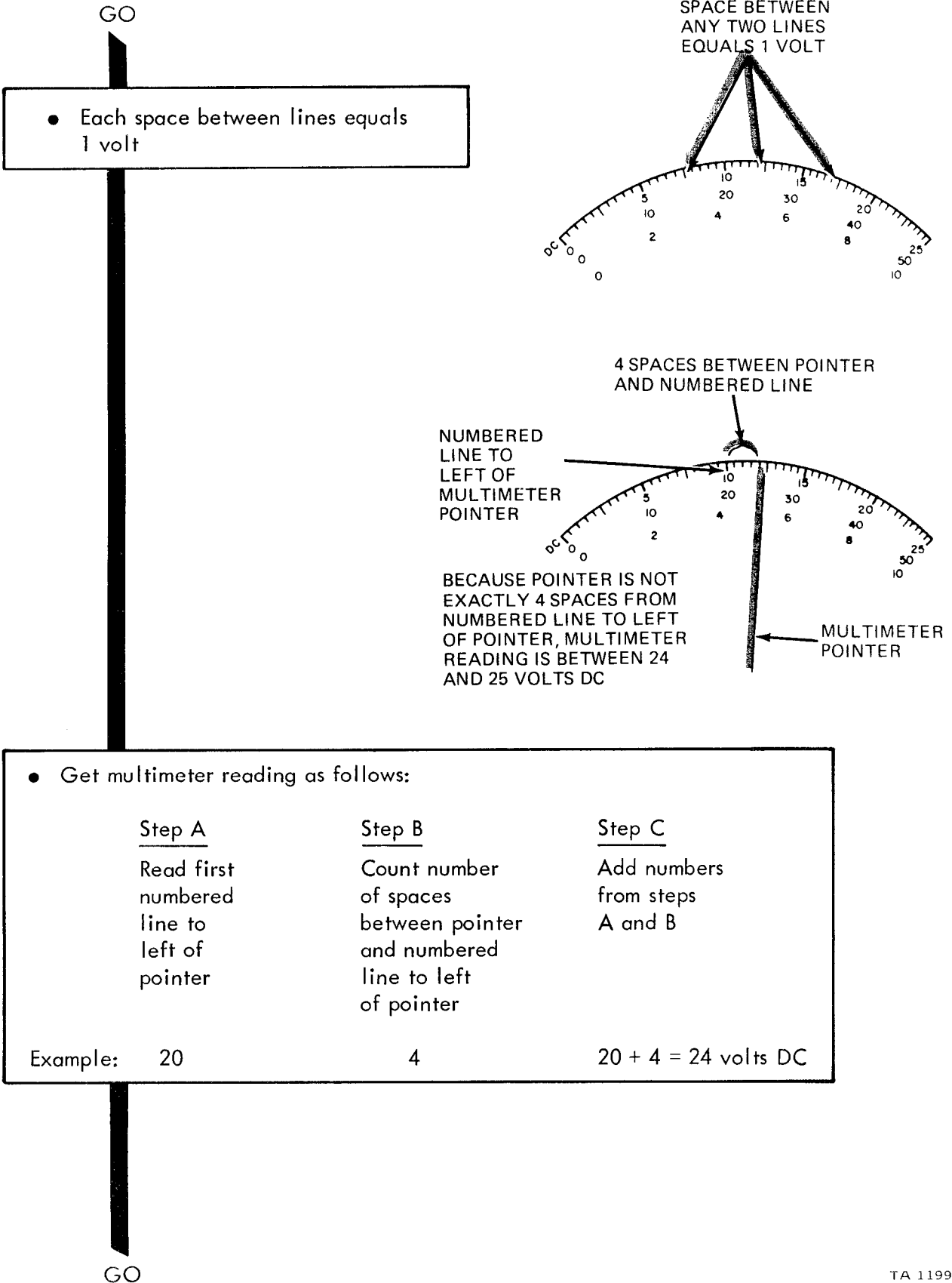

Figure 29-8 (Sheet 5 of 13)

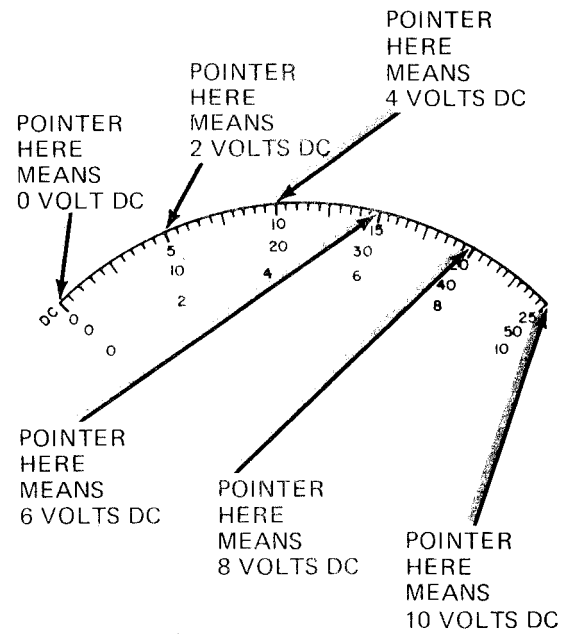
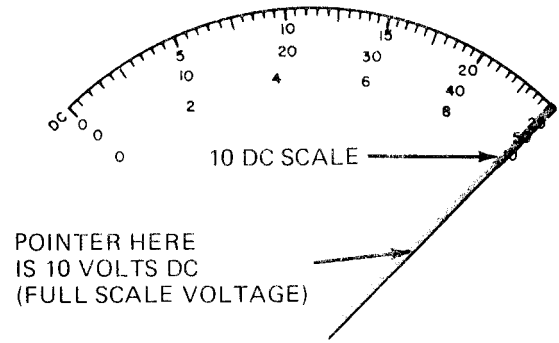
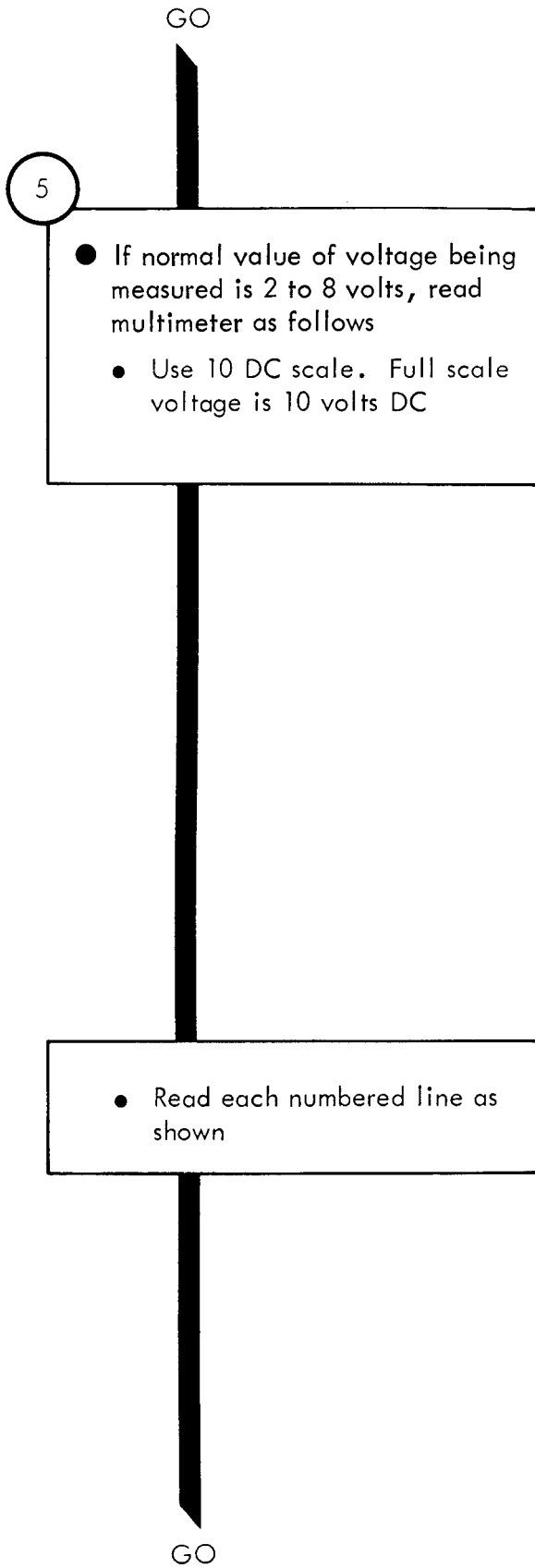
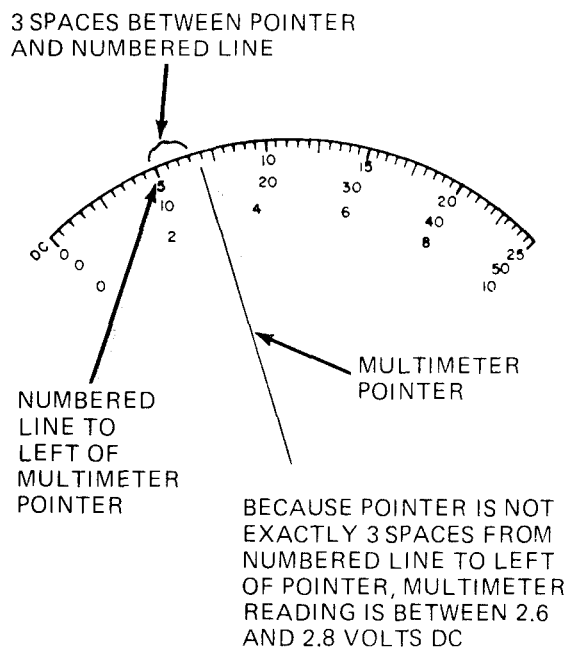
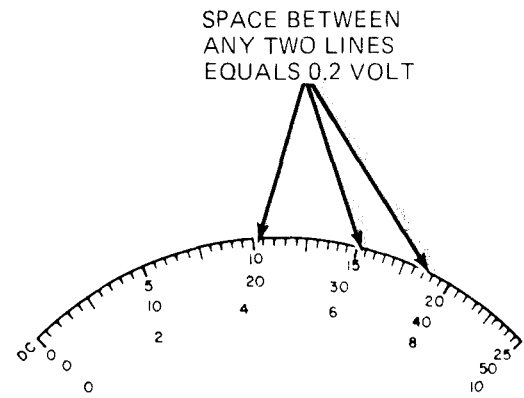

Figure 29-8 (Sheet 6 of 13)

TA 119955

GO

- Each space between lines equals 0.2 volt



- Get multimeter reading as follows:

Step A	Step B	Step C	Step D
Read first numbered line to left of pointer	Count number of spaces between pointer and first numbered line to left of pointer	Multiply number from step B by 0.2	Add numbers from steps A and C
Example: 2	3	$3 \times 0.2 = 0.6$	$2 + 0.6 = 2.6$ volts DC

GO

Figure 29-8 (Sheet 7 of 13)

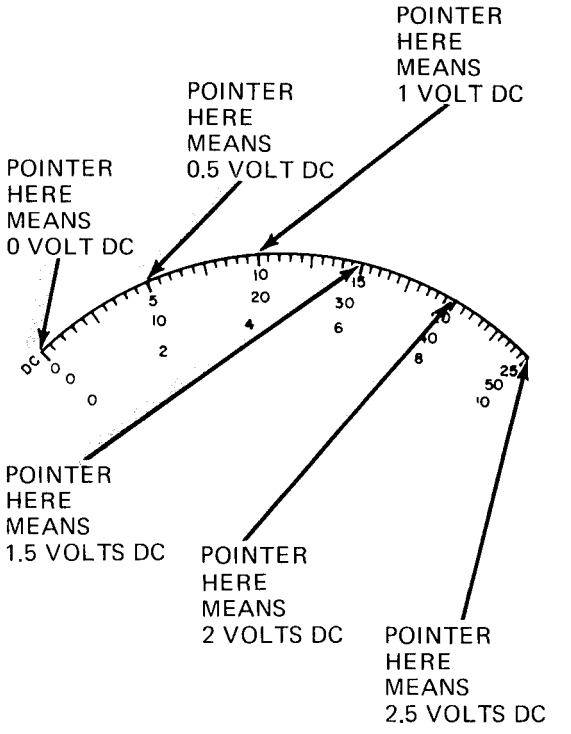
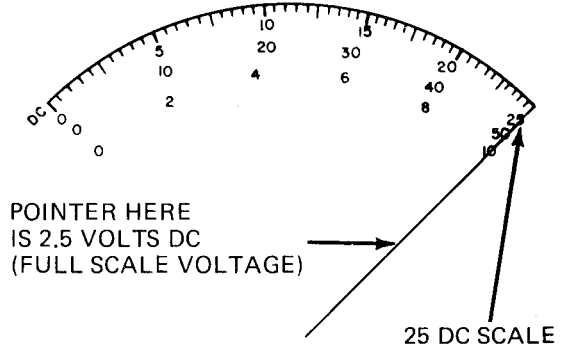
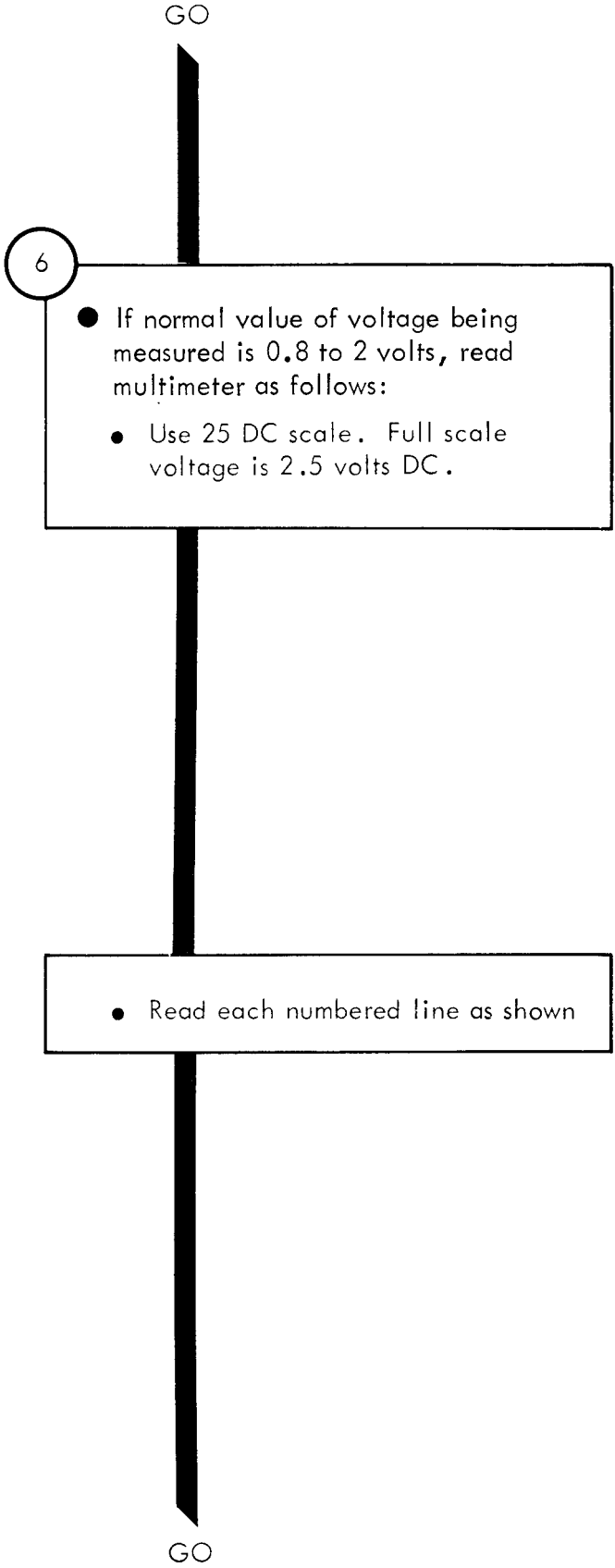
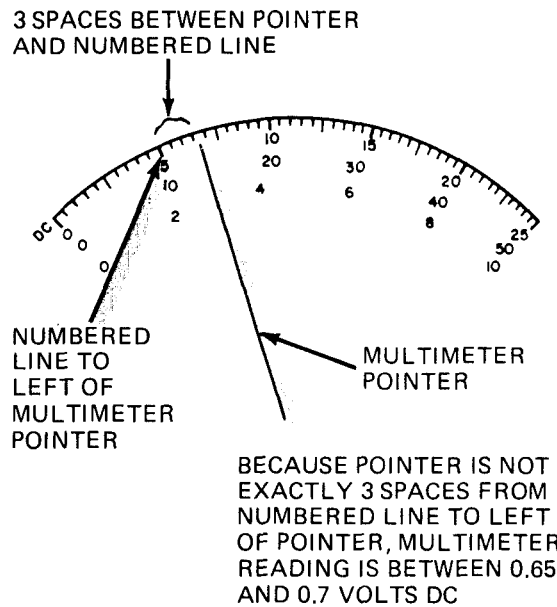
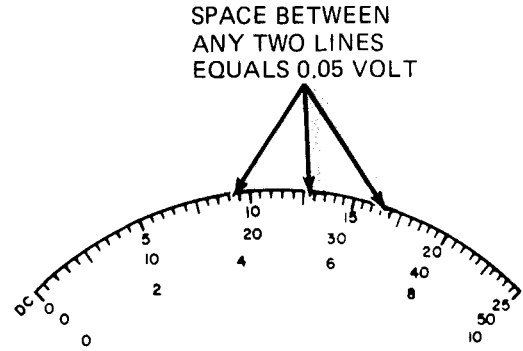

Figure 29-8 (Sheet 8 of 13)

GO

- Each space between lines equals 0.05 volt



<u>Step A</u>	<u>Step B</u>	<u>Step C</u>	<u>Step D</u>
Read first numbered line to left of pointer. Divide number by 10	Count number of spaces between pointer and first numbered line to left of pointer	Multiply number from step B by 0.05	Add numbers from steps A and C
Example: 0.5	3	$3 \times 0.05 = 0.15$	$0.5 + 0.15 = 0.65$ volt DC

GO

Figure 29-8 (Sheet 9 of 13)

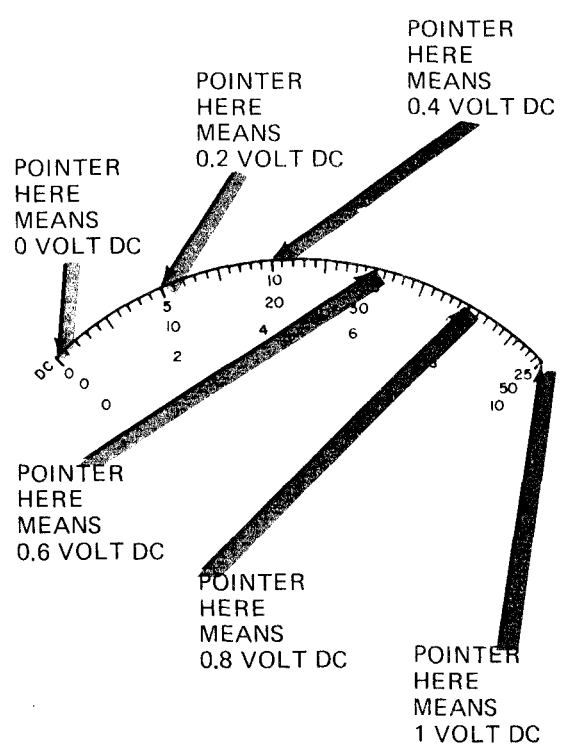
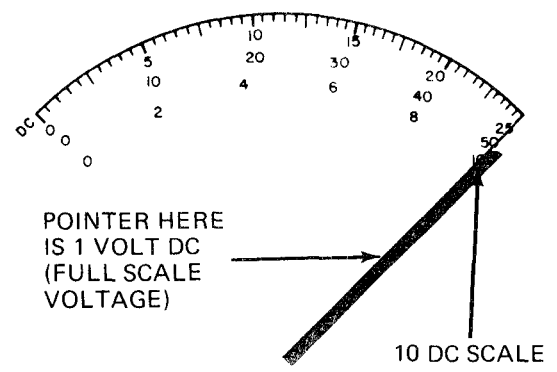
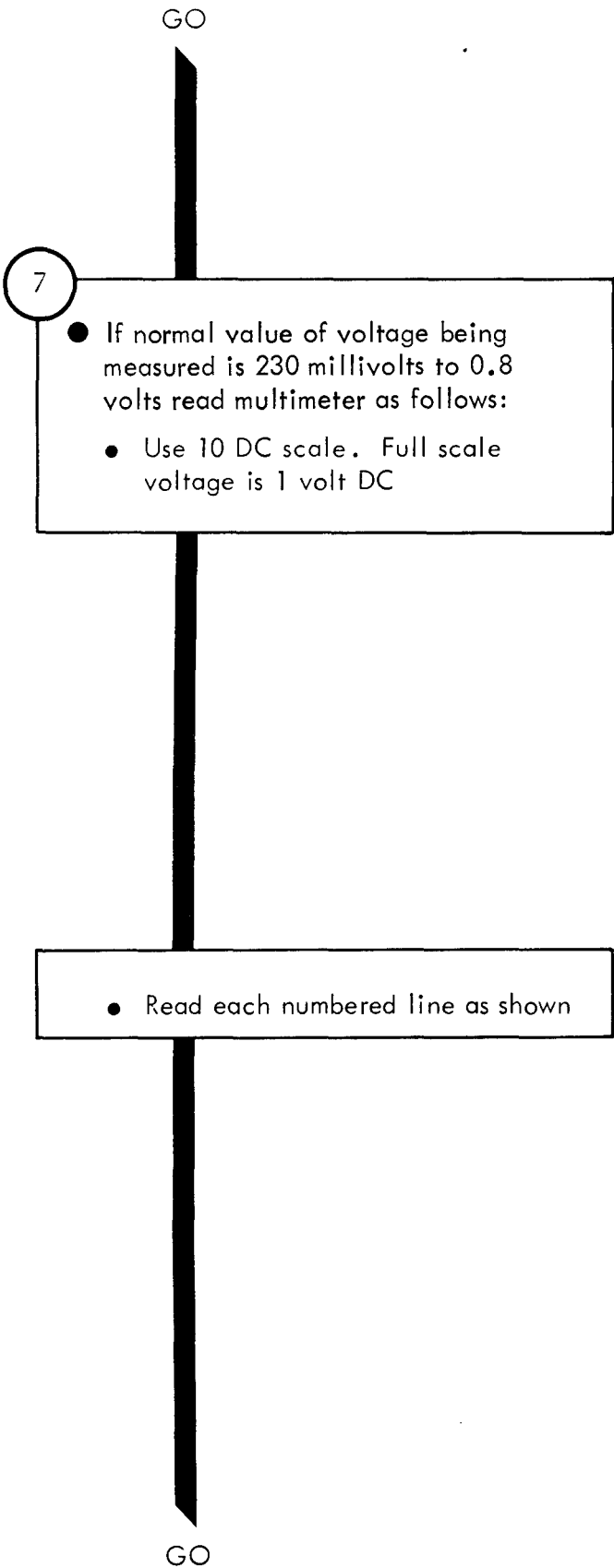

TA 119959

Figure 29-8 (Sheet 10 of 13)

GO

- Each space between lines equals 0.02 volt

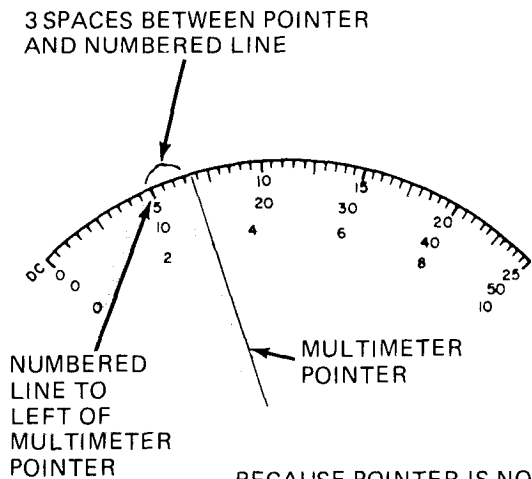
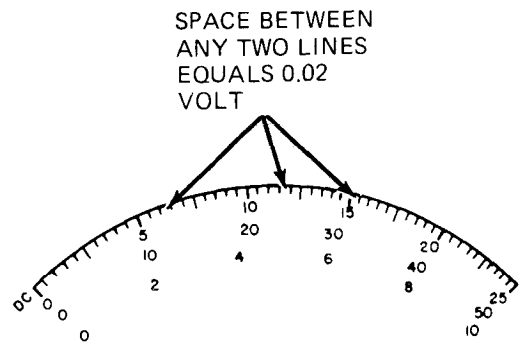

BECAUSE POINTER IS NOT EXACTLY 3 SPACES FROM NUMBERED LINE TO LEFT OF POINTER, MULTIMETER READING IS BETWEEN 0.26 AND 0.28 VOLTS DC

- Get multimeter reading as follows:

<u>Step A</u>	<u>Step B</u>	<u>Step C</u>	<u>Step D</u>
Read first numbered line to left of pointer. Divide number by 10	Count number of spaces between pointer and first numbered line to left of pointer	Multiply number from step B by 0.02	Add numbers from steps A and C
Example: 0.2	3	$3 \times 0.02 = 0.06$	$0.2 + 0.06 = 0.26$ volt DC

GO

Figure 29-8 (Sheet 11 of 13)

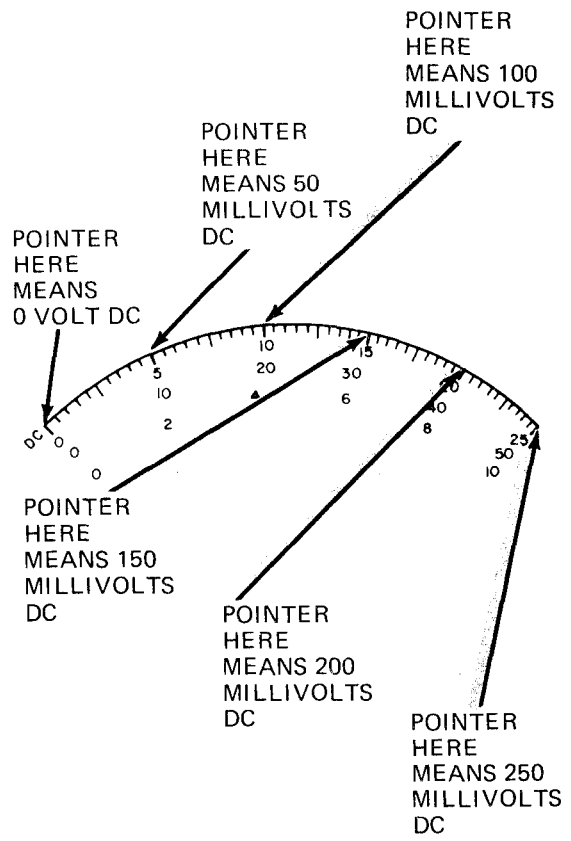
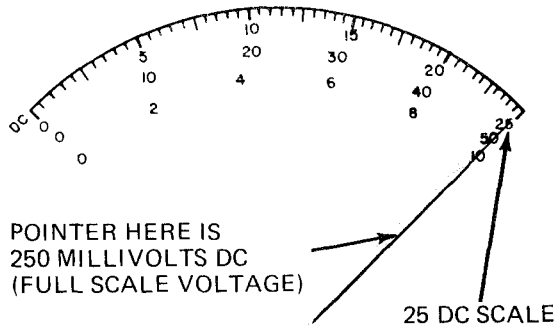
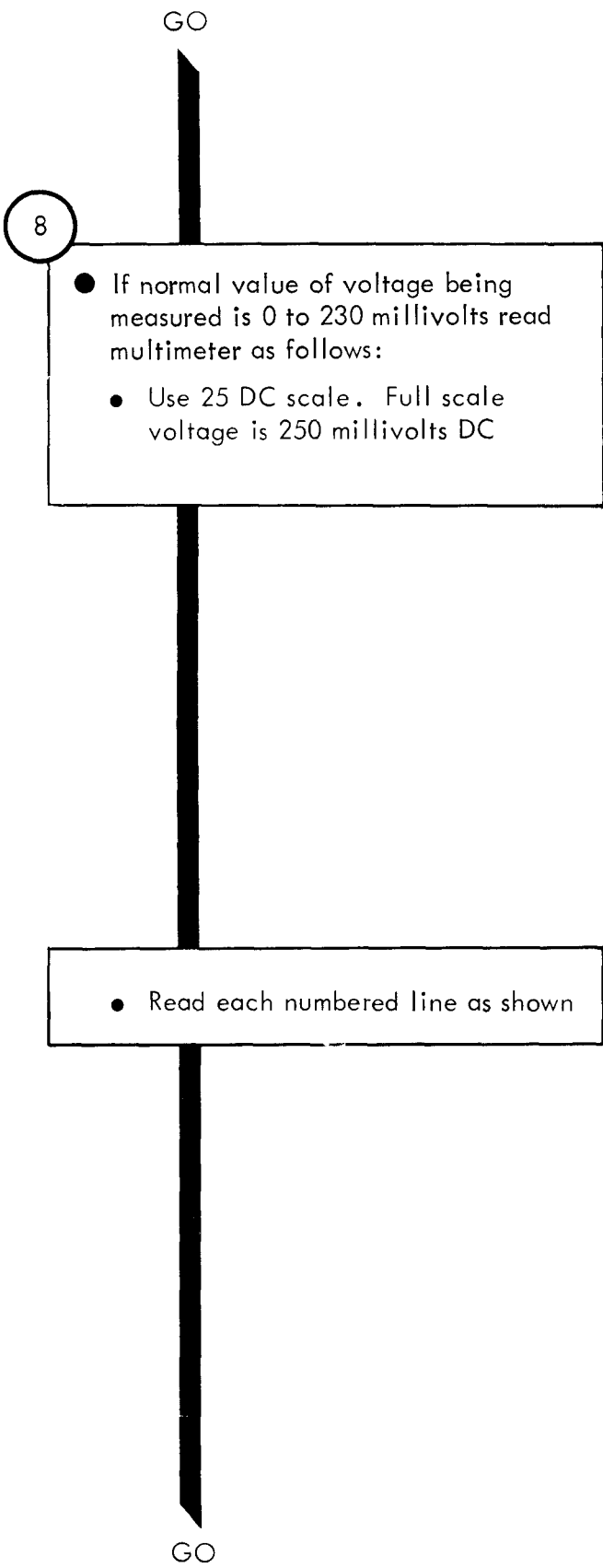
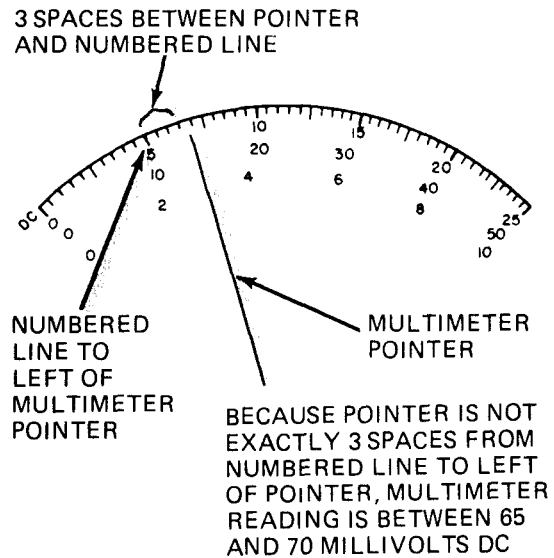
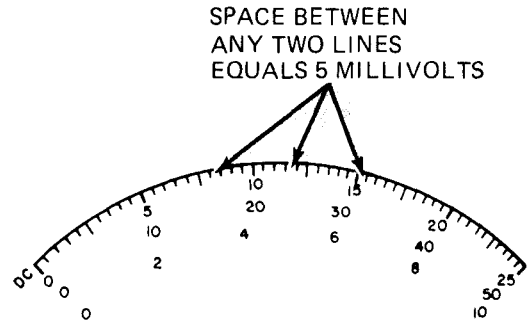

Figure 29-8 (Sheet 12 of 13)

TA 119961

GO

● Each space between lines equals 5 millivolts



● Get multimeter reading as follows:

	<u>Step A</u>	<u>Step B</u>	<u>Step C</u>	<u>Step D</u>
	Read first numbered line to left of pointer	Count number of spaces between pointer and first numbered line to left of pointer	Multiply number from step B by 5	Add numbers from steps A and C
Example:	50	3	$3 \times 5 = 15$	$50 + 15 = 65$ millivolts DC

9

● Make circuit normal again.

● Take both test prods off measured circuit.

Figure 29-8 (Sheet 13 of 13)

2

AC VOLTAGE TEST - To measure van input and operating voltages

1

- Set Up Multimeter As Follows:
 - Note: The truck AC voltages measured are 208 and 120 volts. Therefore, only the 250 VAC function/range switch position is used
 - Set function/range switch to 250 VAC
 - Set REV DIR switch to DIR
 - Note: The Ω ADJ knob is not used for DC voltage tests
 - Put jack plug of black test lead into COM - jack receptacle
 - Put jack plug of red test lead into + jack receptacle

NOTE

When you need to turn on power before measuring AC voltage, the fault isolation procedure gives the turn-on instructions

GO

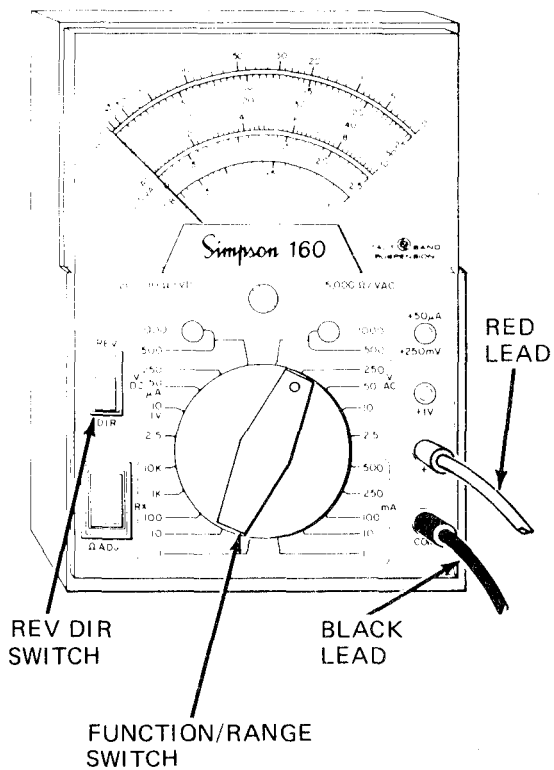

TA 119963

Figure 29-9 (Sheet 1 of 4)

GO

2

- Put multimeter lead across (in parallel with) circuit being measured

Note: In AC voltage measurement you can hook up the test lead connections to the circuit either way. You will still get correct multimeter readings and no damage will be done to the multimeter. But, when one side of the circuit is electrical ground, it is a good idea to put the black lead on electrical ground.

- Put test prod of black lead on ground side or one side of the circuit being tested. Put test prod of red lead on other side of circuit being measured

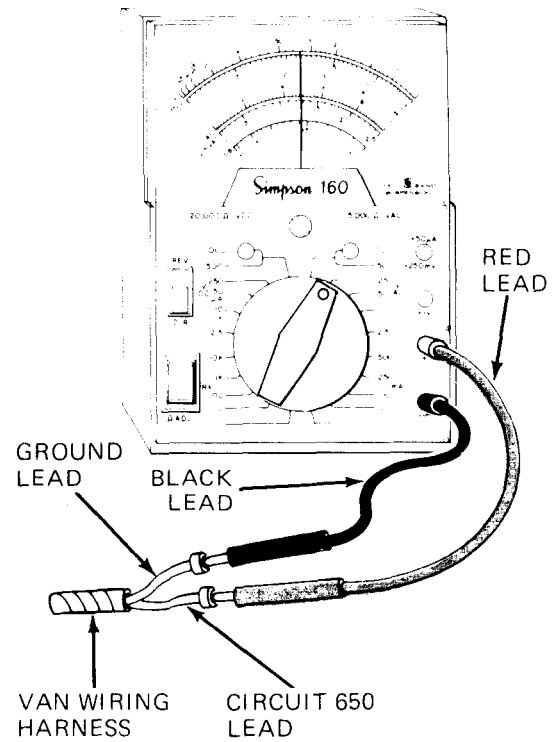

NOTE: MULTIMETER SHOWN MEASURING 120 VOLTS AC VAN CEILING LIGHT VOLTAGE.

3

- Read multimeter
- Use 25 AC scale. Full scale voltage is 250 volts AC

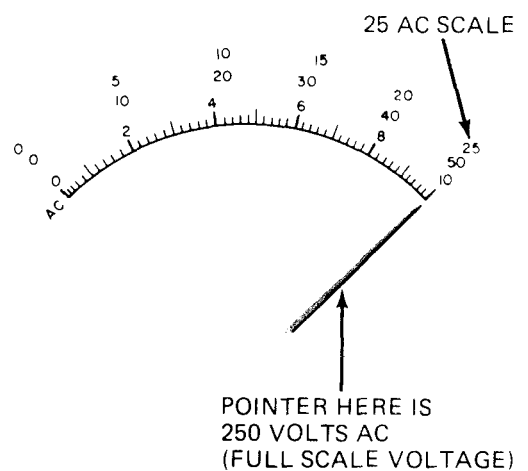

GO

Figure 29-9 (Sheet 2 of 4)

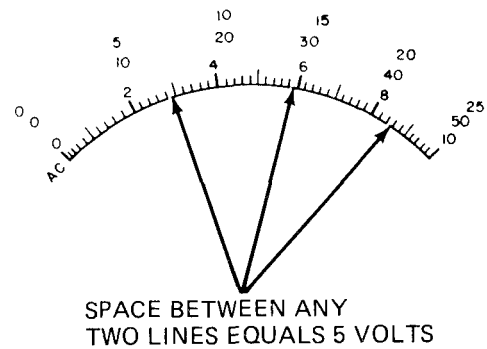
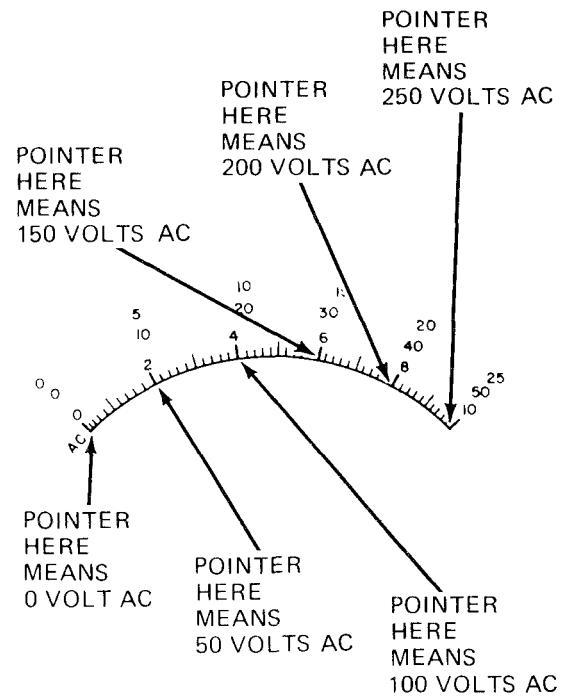
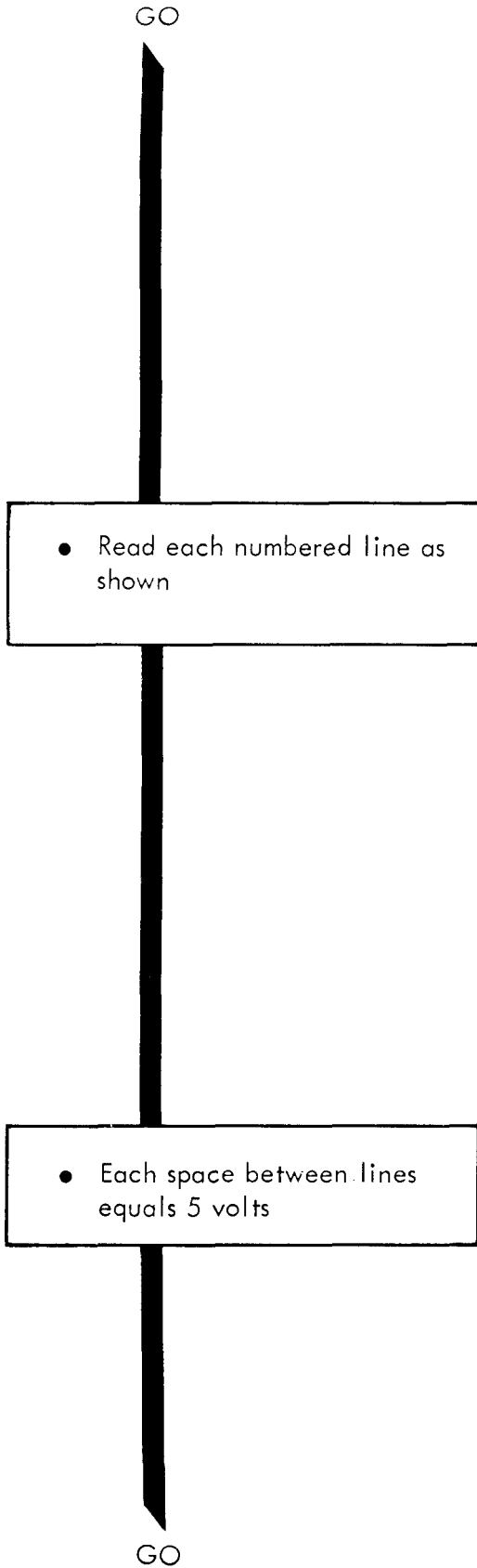

TA 119965

Figure 29-9 (Sheet 3 of 4)

GO

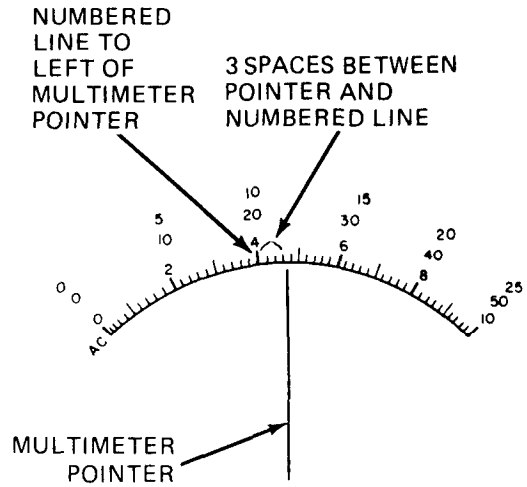

BECAUSE POINTER IS NOT EXACTLY 3 SPACES FROM NUMBERED LINE TO LEFT OF POINTER, MULTIMETER READING IS BETWEEN 115 AND 120 VOLTS AC

- Get multimeter reading as follows:

<u>Step A</u>	<u>Step B</u>	<u>Step C</u>	<u>Step D</u>
Read first numbered line to left of pointer. Multiply number by 10.	Count number of spaces between pointer and first numbered line to left of pointer.	Multiply number from step B by 5.	Add numbers from steps A and C.
Example: 100	3	$3 \times 5 = 15$	$100 + 15 = 115$ volts AC

4

- Make circuit normal again
- Take both test prods off measured circuit

Figure 29-9 (Sheet 4 of 4)

3 Test

RESISTANCE TEST - To measure resistance of temperature sending unit, and blower motor resistor

1

- Set up multimeter
 - Set REV DIR switch to REV
 - Set function/range switch to 10K
 - Put jack plug of black test lead into COM - jack
 - Put jack plug of red test lead into + jack

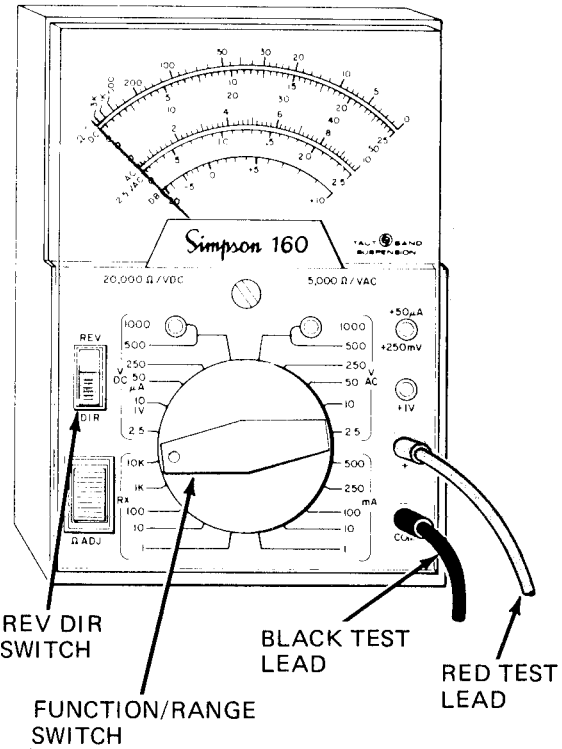

NOTE

Detailed steps for making the truck parts ready for resistance test are in the fault isolation procedures. The steps given here are typical

2

- Make tested part ready for resistance test

GO

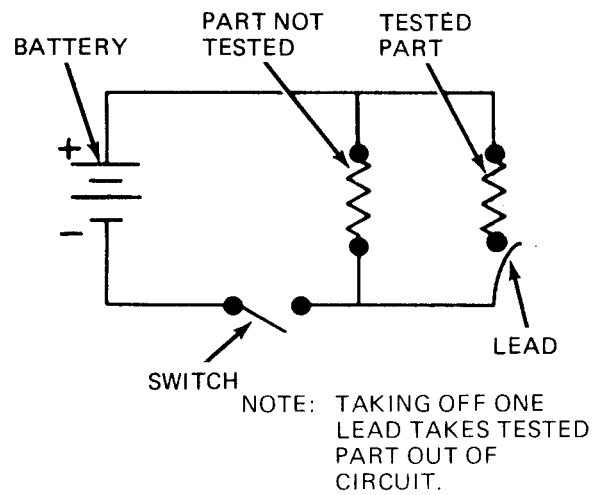
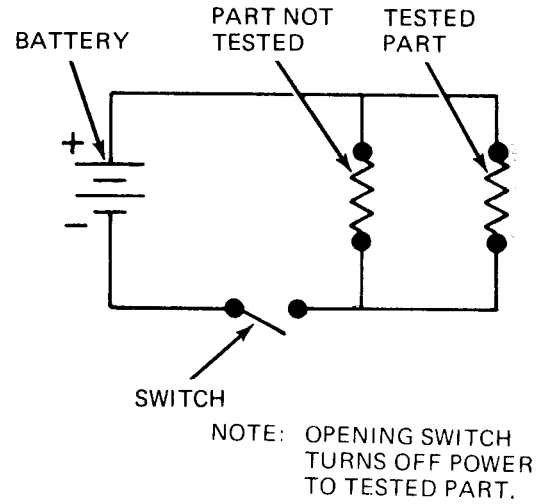
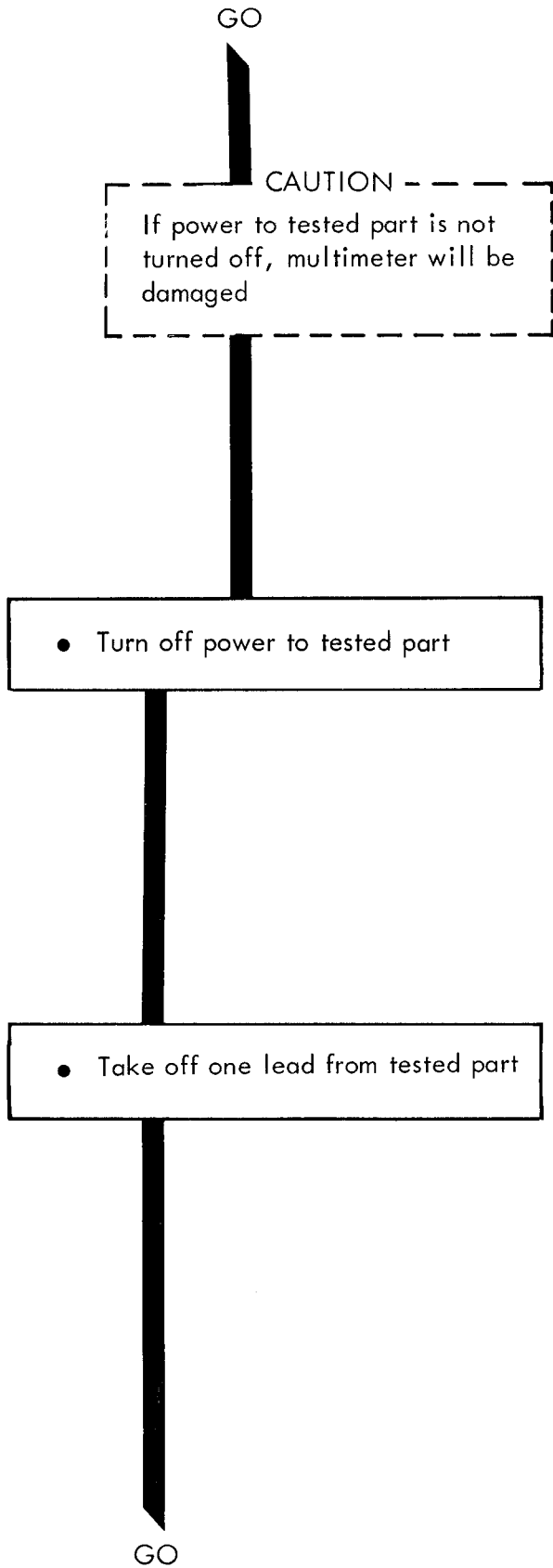
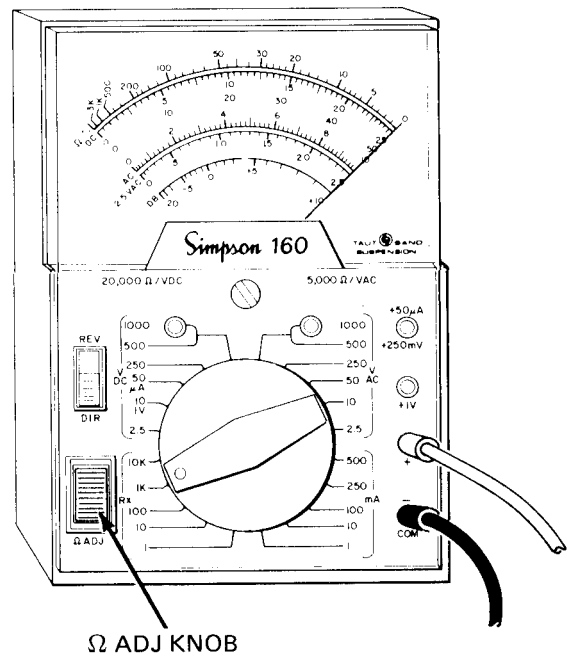
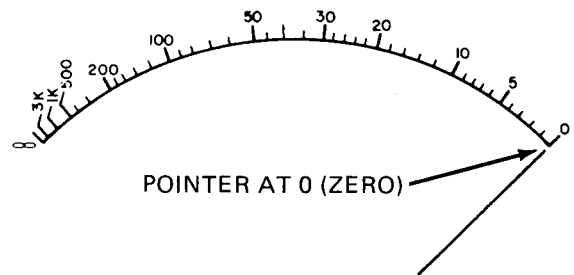
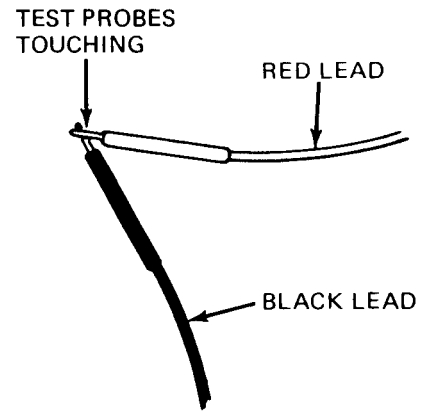
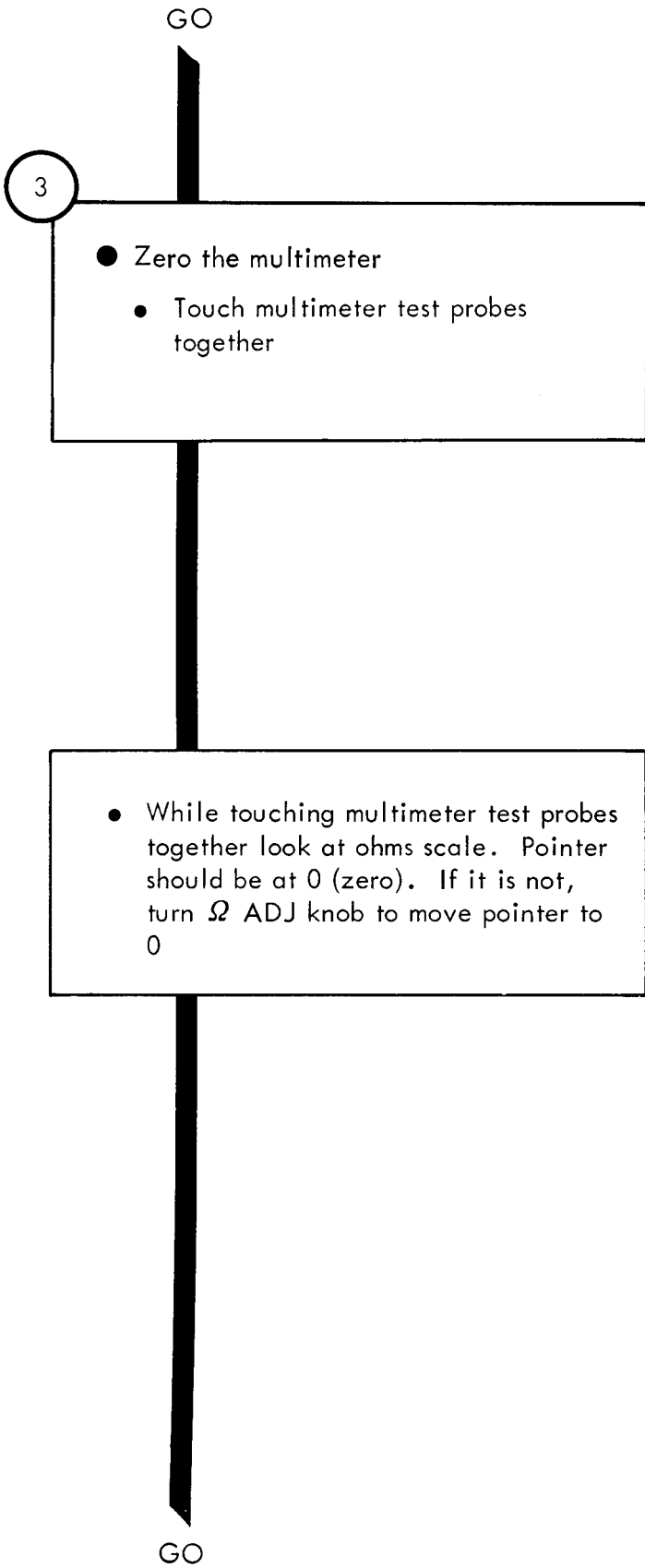

Figure 29-10 (Sheet 2 of 10)



TA 119969

Figure 29-10 (Sheet 3 of 10)

GO

4

- Put multimeter leads across tested part
 - Put one test prod on one terminal of tested part
 - Put other test prod on other terminal of tested part

NOTE

Zero the multimeter each time you turn the function/range switch knob to another position. (See step 3)

GO.

NOTE: MULTIMETER SHOWN MEASURING RESISTANCE OF A COLD START RESISTOR.

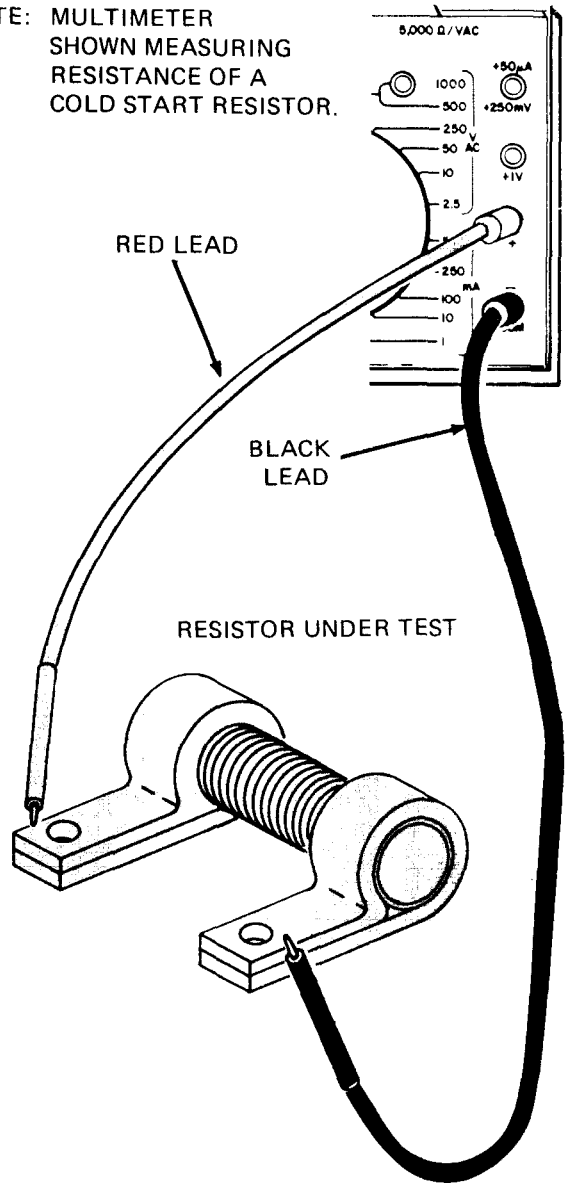
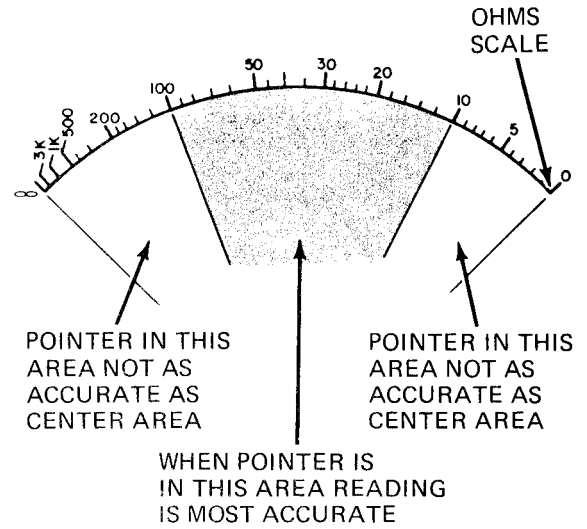

Figure 29-10 (Sheet 4 of 10)

GO



TS 260-20-325

5

- Get the most accurate multimeter reading as follows:
 - Note: The closer the multimeter pointer is to the center of the ohms scale, the more accurate the reading
 - Note position of pointer on ohms scale. Turn function/range knob to left while looking at pointer. Try to find function/range switch knob position that gives most centered pointer position

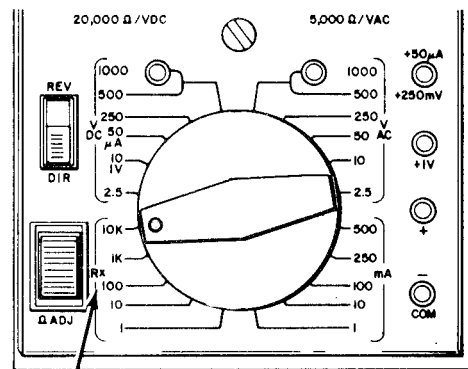

ONLY THESE SWITCH POSITIONS USED FOR RESISTANCE MEASUREMENTS

NOTE: MOVING FUNCTION/RANGE SWITCH KNOB TO LEFT MOVES POINTER TO LEFT

GO

TA 119971

Figure 29-10 (Sheet 5 of 10)

GO

● You may overshoot most centered pointer position. If you do, turn function/range switch knob to right to put pointer in most centered position

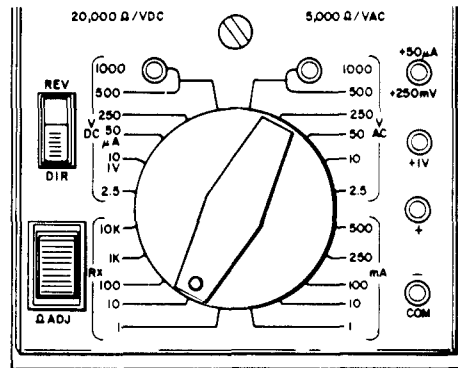

NOTE: MOVING FUNCTION/RANGE SWITCH KNOB TO RIGHT MOVES POINTER TO RIGHT

● Pointer will stay in right area if resistance is less than 10 ohms. Pointer will stay in left area if resistance is more than 1,000,000 ohms

● Leave function/range switch in position that puts pointer in most centered position

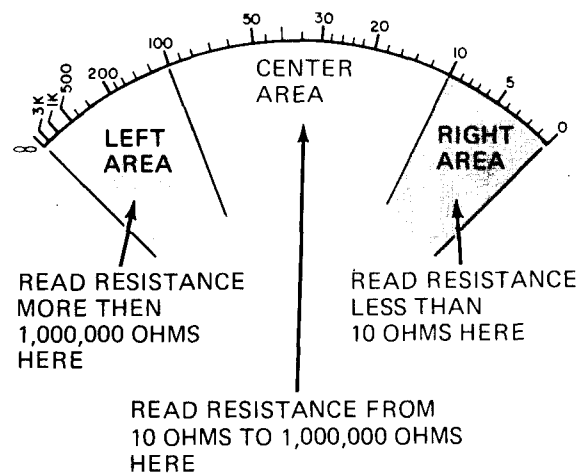

GO

Figure 29-10 (Sheet 6 of 10)

GO

6

- If pointer falls exactly on a numbered line read multimeter as follows:
 - a. Look at ohms scale and see which numbered line pointer is on: 50

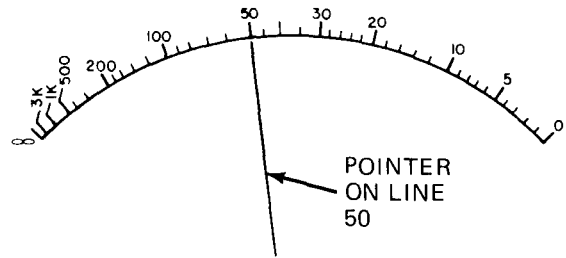

TS 260-20-332

- b. See what function/range switch position number is: 10
- c. Multiply number from step a by number from step b to get multimeter reading: $50 \times 10 = 500$ ohms

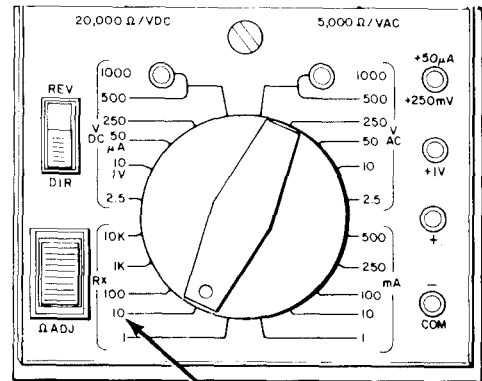

FUNCTION/RANGE SWITCH POSITION NUMBER IS 10

GO

Figure 29-10 (Sheet 7 of 10)

TA 119973

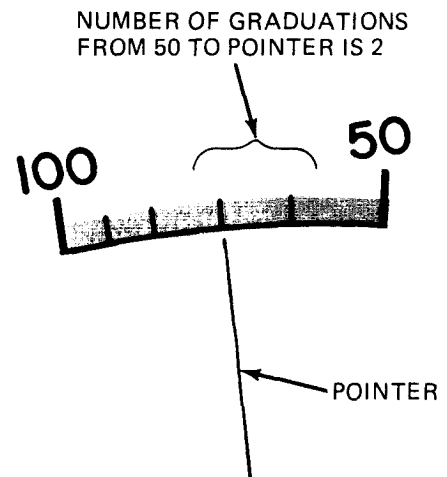
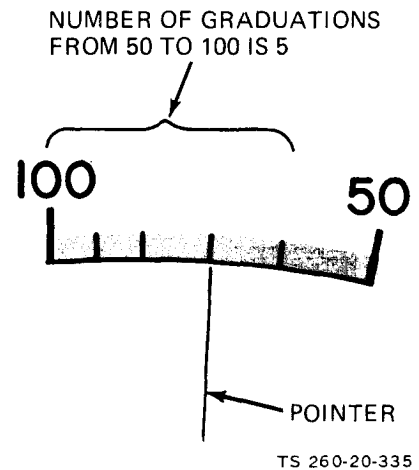
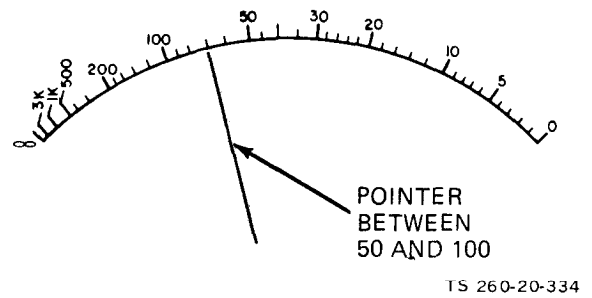
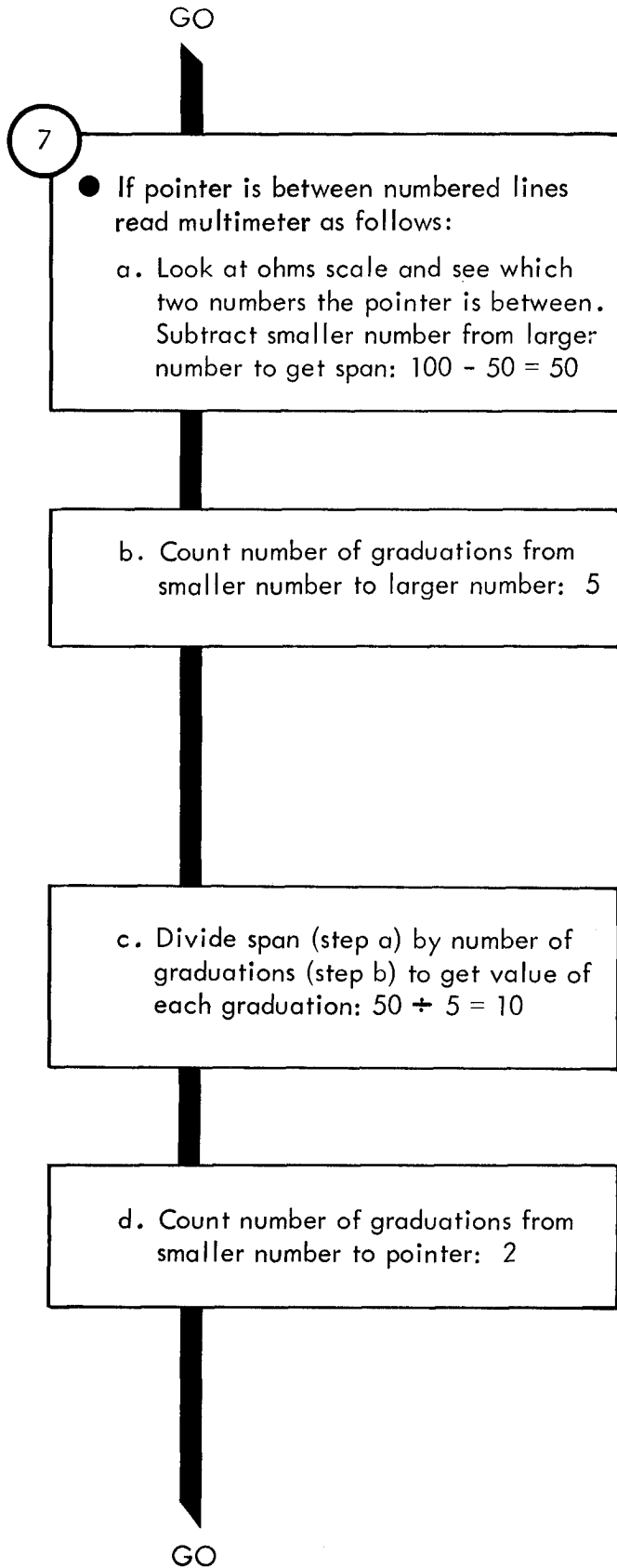

Figure 29-10 (Sheet 8 of 10)

GO

e. Multiply number from step 7d by value from step 7c to get total value of graduations:

$$2 \times 10 = 20$$

f. Add total value of graduations (step e) to smaller number to get scale reading:

$$20 + 50 = 70$$

g. Multiply scale reading (step f) by function/range switch position number to get multimeter reading:

$$70 \times 10 = 700 \text{ ohms}$$

GO

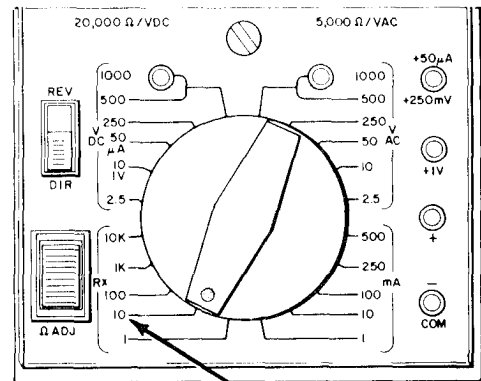
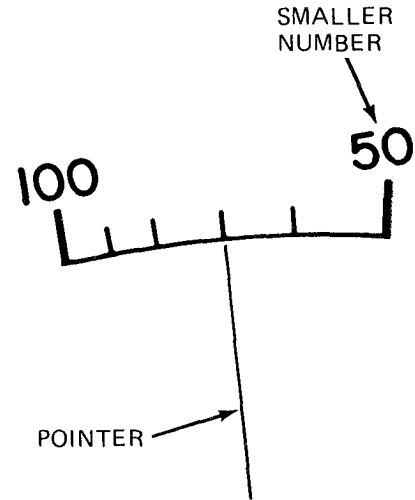

FUNCTION/RANGE SWITCH POSITION NUMBER IS 10

GO

8

- Put tested part back in circuit
 - Take off both test prods from across tested part
 - Put lead back on tested part

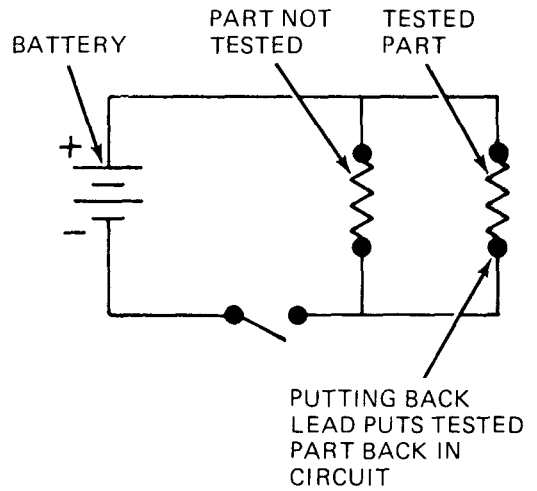

Figure 29-10 (Sheet 10 of 10)

4

CONTINUITY TEST - To check for breaks in a circuit, such as switch, lamp, or electrical cable circuits

1

- Set up multimeter
 - Set REV DIR switch to DIR
 - Set function/range switch to RX1
 - Put jack plug of black (-) test lead into COM - jack
 - Put jack plug of red (+) test lead into + jack

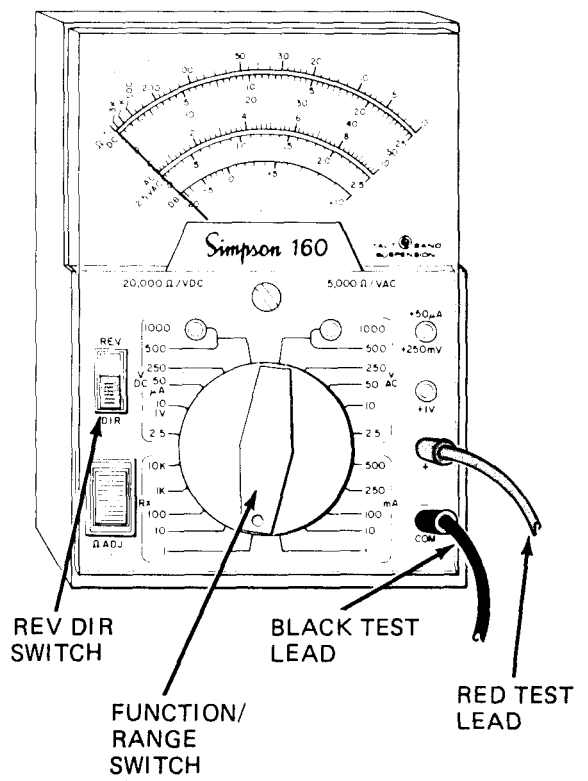

TA 119976

Figure 29-11 (Sheet 1 of 6)

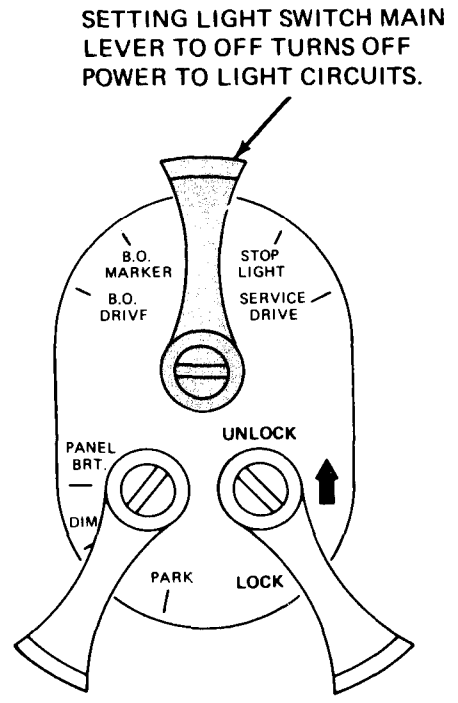
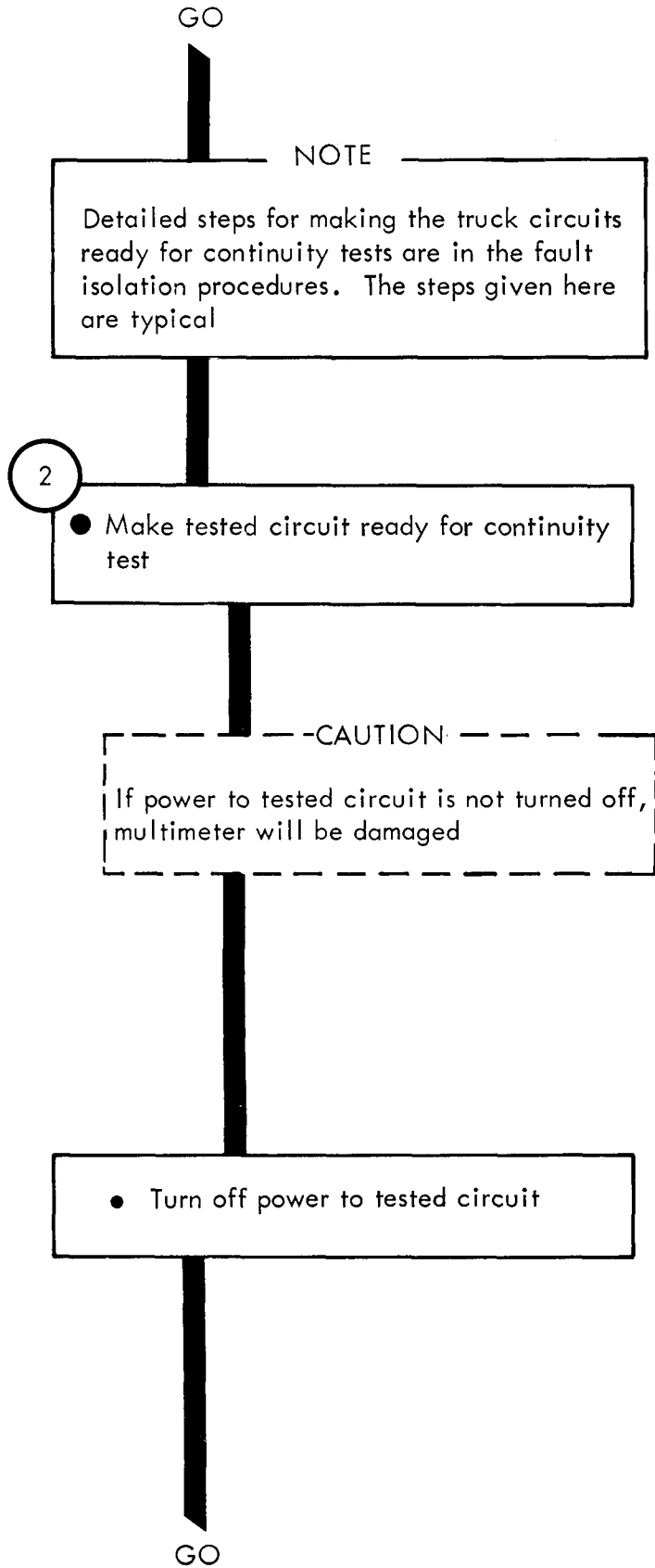
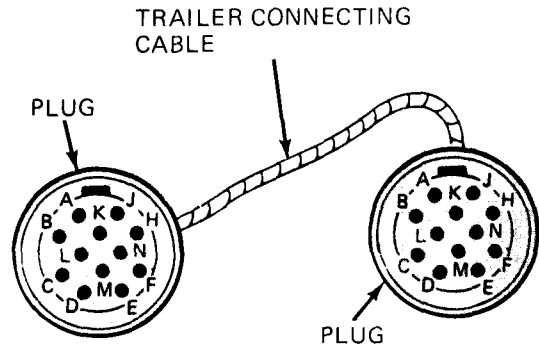

Figure 29-11 (Sheet 2 of 6)

TA 119977

GO

- Take plug on each end of trailer connecting cable off mating receptacle



TAKING CABLE PLUGS OFF MATING RECEPTACLES LETS YOU TEST CONTINUITY OF CABLE WIRES

3

- Zero the multimeter
- Touch multimeter test probes together

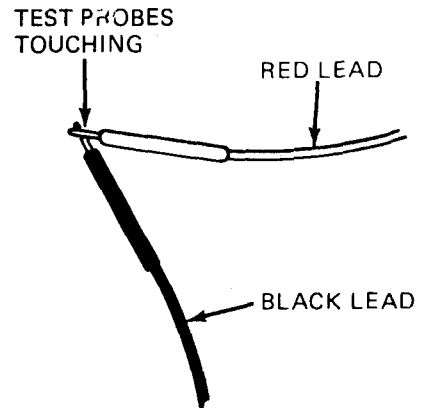

GO

Figure 29-11 (Sheet 3 of 6)

GO

- While touching multimeter test probes together look at ohms scale. Pointer should be at 0 (zero). If it is not, turn Ω ADJ knob to move pointer to 0

GO

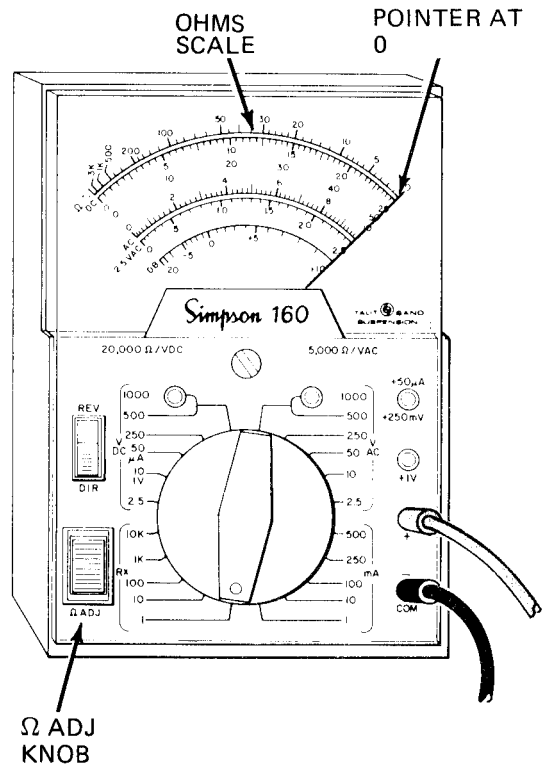

TA 119979

Figure 29-11 (Sheet 4 of 6)

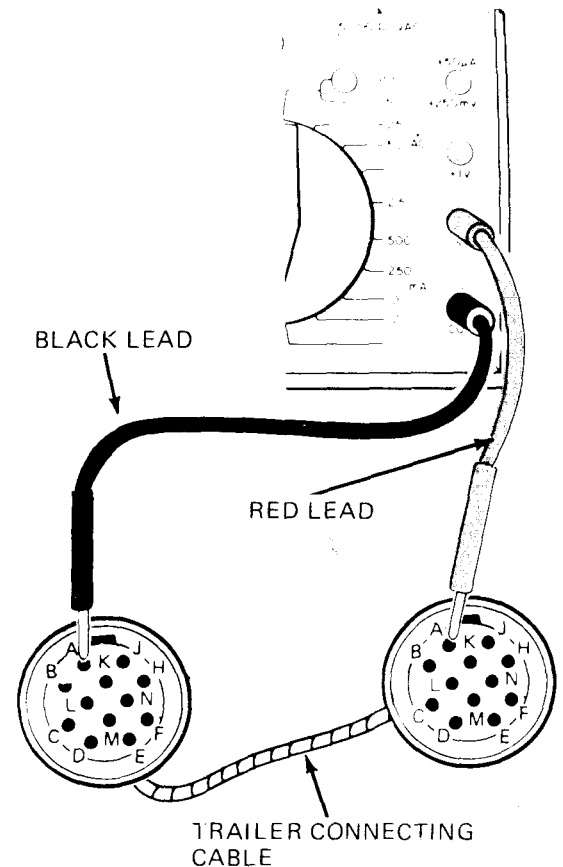
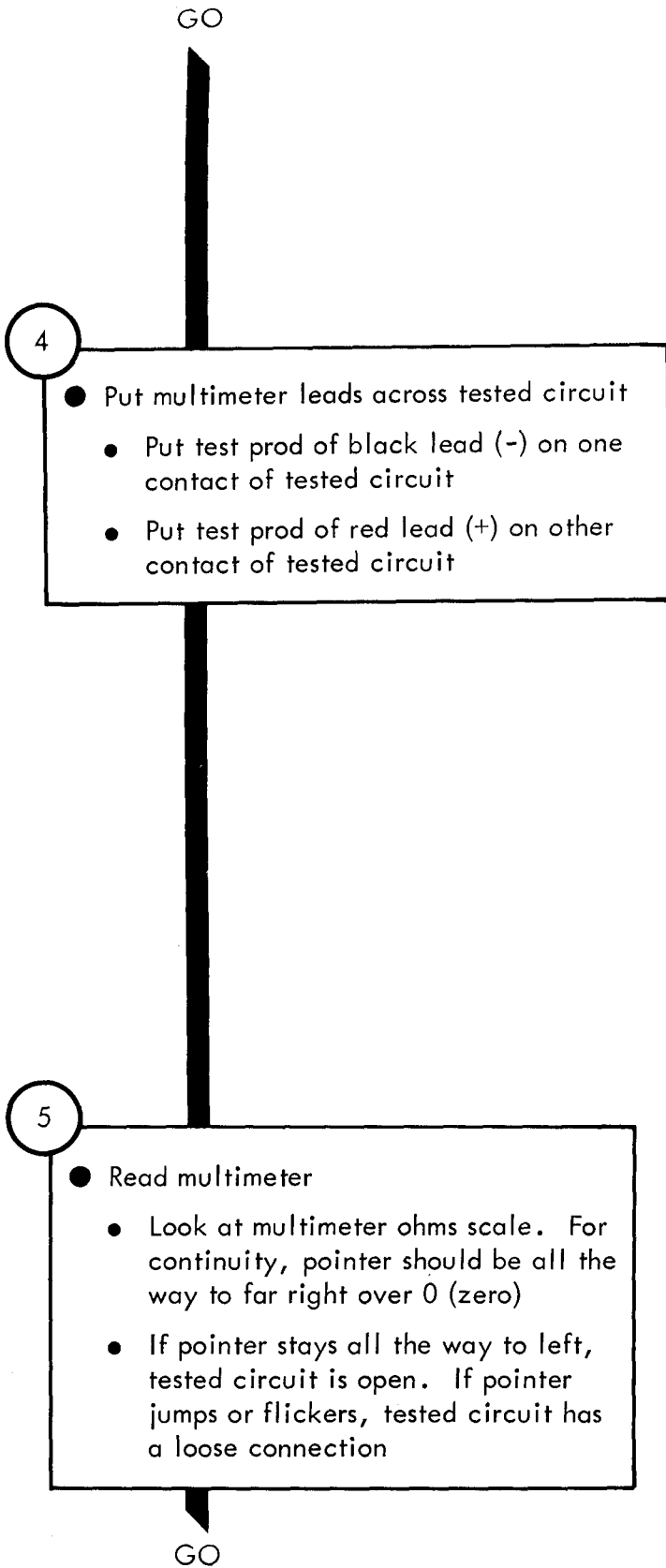

NOTE: MULTIMETER SHOWN CHECKING CONTINUITY OF TRAILER CONNECTING CABLE WIRE ATTACHED TO CONTACT A.

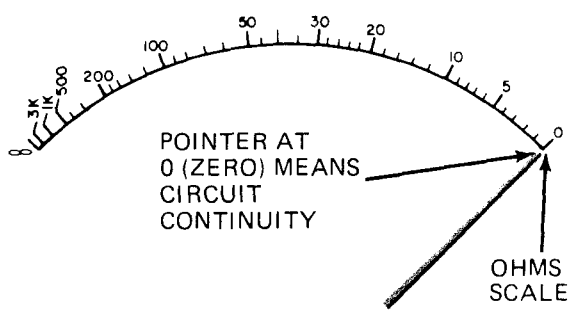

Figure 29-11 (Sheet 5 of 6)

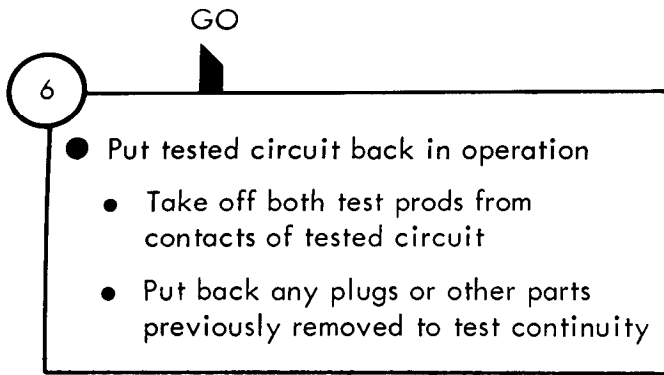
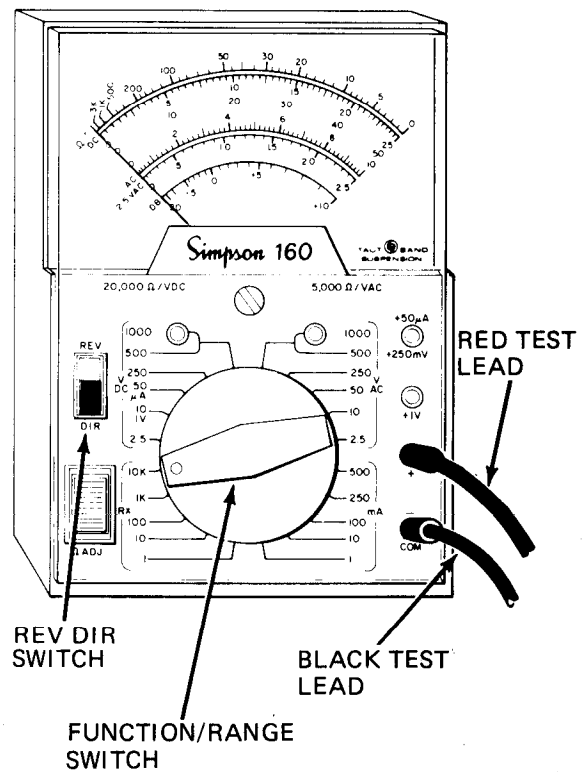
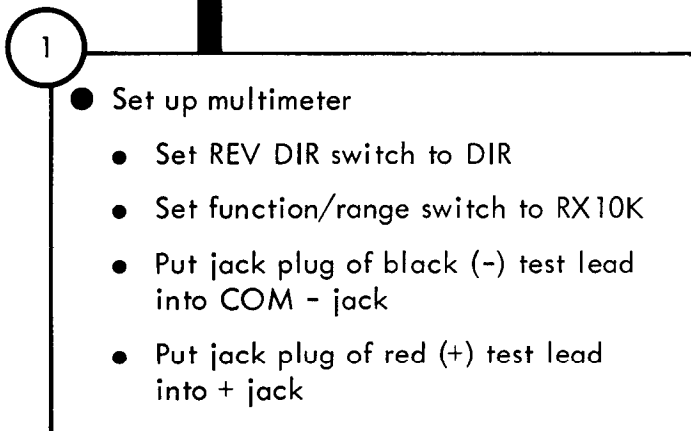
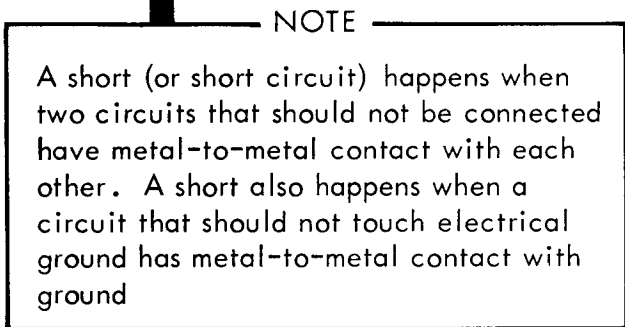
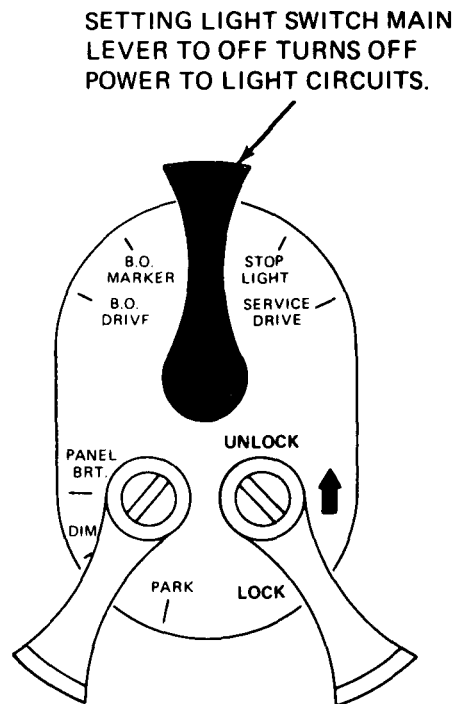
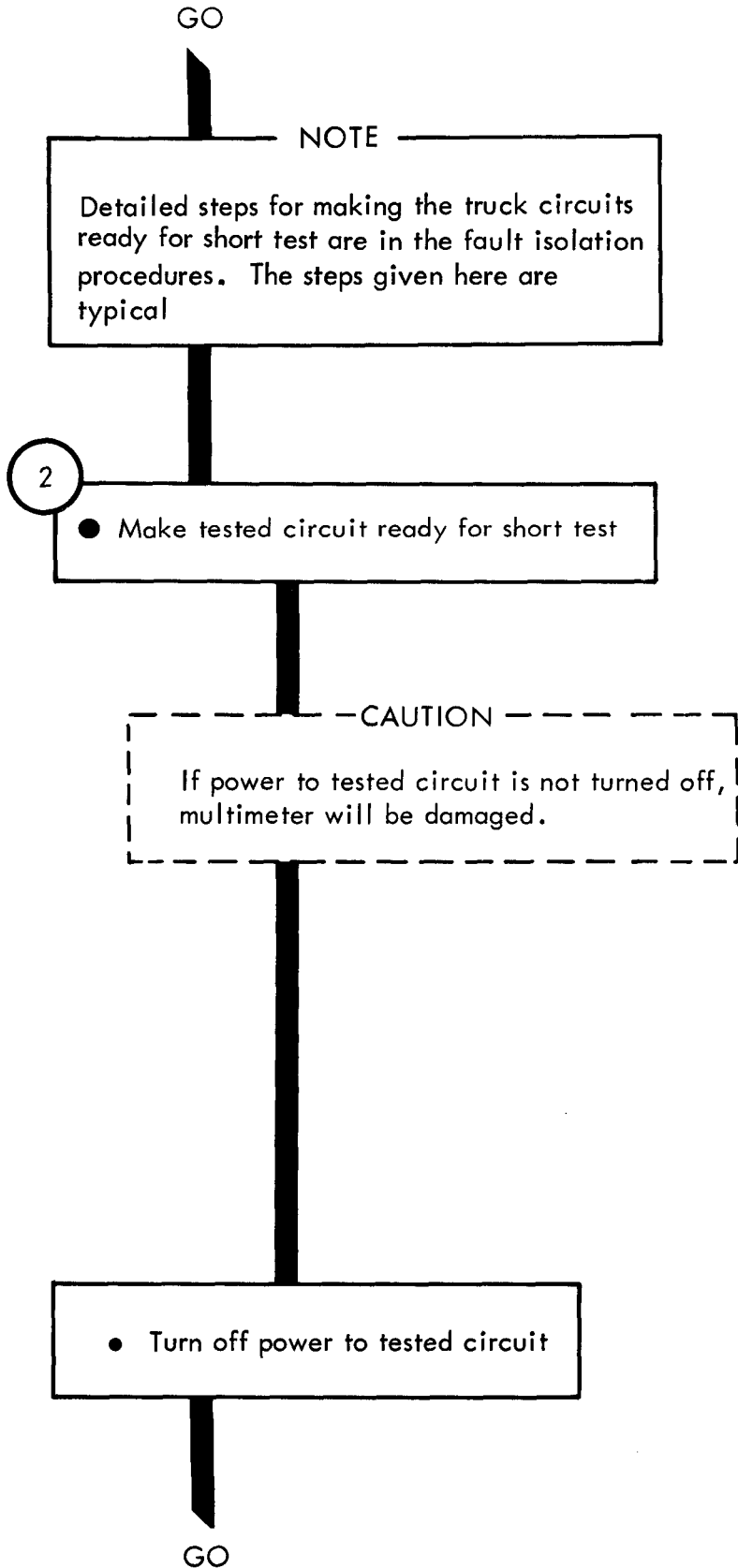

Figure 29-11 (Sheet 6 of 6)



GO

Figure 29-12 (Sheet 1 of 7)



TA 119982

Figure 29-12 (Sheet 2 of 7)

GO

- Take plug on each end of trailer connecting cable off mating receptacle

TAKING CABLE PLUGS OFF MATING RECEPTACLES LETS YOU TEST CABLE WIRES FOR SHORTS

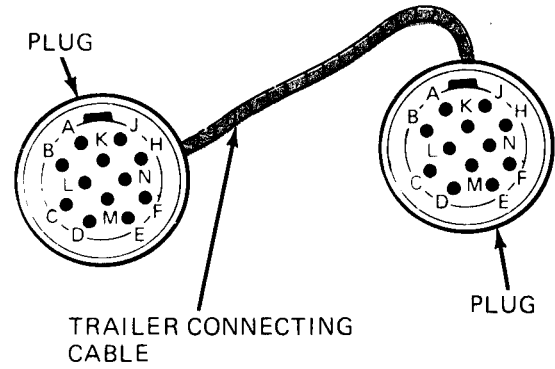

3

- Zero the multimeter
- Touch multimeter test probes together

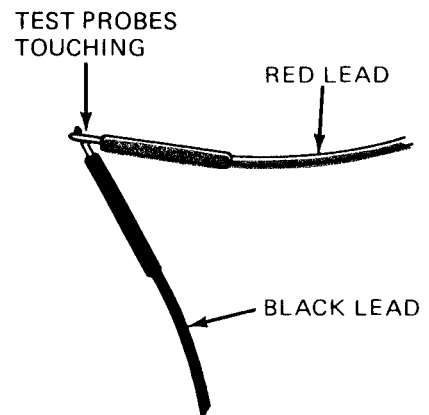

GO

Figure 29-12 (Sheet 3 of 7)

GO

- While touching multimeter test probes together look at ohms scale. Pointer should be at 0 (zero). If it is not, turn Ω ADJ knob to move pointer to 0

GO

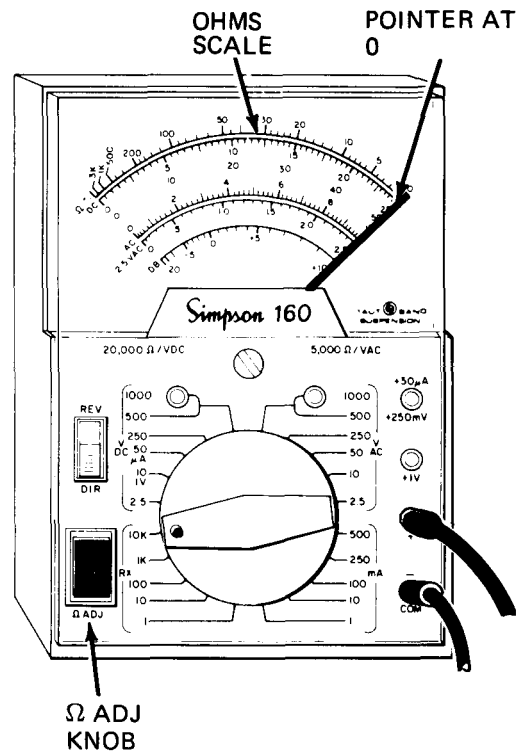
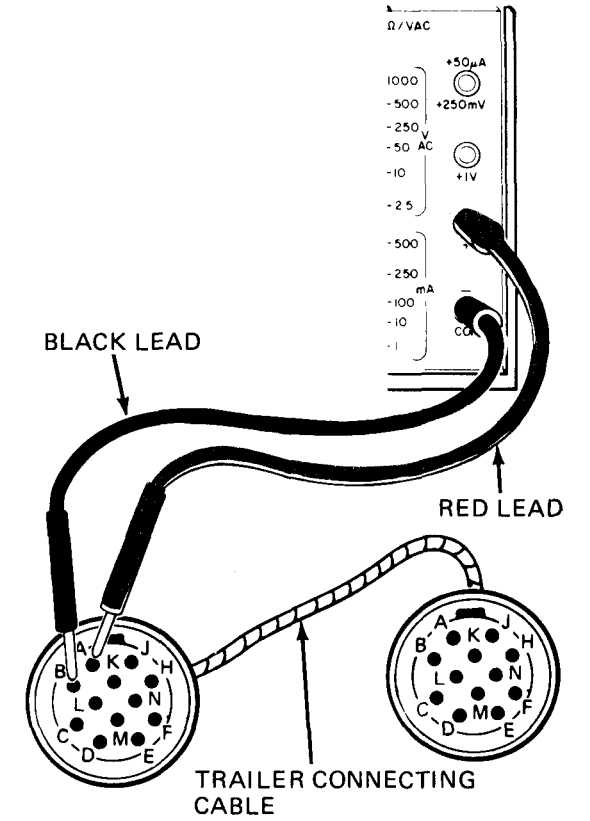
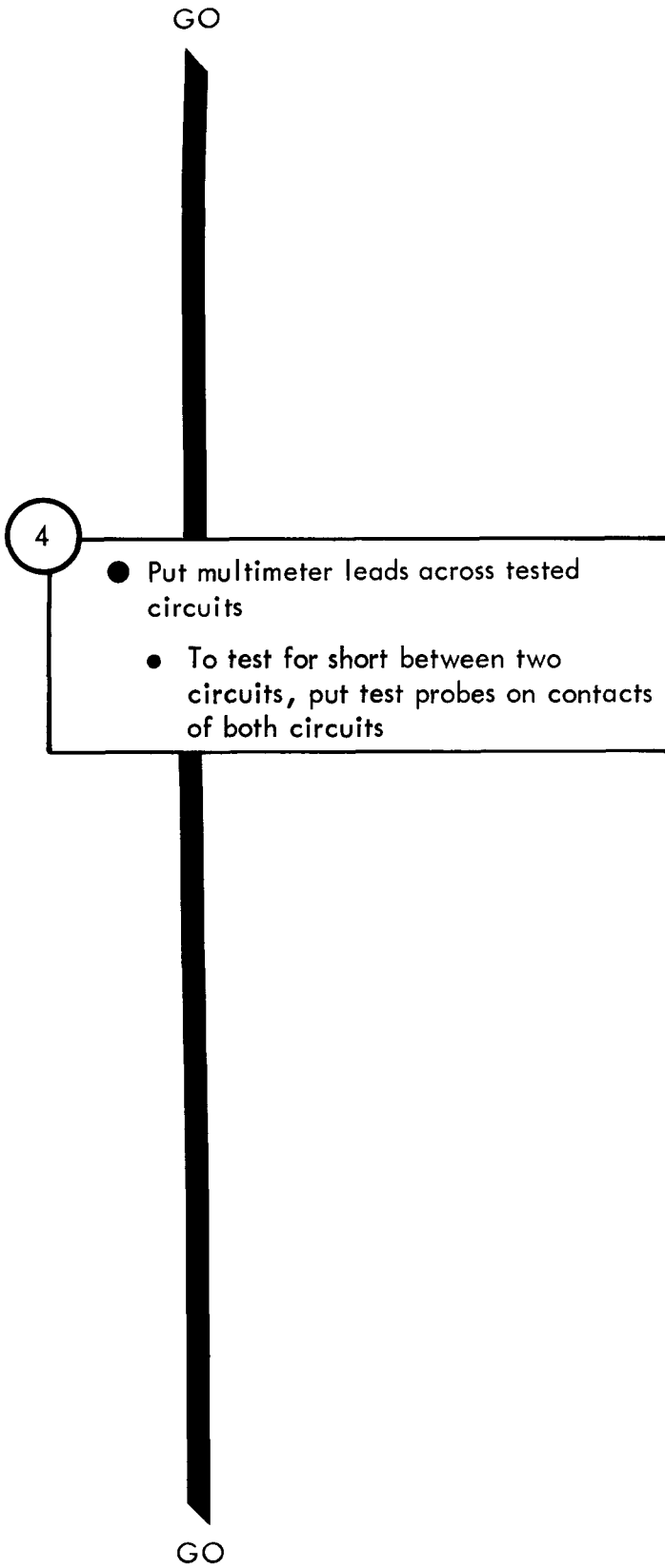
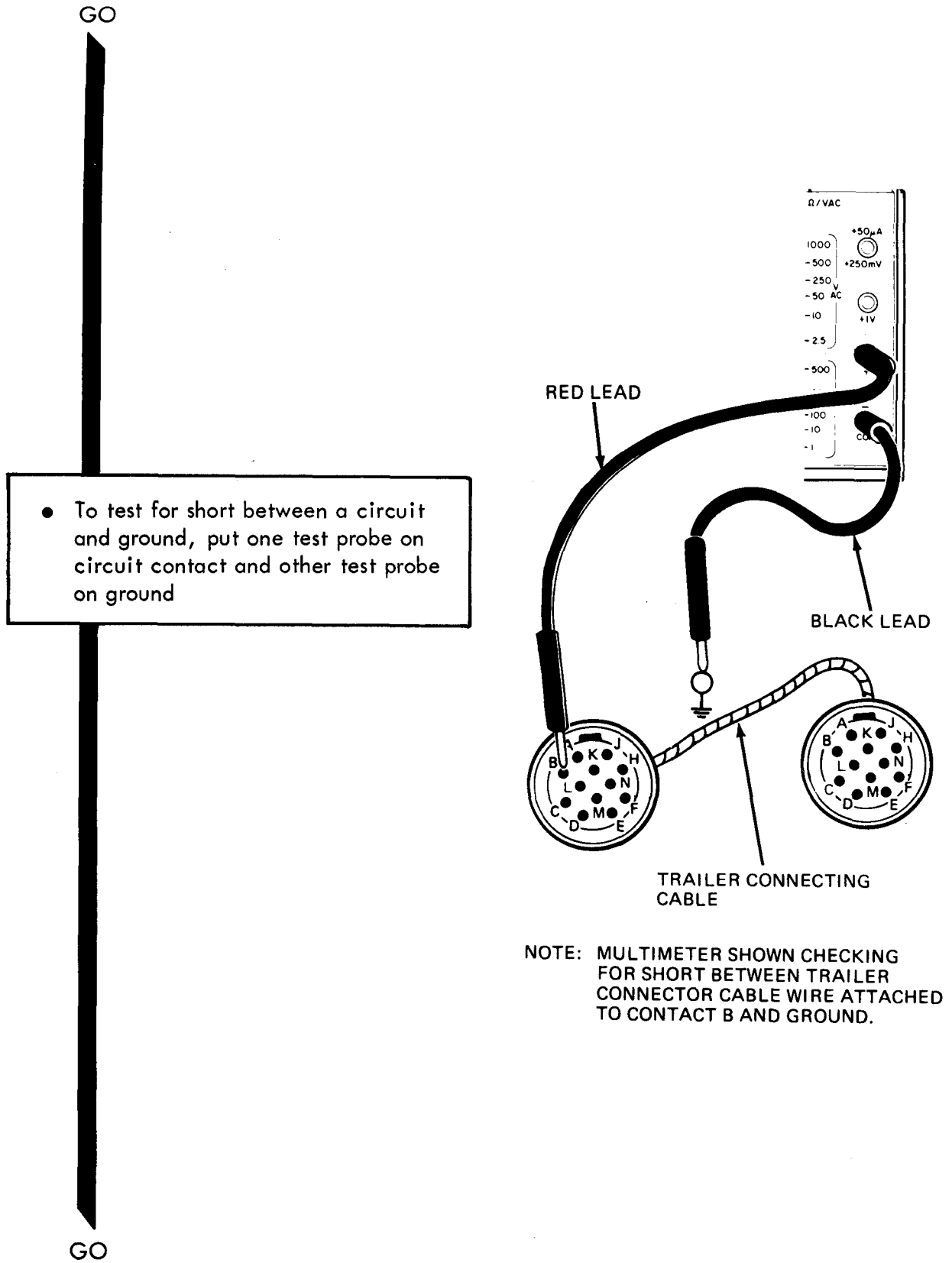

Figure 29-12 (Sheet 4 of 7)



NOTE: MULTIMETER SHOWN CHECKING FOR SHORT BETWEEN TRAILER CONNECTOR CABLE WIRES ATTACHED TO CONTACTS A AND B.



1 DC VOLTAGE TEST - To measure battery voltage, charging system output, and voltage drops at various test points

- 1
- Set up multimeter FUNCTION switch and black test lead:
- Note: The range switch and OHMS ZERO ADJ knob are not used for DC voltage tests
- Set FUNCTION switch to 1000 Ω / VDC
 - Put jack plug of black (-) test lead into -DC \pm AC OHMS jack

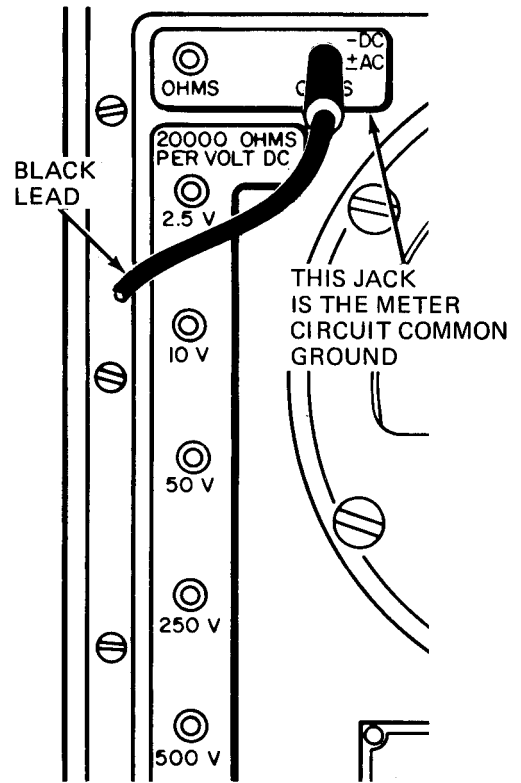
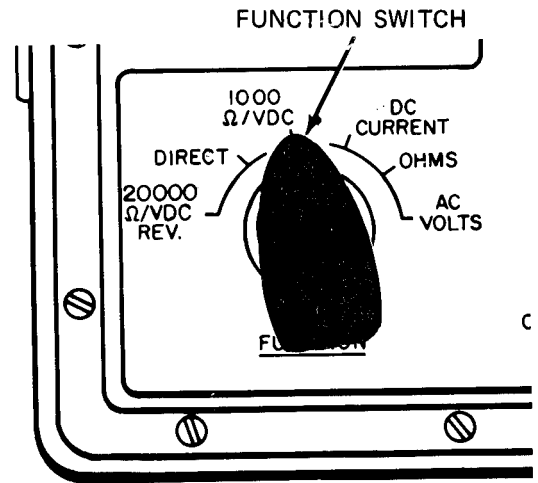

GO

Figure 29-14 (Sheet 1 of 9)

GO

2

- Set up red test lead:

Note: The highest truck DC voltage that is measured is about 28 volts. Therefore, the multimeter red (+) lead is never put into the 250V, 500V, and 1000V jacks

- See table to find out which jack to put red (+) lead into. Table shows which jack to use when normal value of measured voltage is known or unknown

THE JACK USED IS ALWAYS MARKED HIGHER THAN THE VOLTAGE YOU WANT TO MEASURE

IF NORMAL VALUE OF VOLTAGE BEING MEASURED IS THIS:	PUT RED LEAD INTO THIS JACK ON RIGHT SIDE OF MULTIMETER:
0 TO 2 VOLTS	2.5V
2 TO 8 VOLTS	10V
8 TO 40 VOLTS	50V
UNKNOWN	50V

- Put jack plug of red (+) test lead into jack you picked on right side of multimeter. The jacks are in the 1000 OHMS PER VOLT AC DC column of multimeter

NOTE

When you need to turn on power before measuring DC voltage, the fault isolation procedure gives the turn-on instructions

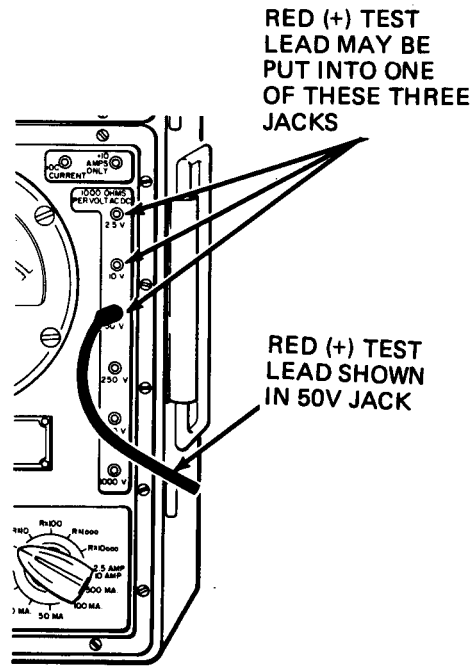

GO

Figure 29-14 (Sheet 2 of 9)

GO

3

- Put multimeter leads across (in parallel with) circuit being measured:
 - Put test prod of black lead (-) on negative terminal of circuit being measured
 - Put test prod of red lead (+) on positive terminal of circuit being measured

NOTE: MULTIMETER SHOWN MEASURING +24 VOLTS DC BATTERY VOLTAGE.

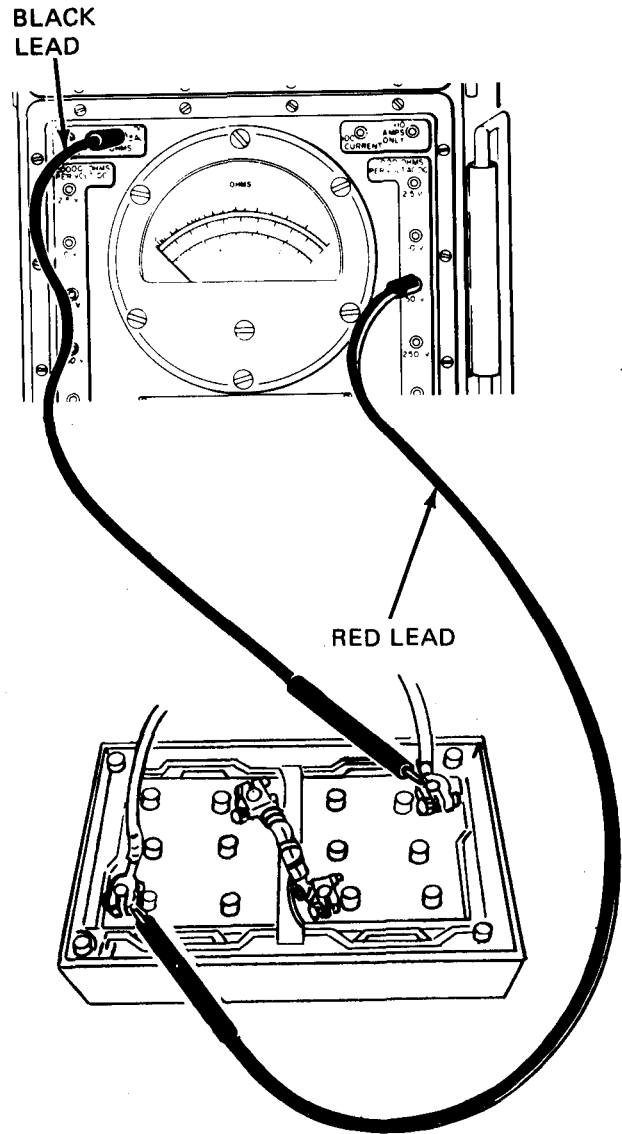

4

- If multimeter red test lead is on 50V jack, read multimeter as follows:
 - Use 5DC scale. Full scale voltage is 50 volts DC

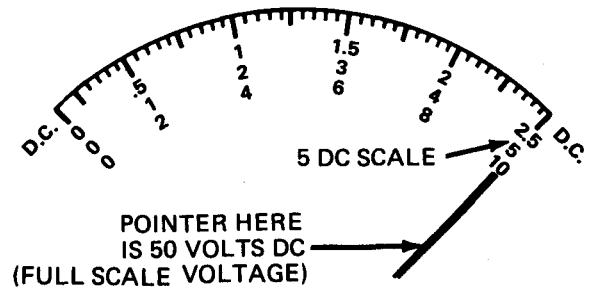

GO

TA 119991

Figure 29-14 (Sheet 3 of 9)

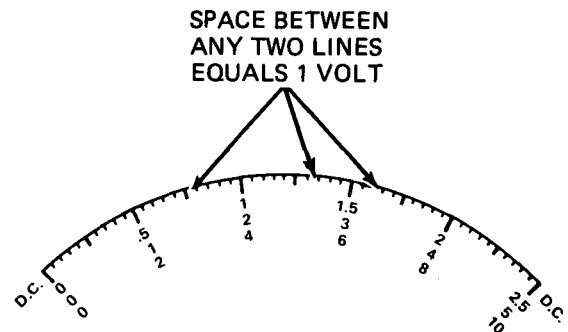
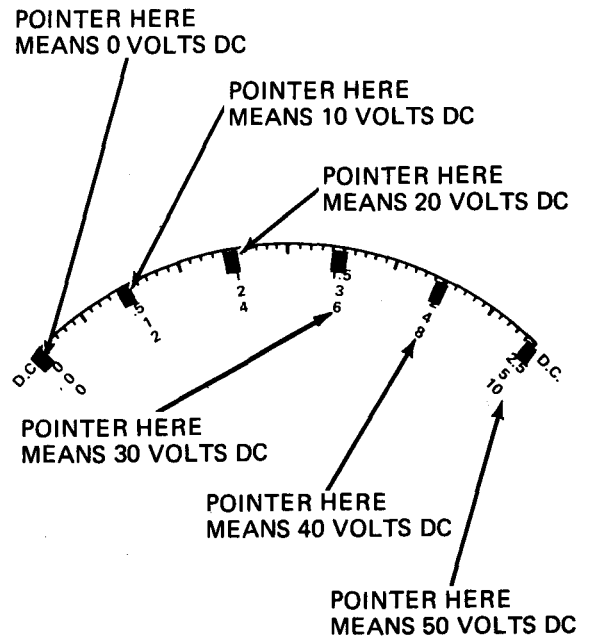
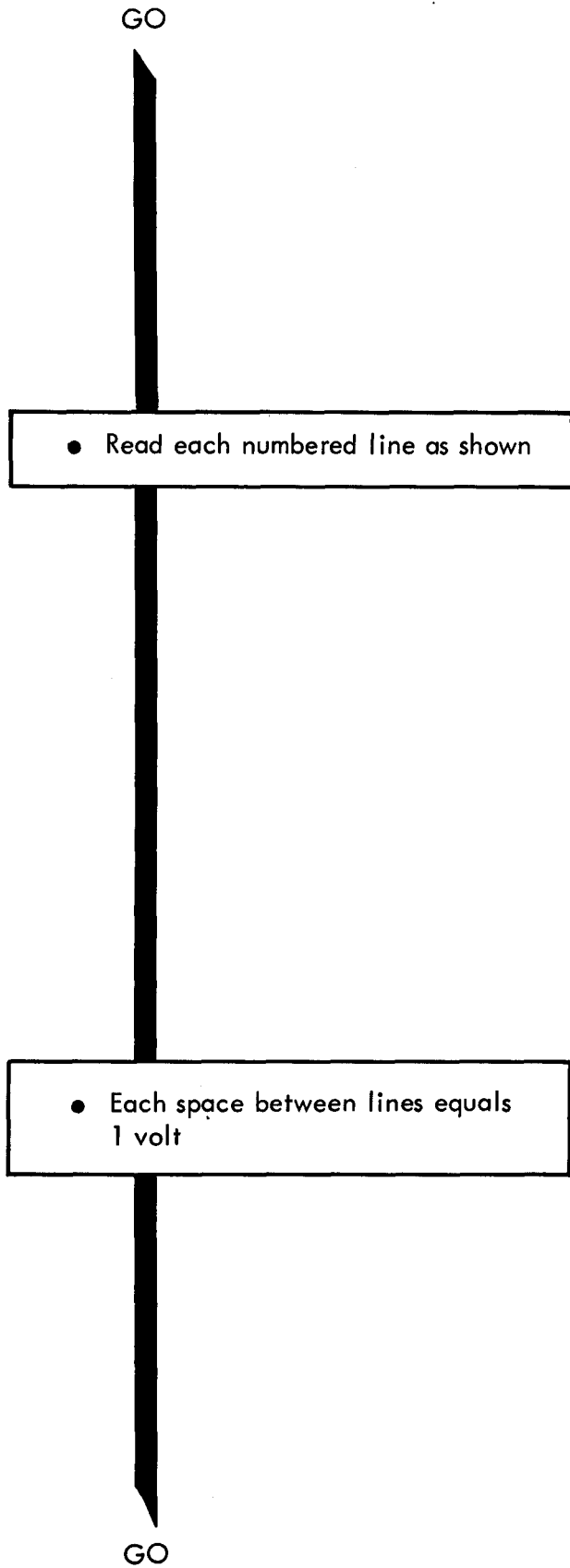

TA 119192

Figure 29-14 (Sheet 4 of 9)

GO

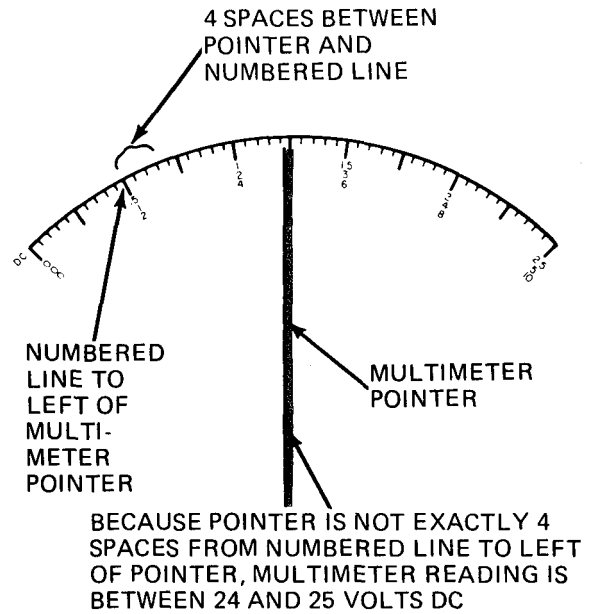

- Get multimeter reading as follows:

Step A

Read first numbered line to left of pointer. Multiply number by 10.

Example: $2 \times 10 = 20 +$

Step B

Count number of spaces between pointer and first numbered line to left of pointer.

4

Step C

Add the numbers from steps A and B.

= 24 volts DC

5

- If multimeter red test lead is in 10V jack, read multimeter as follows:
 - Use 10 DC scale. Full scale voltage is 10 volts DC

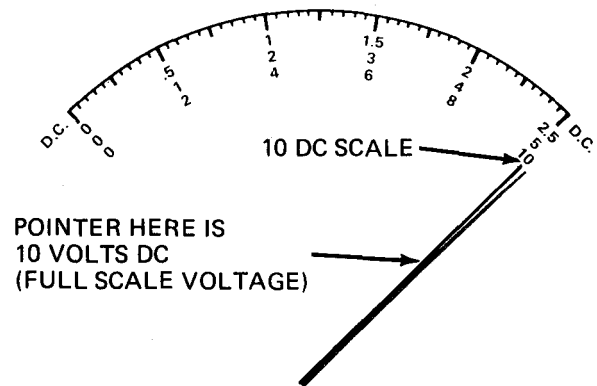

GO

Figure 29-14 (Sheet 5 of 9)

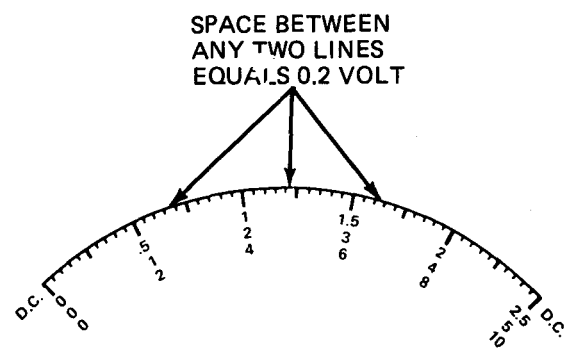
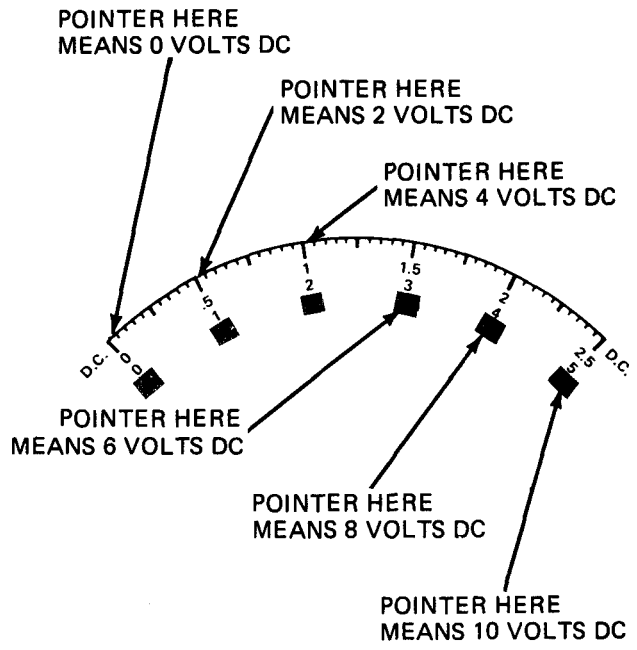
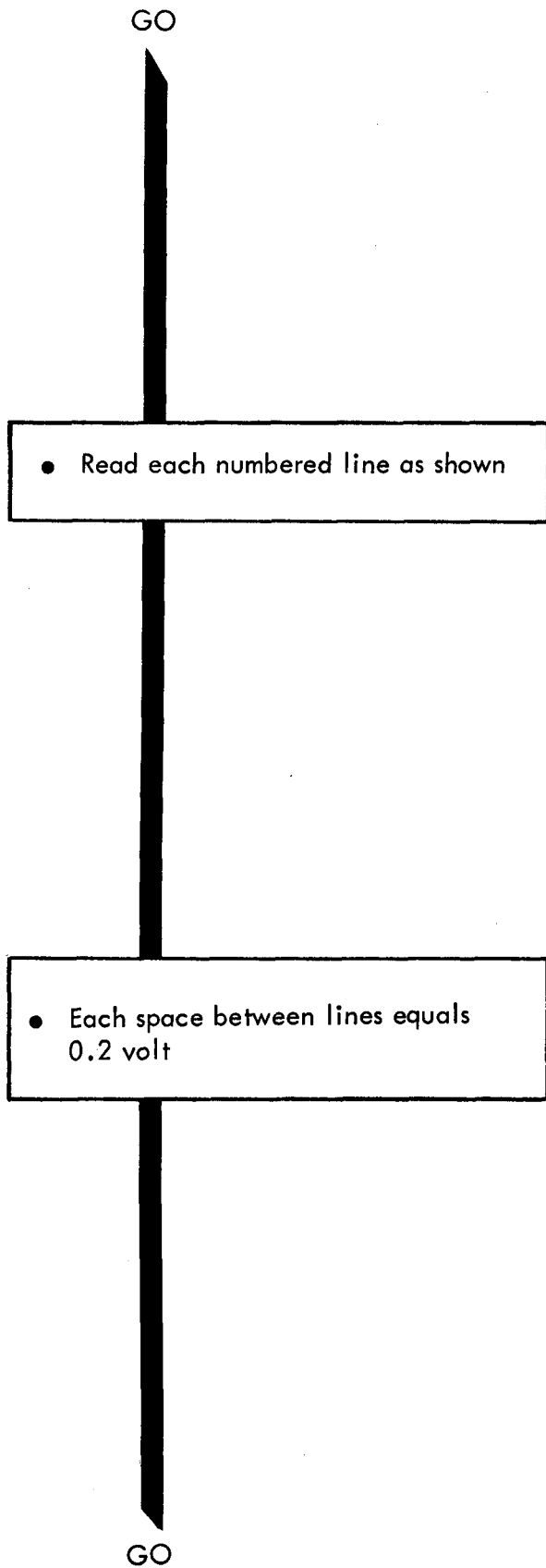
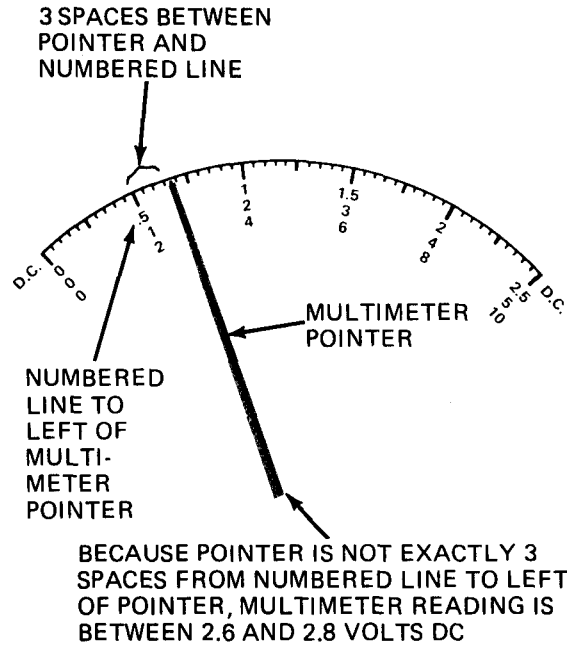

Figure 29-14 (Sheet 6 of 9)

GO



- Get multimeter reading as follows:

Step A

Read first numbered line to left of pointer.

Step B

Count number of spaces between pointer and first numbered line to left of pointer. Multiply number of spaces by 0.2

Step C

Add the numbers from steps A and B.

Example 2

+

$$0.2 \times 3 = 0.6$$

$$= 2.6 \text{ volts DC}$$

6

- If multimeter red test lead is in 2.5V jack, read multimeter as follows:
 - Use 2.5 DC scale. Full scale voltage is 2.5 volts DC

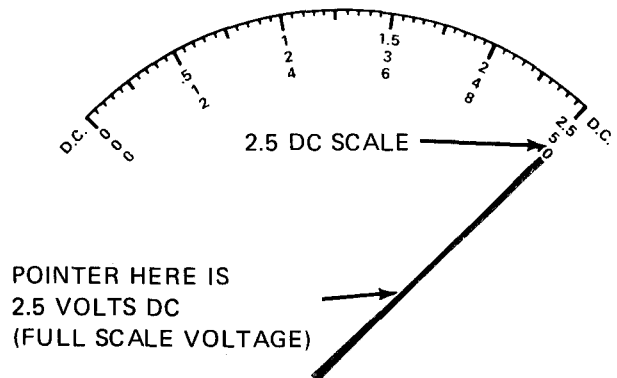

GO

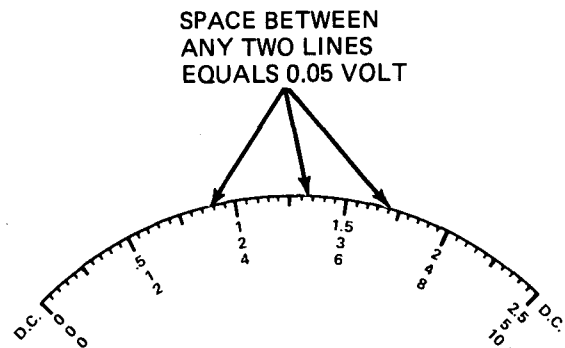
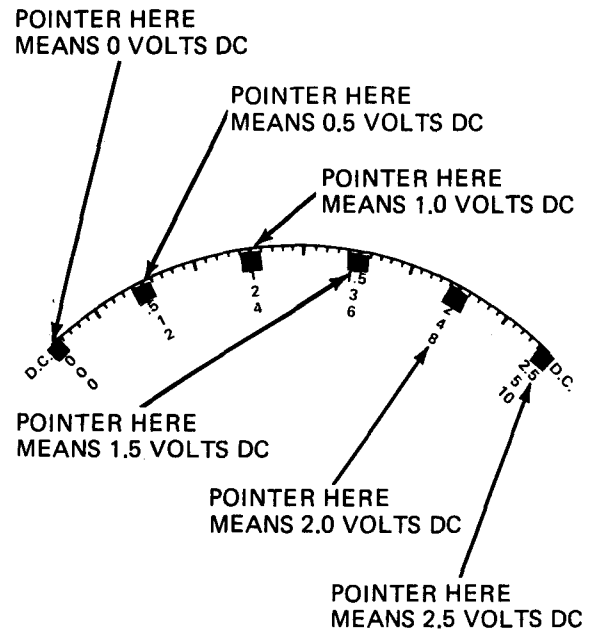
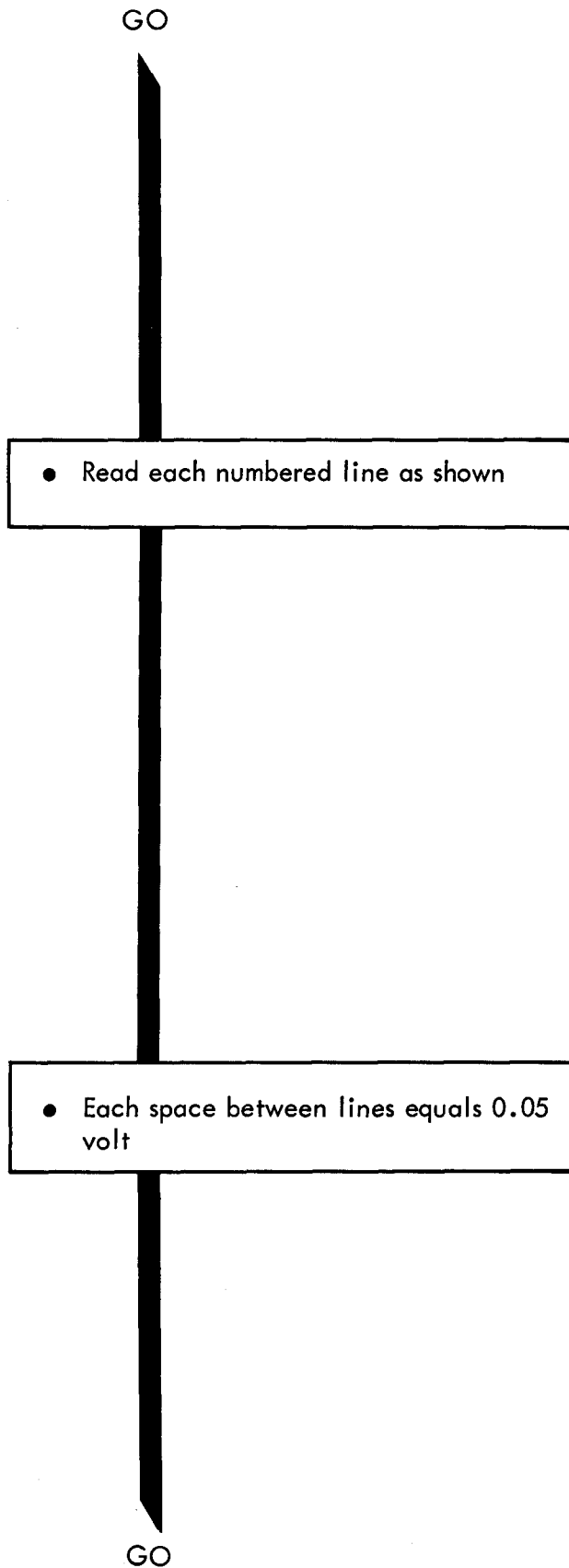
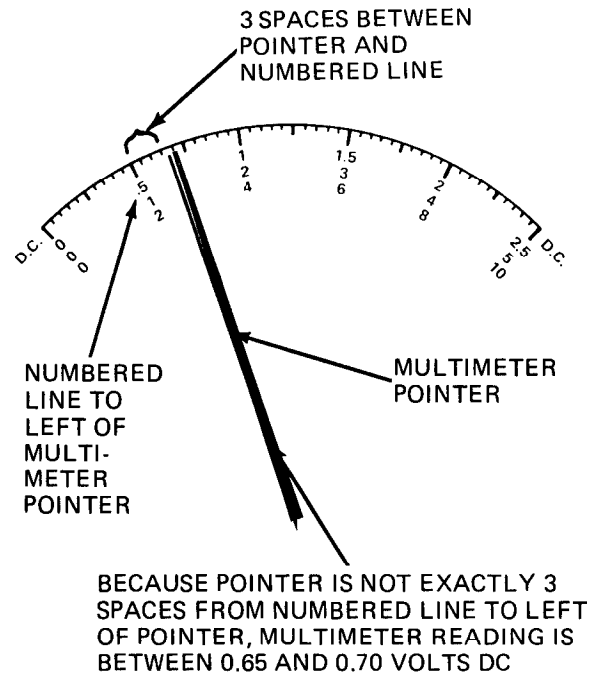

Figure 29-14 (Sheet 8 of 9)

TA 119996

GO



- Get multimeter reading as follows:

Step A

Read first numbered line to left of pointer.

Step B

Count number of spaces between pointer and first numbered line to left of pointer. Multiply number of spaces by 0.05.

Step C

Add the numbers from steps A and B.

Example: 0.5 + 0.05 x 3 = 0.15 = 0.65 volts DC

7

- Make circuit normal again:
 - Take both test prods off measured circuit

2 AC VOLTAGE TEST - To measure van input and operating voltages

- 1
- Set up multimeter as follows
- Note: The range switch and OHMS ZERO ADJ knob are not used for AC voltage tests
- Set FUNCTION switch to AC VOLTS

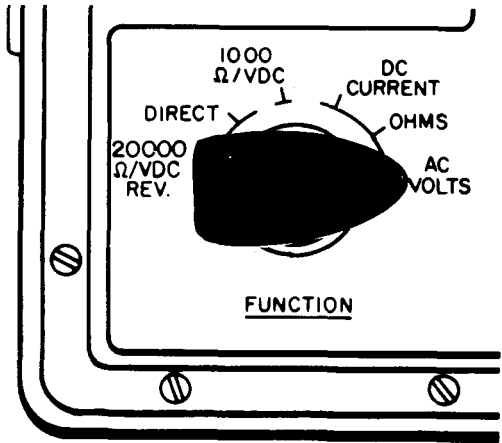

- Put jack plug of black test lead into -DC ±AC OHMS jack

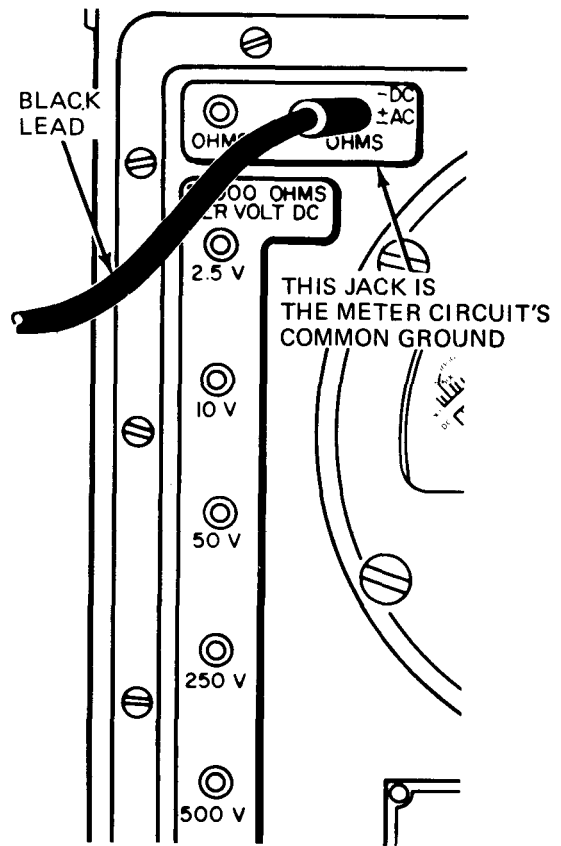

GO

Figure 29-15 (Sheet 1 of 5)

GO

- Put jack plug of red test lead into 250 V jack on right side of multimeter. The jack is in the 1000 OHMS PER VOLT AC DC column

Note: The truck AC voltages measured are 208 and 120 volts. Therefore, the multimeter red lead is never put into the 2.5 V, 10 V, 50 V, 500 V, and 1000 V jacks

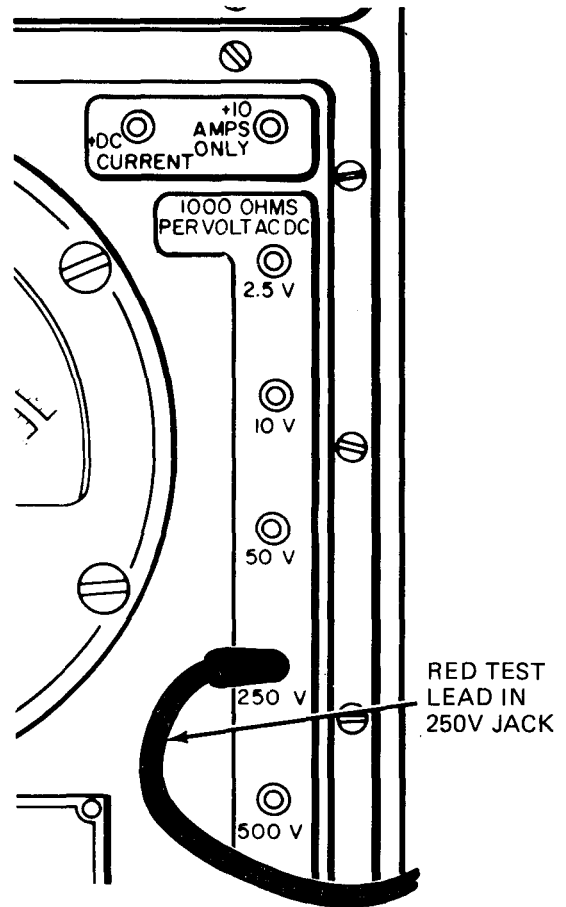

NOTE

When you need to turn on power before measuring AC voltage, the fault isolation procedure gives the turn-on instructions

GO

GO

2

- Put multimeter leads across (in parallel with) circuit being measured
- Note: In AC voltage measurement you can hook up the test lead connections to the circuit either way. You will still get correct multimeter readings and no damage will be done to the multimeter. But, when one side of the circuit is electrical ground, it is a good idea to put the black lead on electrical ground
- Put test prod of black lead on ground side or one side of circuit being measured. Put test prod of red lead on other side of circuit being measured

NOTE: MULTIMETER SHOWN MEASURING 120 VOLTS AC VAN CEILING LIGHT VOLTAGE.

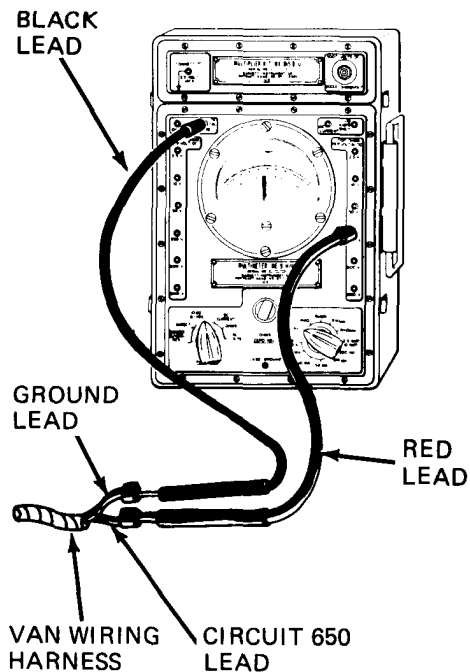

3

- Read multimeter
- Use 2.5 AC scale. Full scale voltage is 250 volts AC

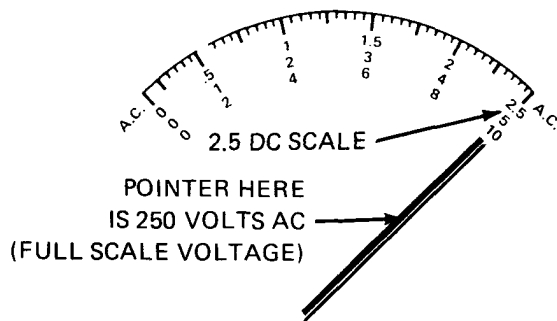

GO

Figure 29-15 (Sheet 3 of 5)

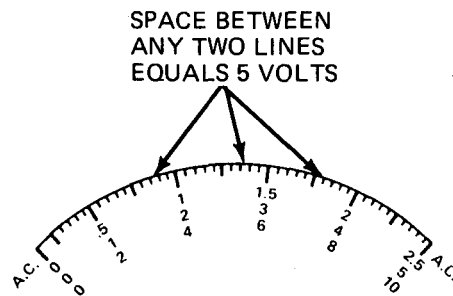
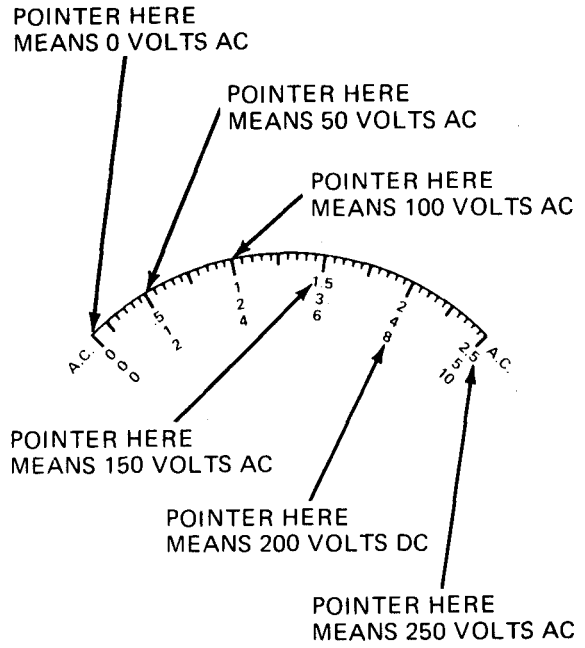
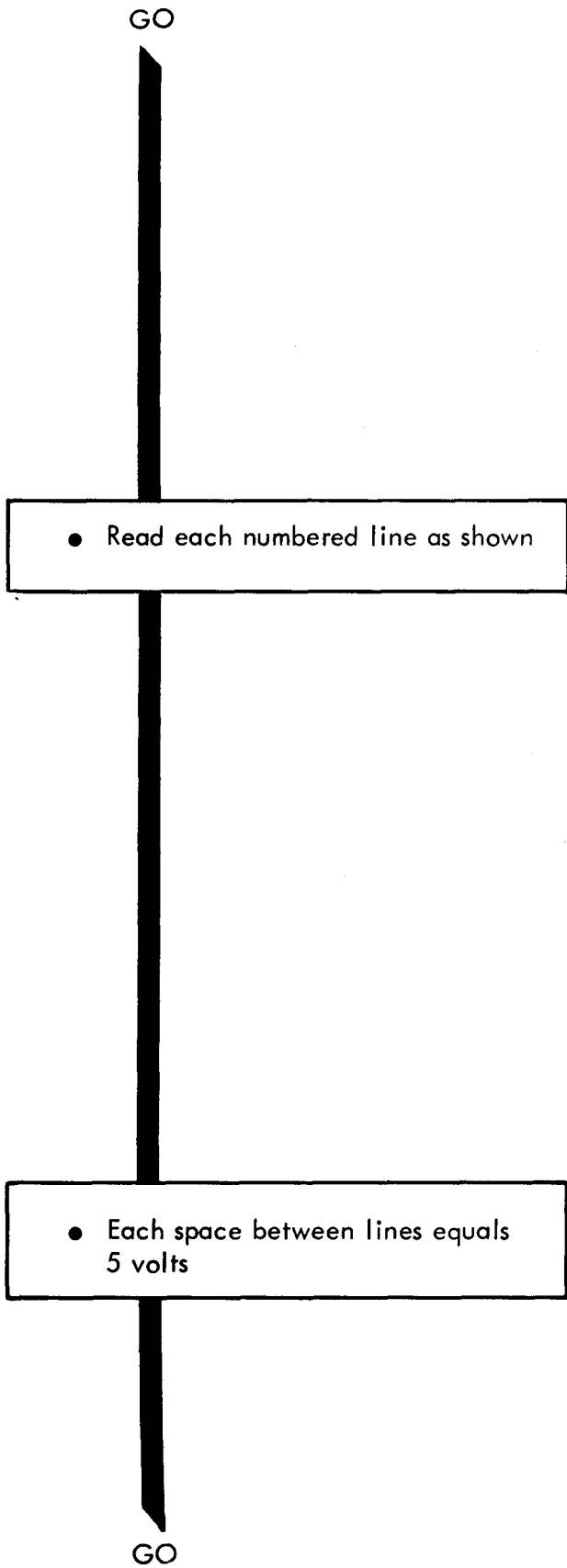

TA 120001

Figure 29-15 (Sheet 4 of 5)

GO

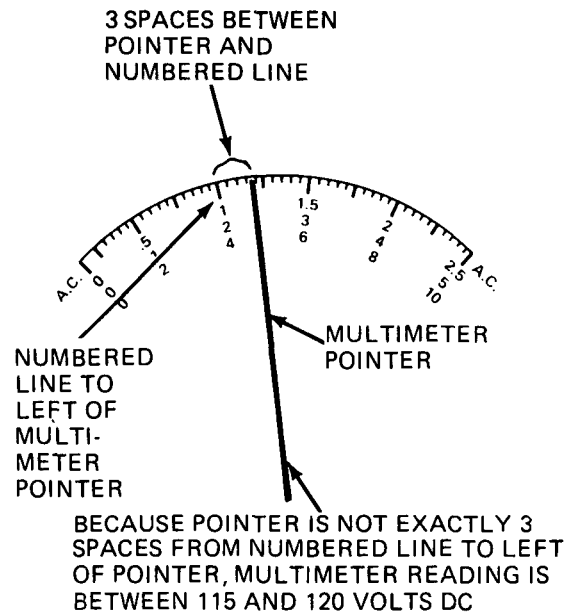

- Get multimeter reading as follows:

Step A

Read first numbered line to left of pointer. Multiply number by 100.

Step B

Count number of spaces between pointer and first numbered line to left of pointer. Multiply number of spaces by 5.

Step C

Add the numbers from steps A and B.

Example: $1 \times 100 = 100 + 5 \times 3 = 15 = 115 \text{ volts AC}$

4

- Make circuit normal again
 - Take both test prods off measured circuit

Figure 29-15 (Sheet 5 of 5)

3 RESISTANCE TEST - To measure resistance of temperature sending unit, and blower motor resistor

- 1
- Set up multimeter:
 - Set FUNCTION switch to OHMS

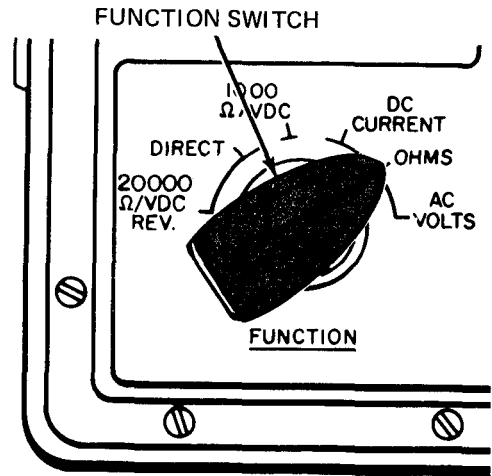

- Set range switch to RX10000

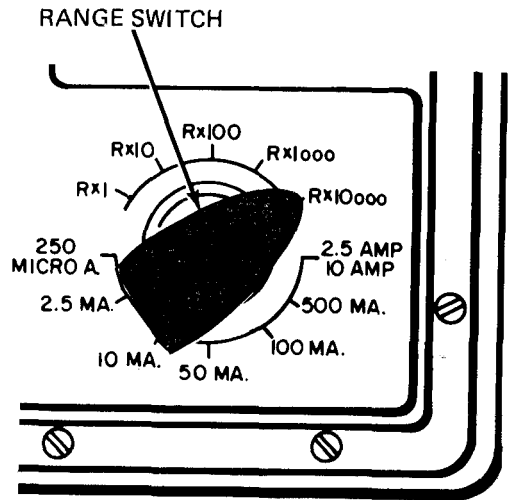

GO

Figure 29-16 (Sheet 1 of 10)

GO

- Put jack plug of black (-) test lead into -DC ±AC OHMS jack
- Put jack plug of red (+) test lead into OHMS jack

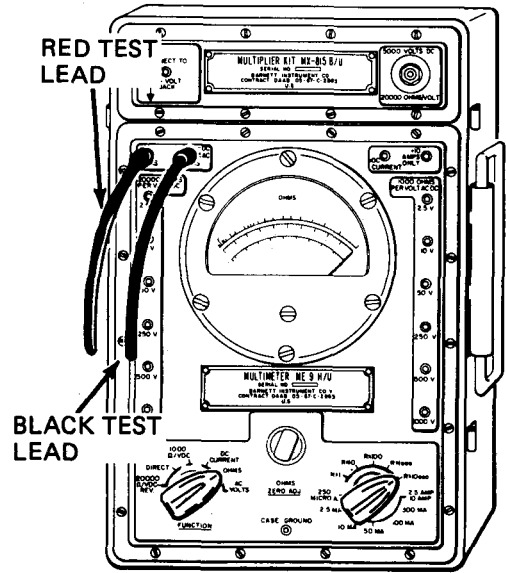

NOTE

Detailed steps for making the truck parts ready for resistance test are in the fault isolation procedures. The steps given here are typical

2

- Make tested part ready for resistance test:

--- CAUTION ---
If power to tested part is not turned off, multimeter will be damaged

GO

Figure 29-16 (Sheet 2 of 10)

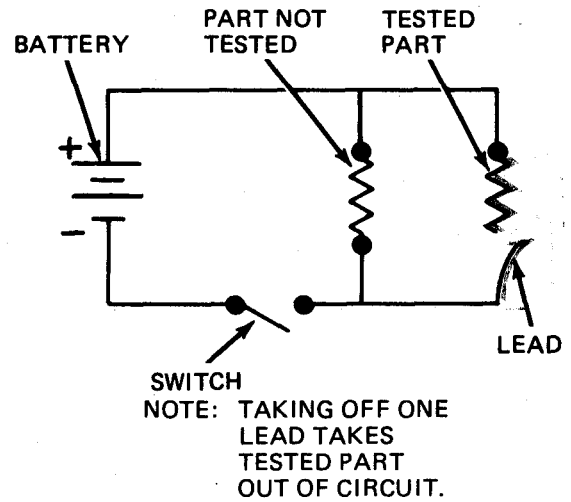
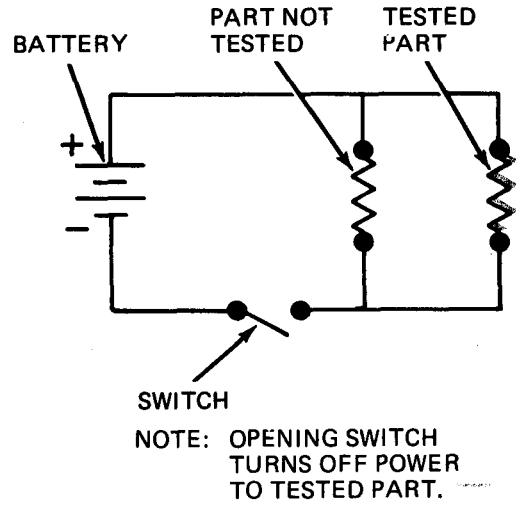
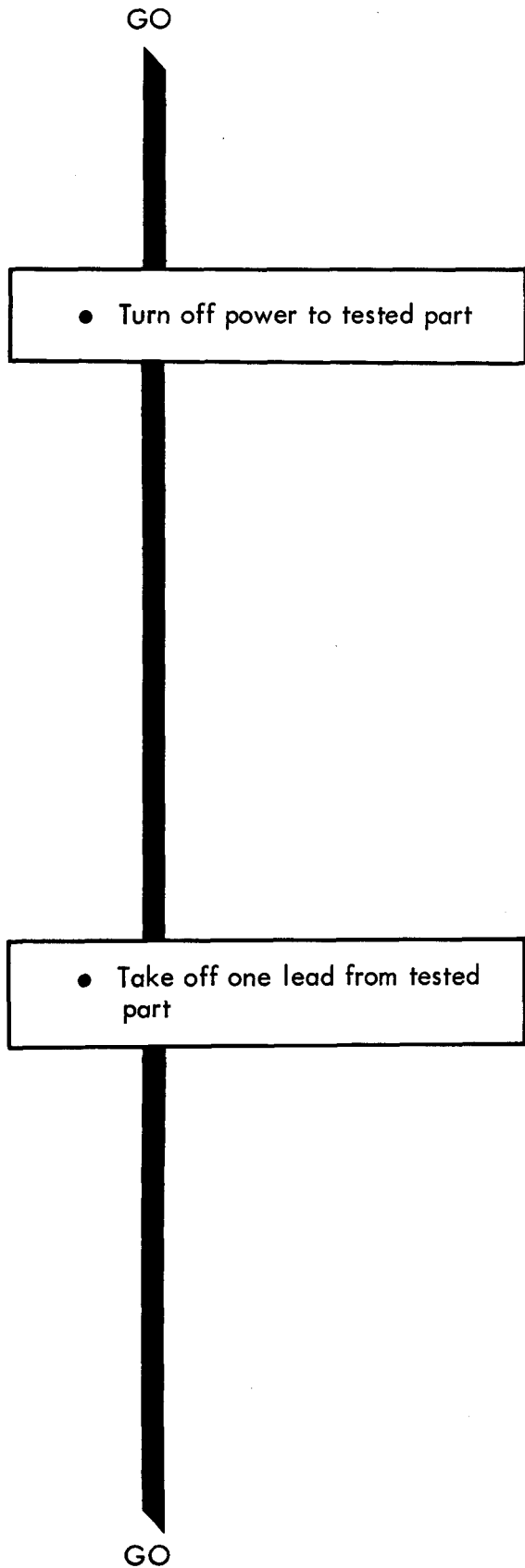
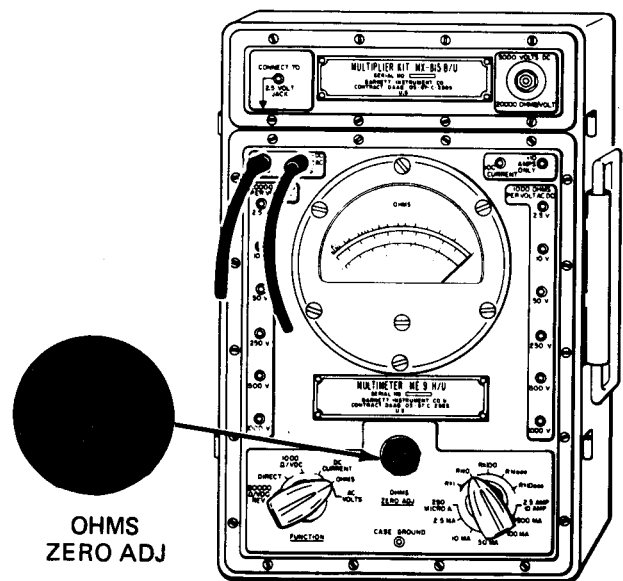
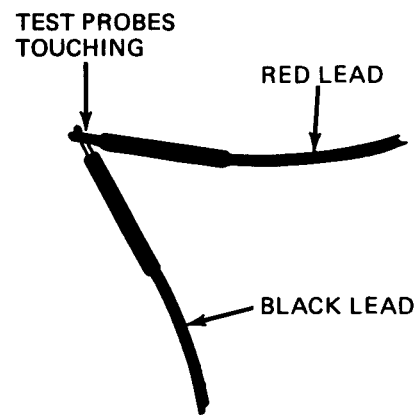
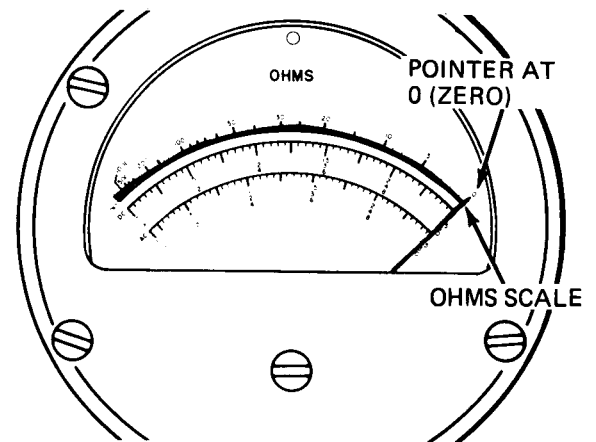
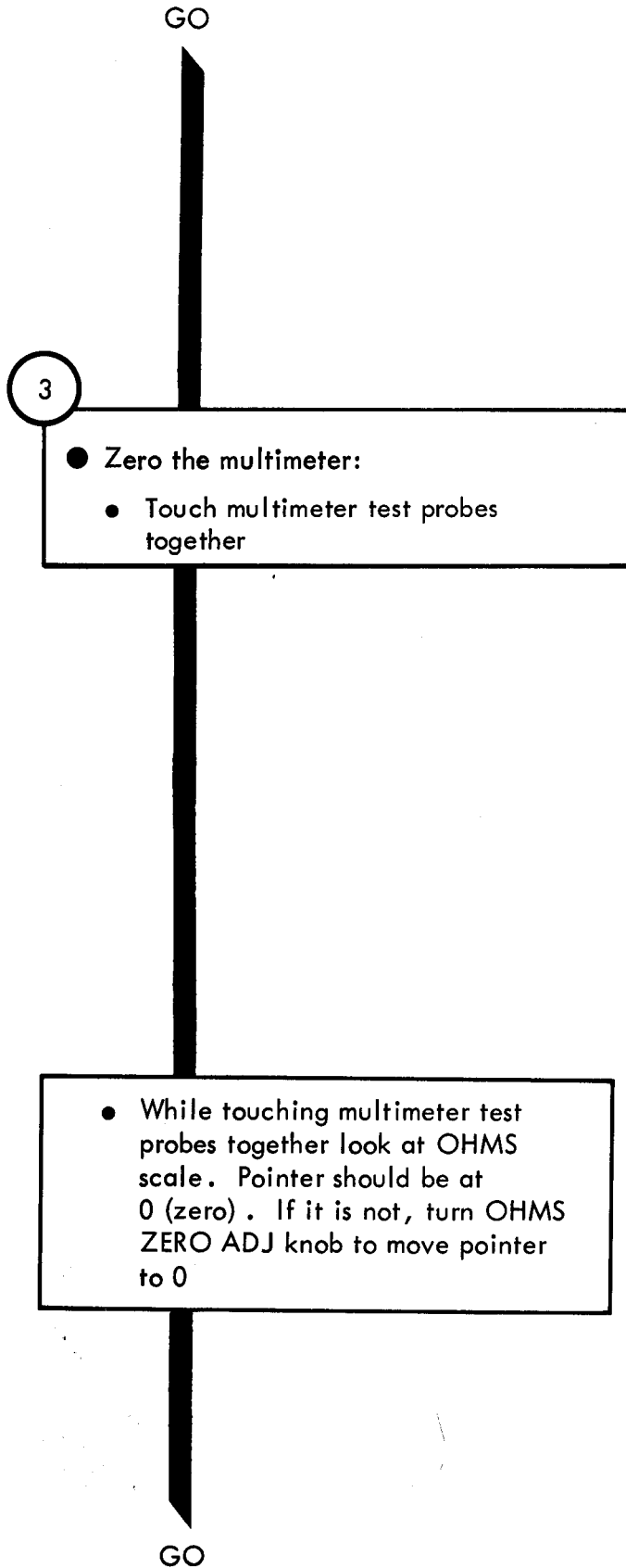

Figure 29-16 (Sheet 3 of 10)



TA 120006

Figure 29-16 (Sheet 4 of 10)

GO

4

- Put multimeter leads across tested part:
 - Put one test prod on one terminal of tested part
 - Put other test prod on other terminal of tested part

NOTE

Zero the multimeter each time you turn the range switch knob to another position. (See step 3 .)

5

- Get the most accurate multimeter reading as follows:
 - Note: The closer the multimeter pointer is to the center of the OHMS scale, the more accurate the reading
 - Note position of pointer on OHMS scale. Turn range switch knob to left while looking at pointer. Try to find range switch knob position that gives most centered pointer position

GO

NOTE: MULTIMETER SHOWN MEASURING RESISTANCE OF A COLD START RESISTOR

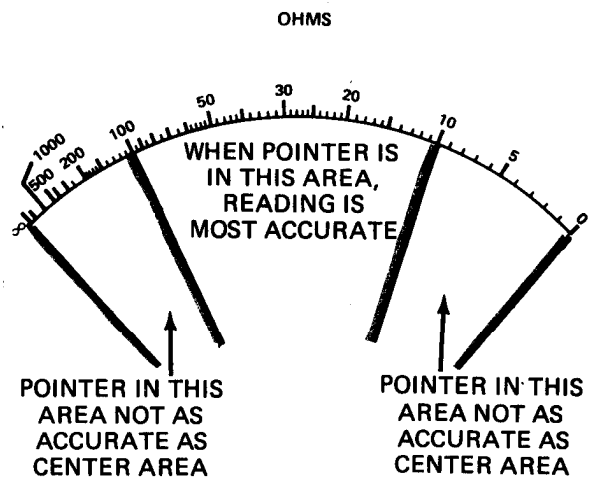
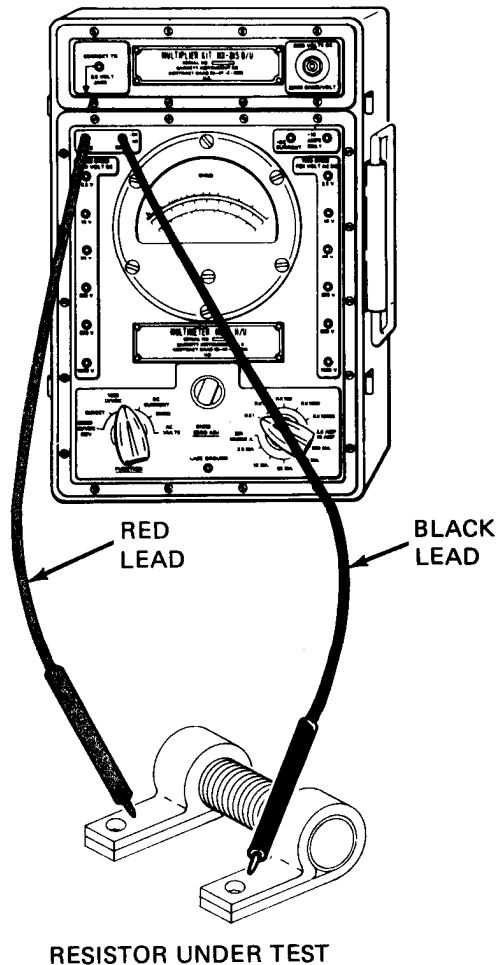

TA 120007

Figure 29-16 (Sheet 5 of 10)

GO

- You may overshoot most centered pointer position. If you do, turn range switch knob to right to put pointer in most centered position

GO

ONLY THESE RANGE SWITCH POSITIONS USED FOR RESISTANCE MEASUREMENTS

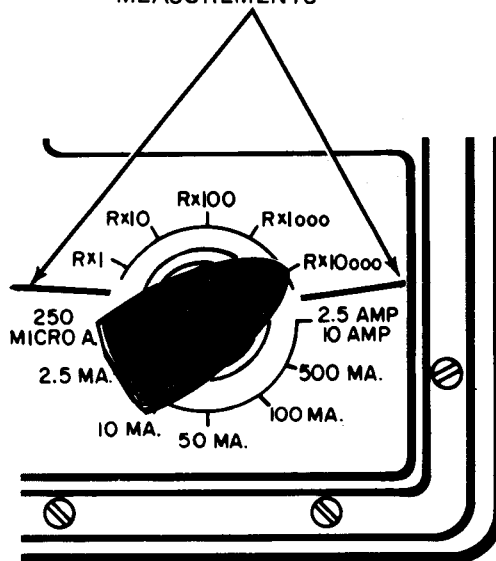

NOTE: MOVING RANGE SWITCH KNOB TO LEFT MOVES POINTER TO LEFT.

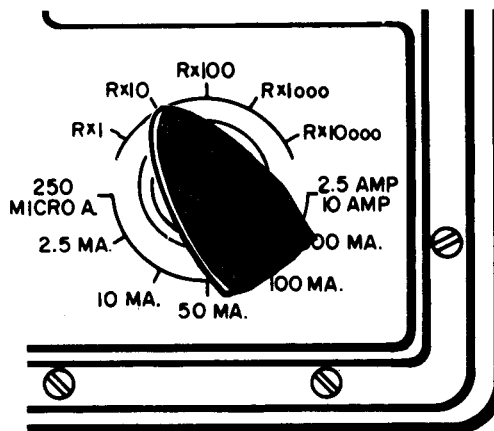

NOTE: MOVING RANGE SWITCH KNOB TO RIGHT MOVES POINTER TO RIGHT.

TA 120008

Figure 29-16 (Sheet 6 of 10)

GO

- Pointer will stay in right area if resistance is less than 10 ohms. Pointer will stay in left area if resistance is more than 1,000,000 ohms
- Leave range switch in position that puts pointer in most centered position

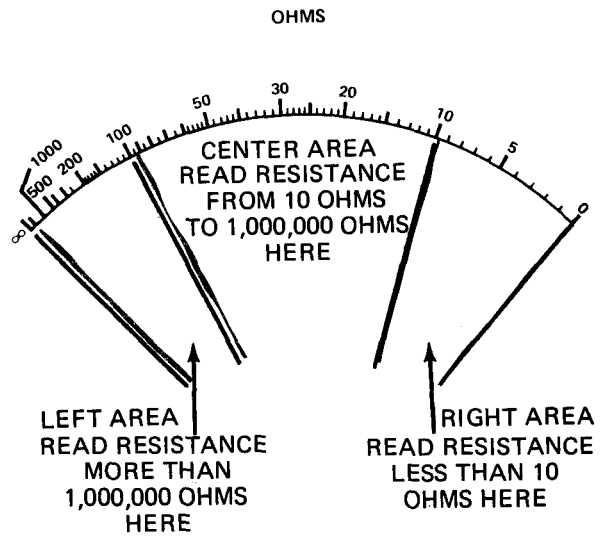

6

- If pointer falls exactly on a numbered line read multimeter as follows:
 - Look at OHMS scale and see which numbered line pointer is on: 50

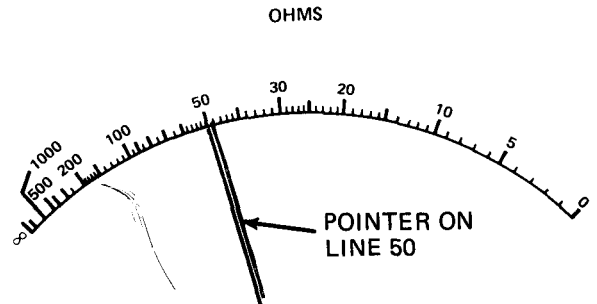

- See what range switch position number is: 10
- Multiply number from step a by number from step b to get multimeter reading:
 $50 \times 10 = 500 \text{ Ohms}$

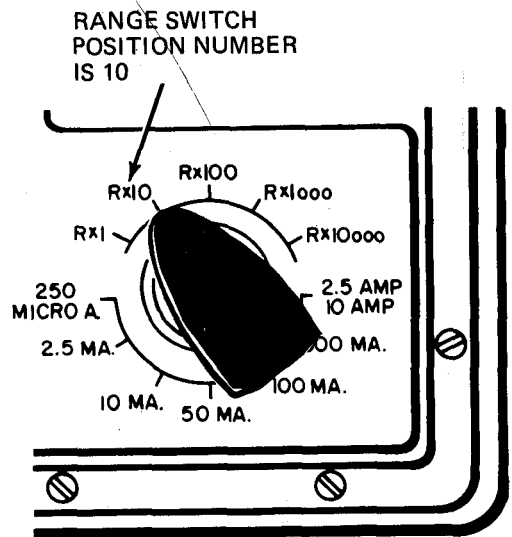

GO

Figure 29-16 (Sheet 7 of 10)

GO

7

- If pointer falls between numbered lines read multimeter as follows:
 - a. Look at OHMS scale and note the numbers to left and right of pointer: 30 and 20
 - b. Subtract lower number from higher number:
 $30 - 20 = 10$

c. Count number of graduations from lower number to higher number. (If pointer is to left of number 50, count only the longer graduations.): 10

GO

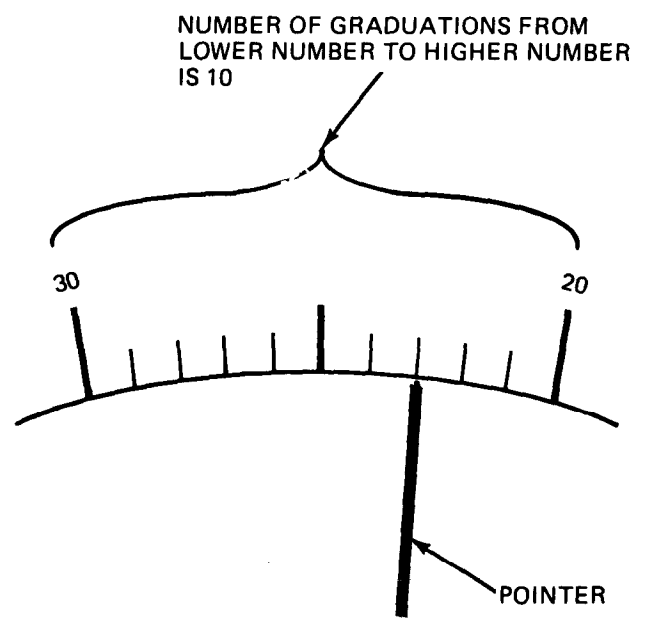
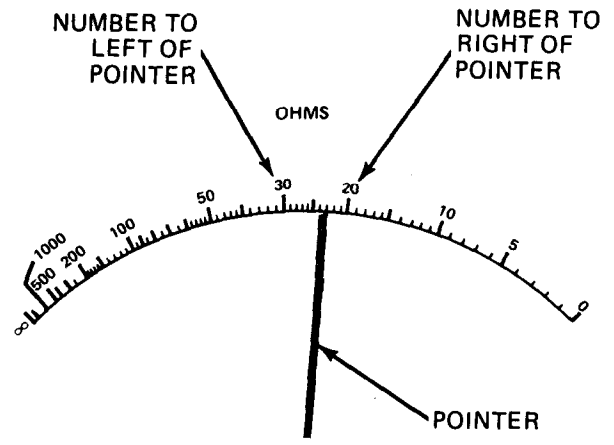

Figure 29-16 (Sheet 8 of 10)

GO

d. Divide number from step b by number of graduations counted from step c:
 $10 \div 10 = 1$

e. Count number of graduations from lower number to pointer. (If pointer is to left of number 50, count only the longer graduations): 3

f. Multiply number of graduations counted in step e by answer from step d: $3 \times 1 = 3$

g. Add answer from step f to lower number to get scale reading:
 $3 + 20 = 23$

GO

NUMBER OF GRADUATIONS FROM LOWER NUMBER TO POINTER IS 3

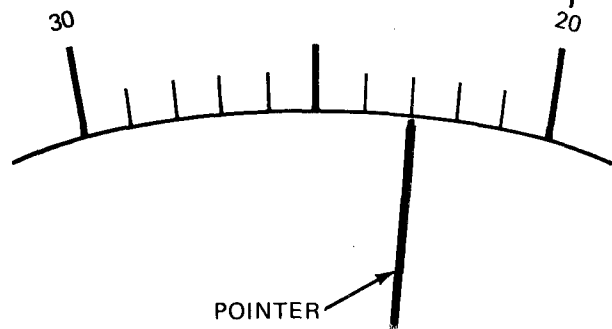

LOWER NUMBER

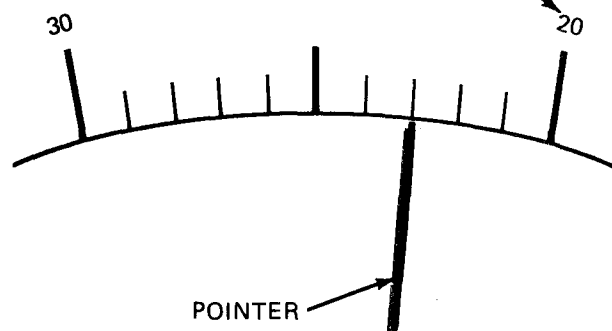
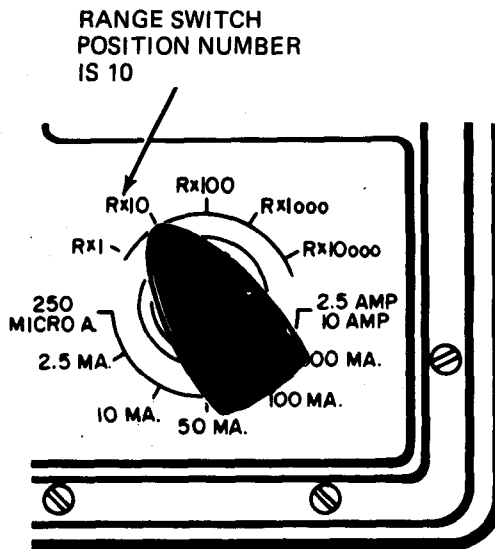

Figure 29-16 (Sheet 9 of 10)

GO

h. Multiply scale reading (step g) by range switch position number to get multimeter reading:
 $23 \times 10 = 230$ ohms



8

- Put tested part back in circuit:
 - Take off both test prods from across tested part
 - Put lead back on tested part

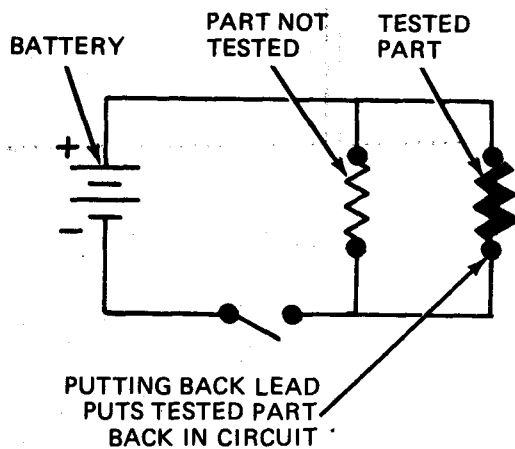
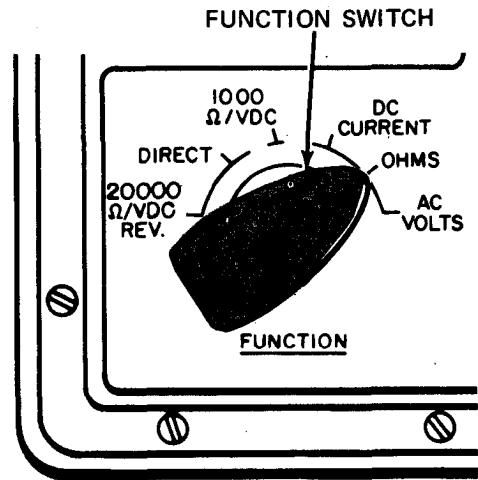

Figure 29-16 (Sheet 10 of 10)

3 CONTINUITY TEST - To check for breaks in a circuit, such as switch, lamp or electrical cable circuits

- 1
- Set up multimeter:
 - Set FUNCTION switch to OHMS



- Set range switch to RX1

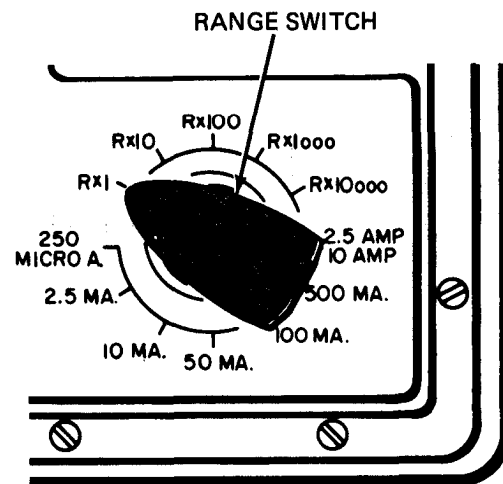

GO

TA 120013

Figure 29-17 (Sheet 1 of 6)

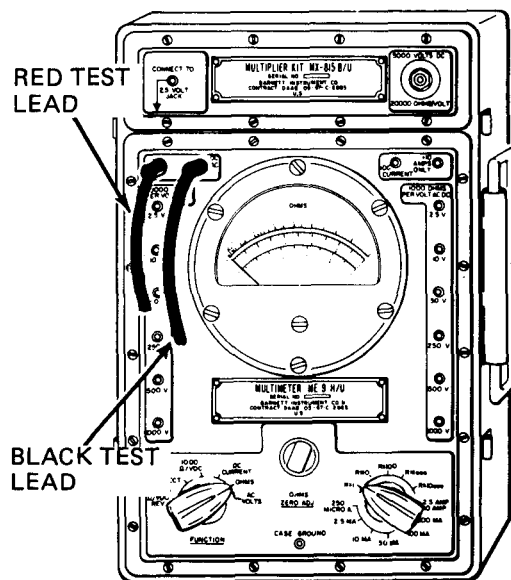
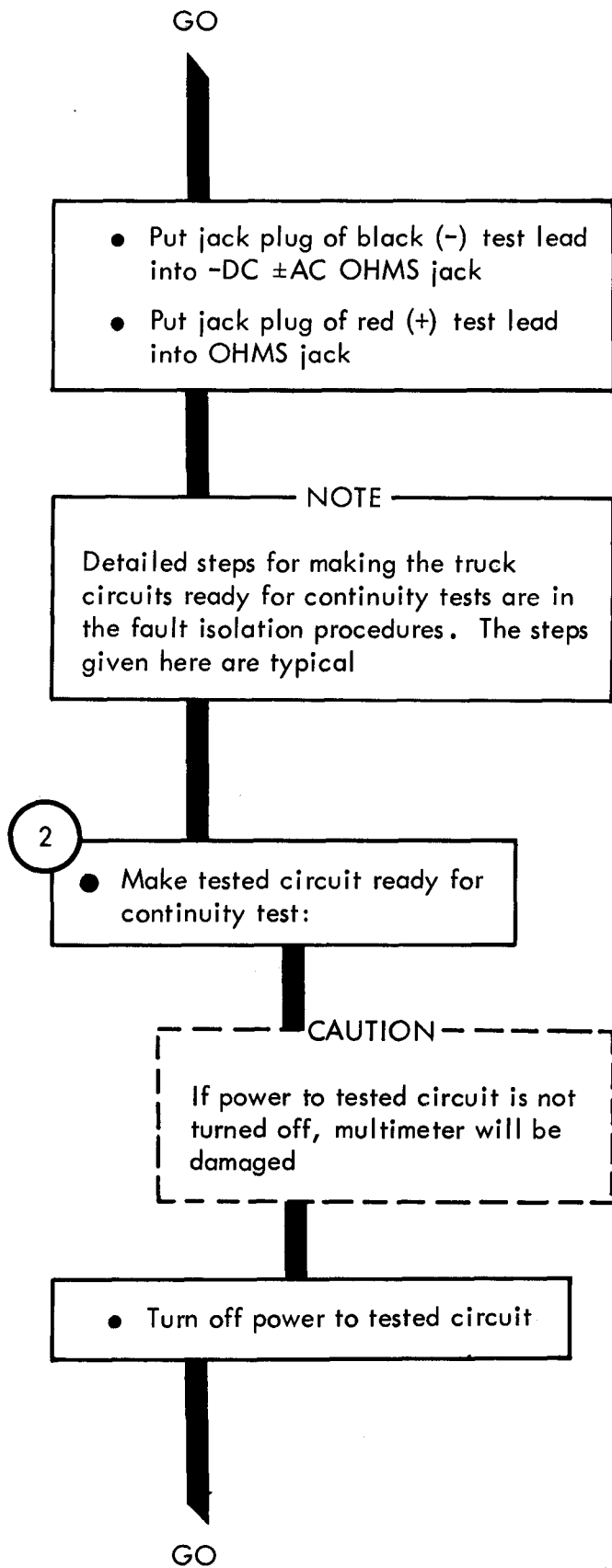

SETTING LIGHT SWITCH MAIN LEVER TO OFF TURNS OFF POWER TO LIGHT CIRCUITS.

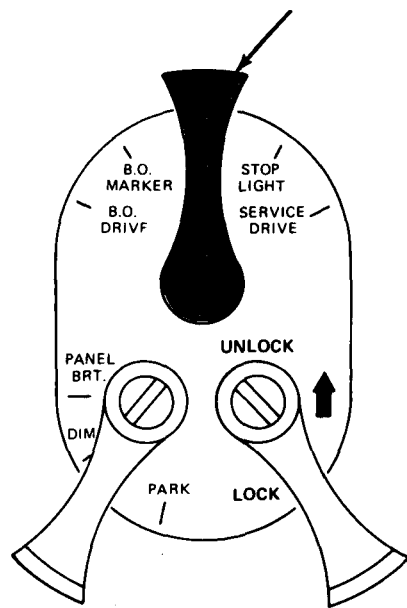
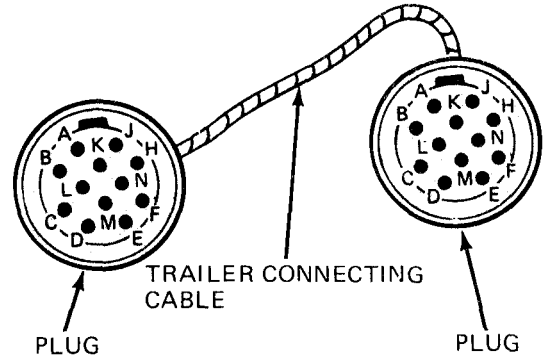

Figure 29-17 (Sheet 2 of 6)

GO

- Take plug on each end of trailer connecting cable off mating receptacle

TAKING CABLE PLUGS OFF MATING RECEPTACLES LETS YOU TEST CONTINUITY OF CABLE WIRES



3

- Zero the multimeter:
 - Touch multimeter test probes together

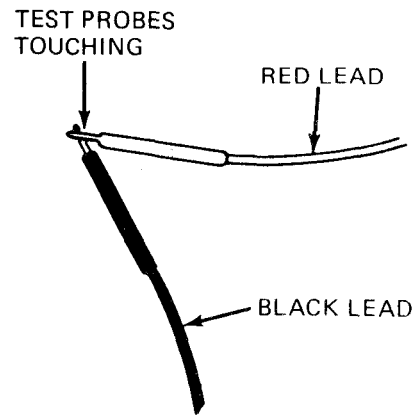

GO

Figure 29-17 (Sheet 3 of 6)

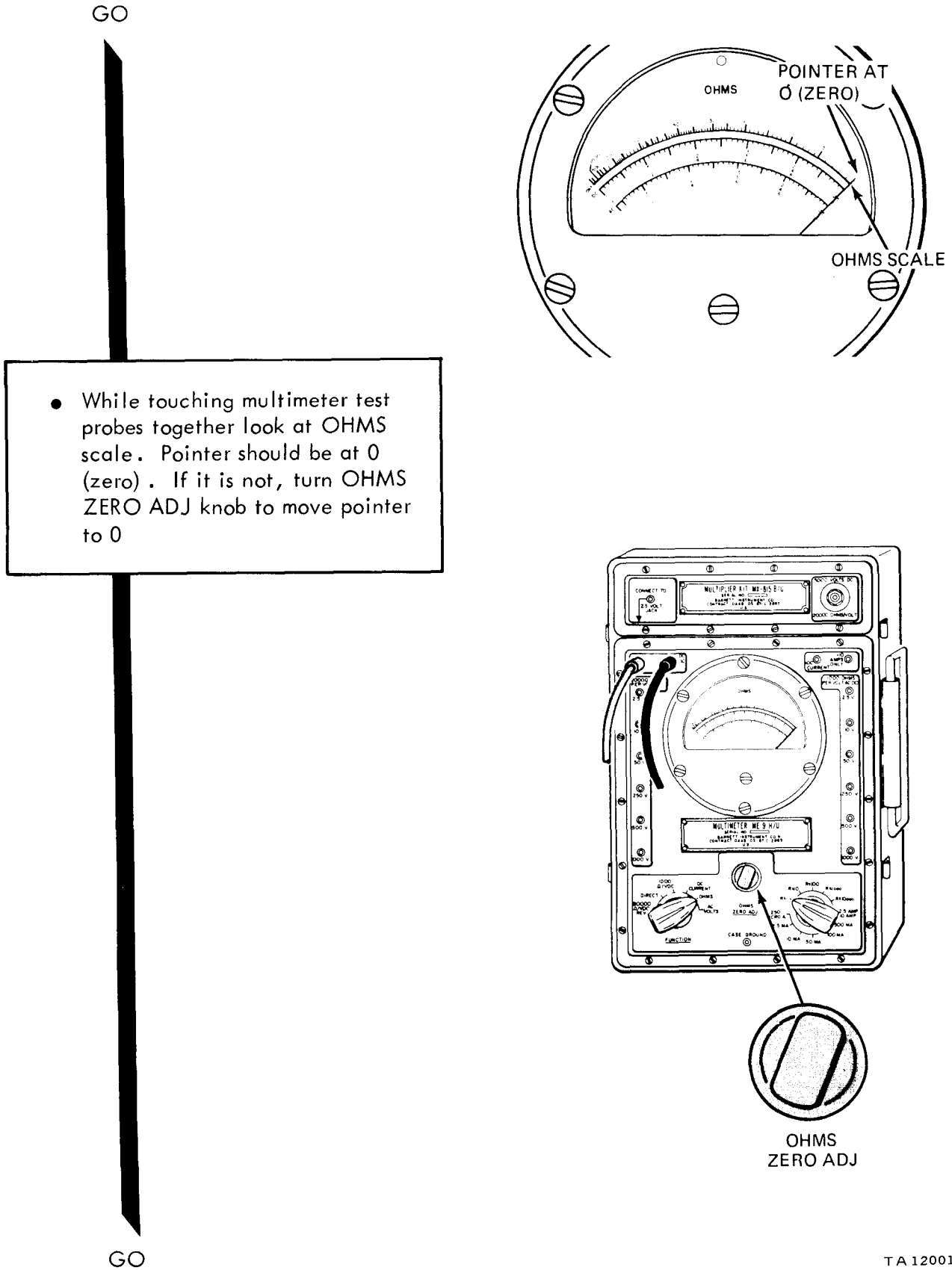
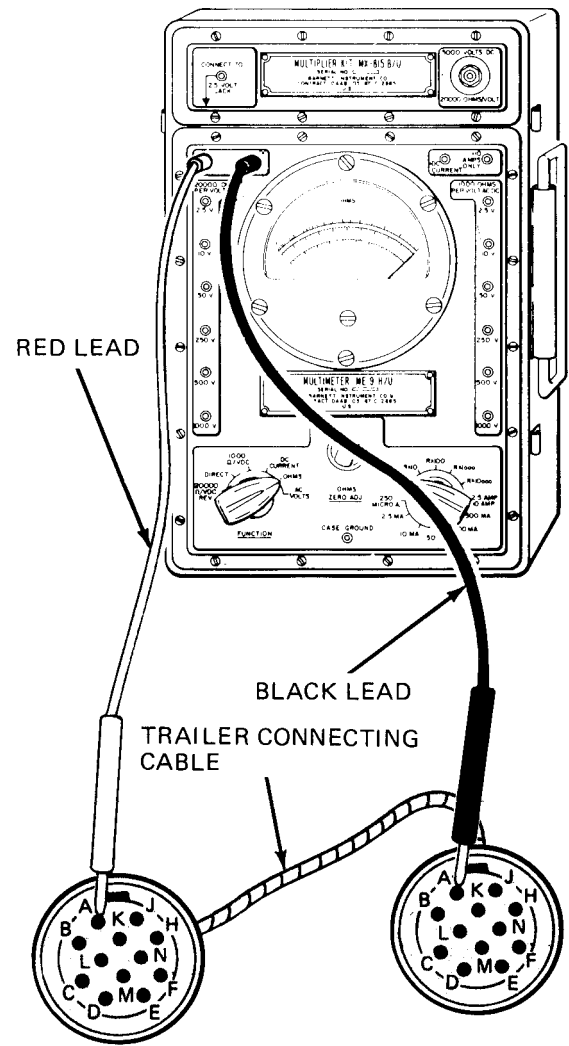
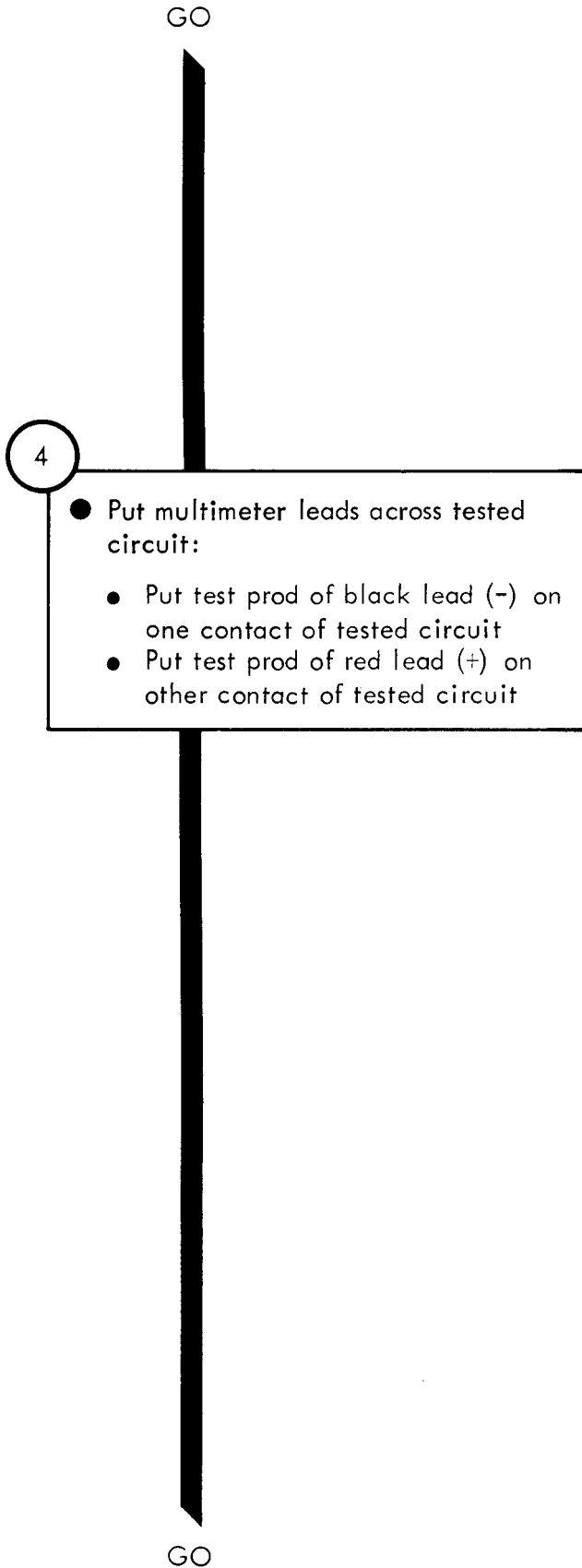

Figure 29-17 (Sheet 4 of 6)



NOTE: MULTIMETER SHOWN CHECKING CONTINUITY OF TRAILER CONNECTING CABLE WIRE ATTACHED TO CONTACT A.

Figure 29-17 (Sheet 5 of 6)

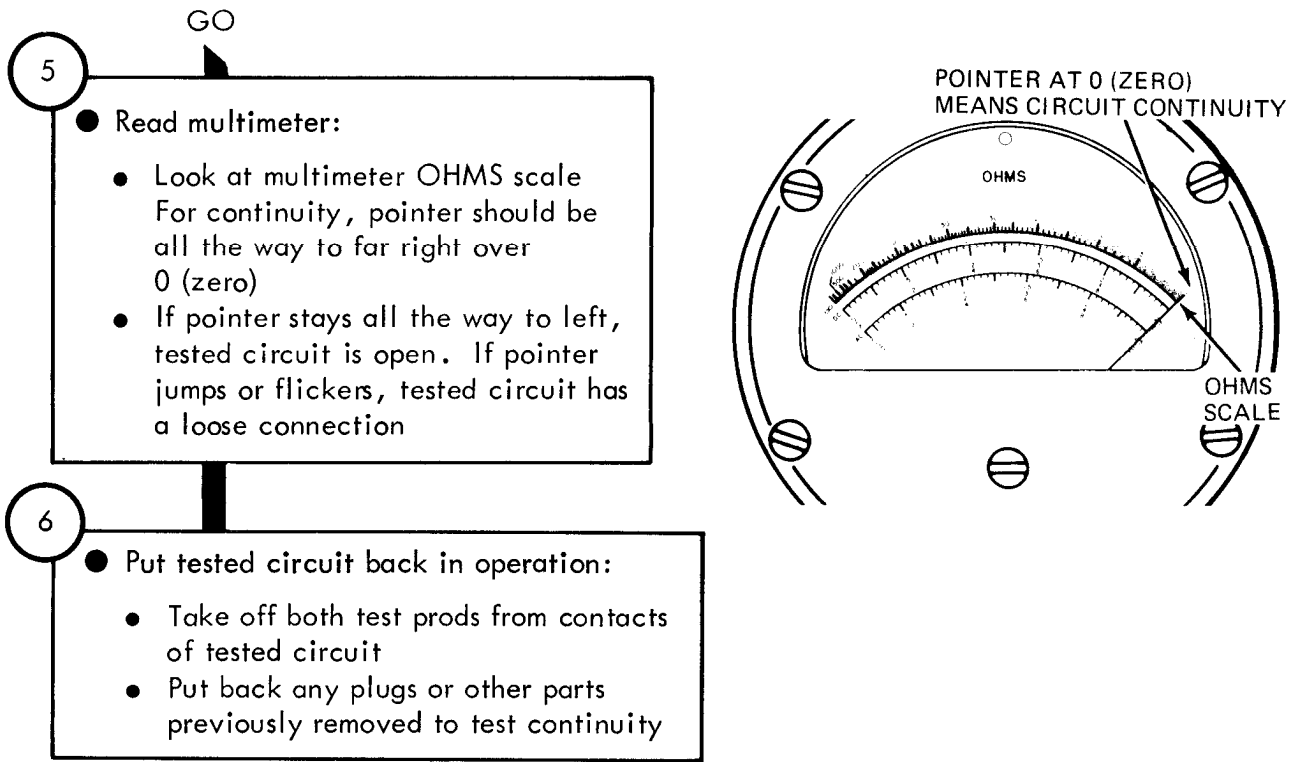
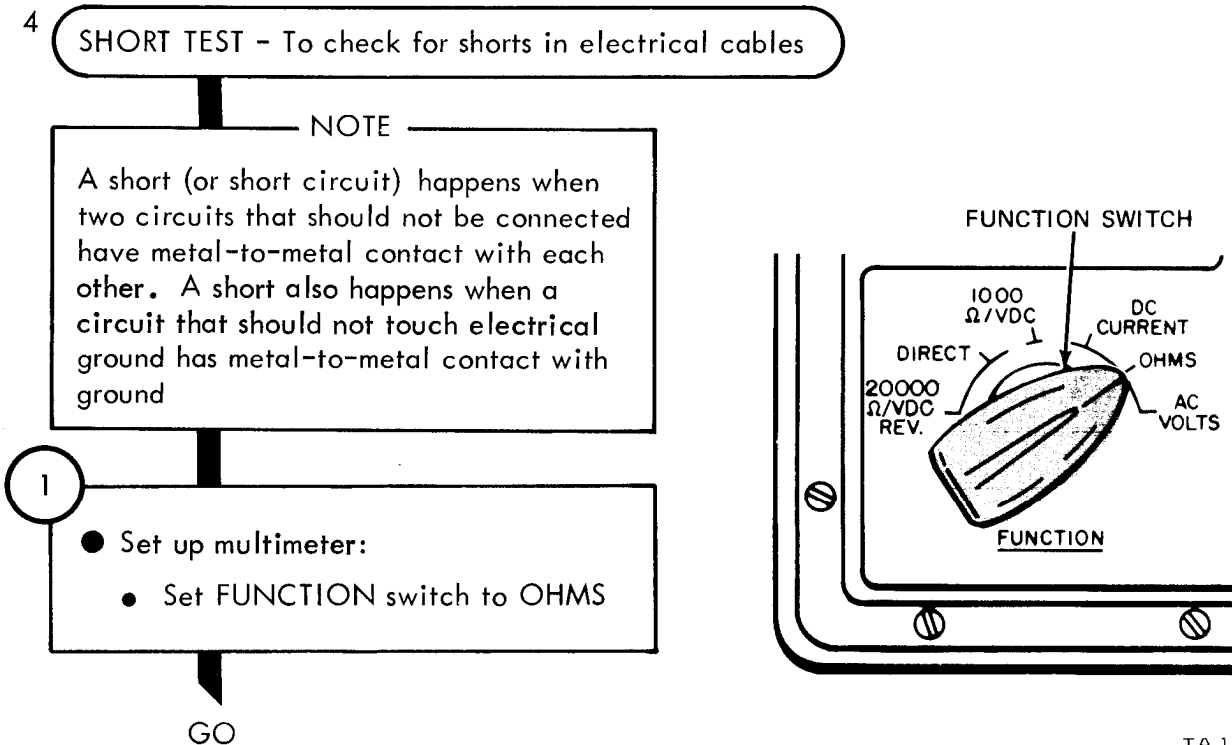

Figure 29-17 (Sheet 6 of 6)



TA 120018

Figure 29-18 (Sheet 1 of 8)

GO

- Set range switch to RX10000

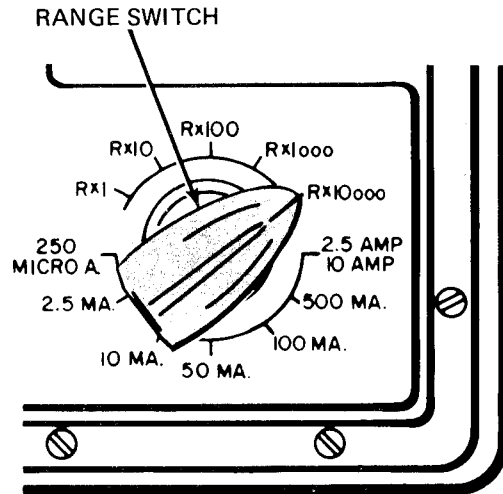

- Put jack plug of black (-) test lead into -DC ±AC OHMS jack
- Put jack plug of red (+) test lead into OHMS jack

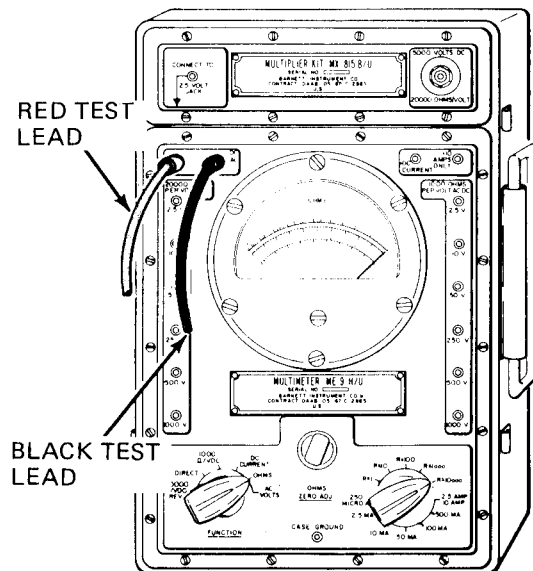

GO

TA 120019

Figure 29-18 (Sheet 2 of 8)

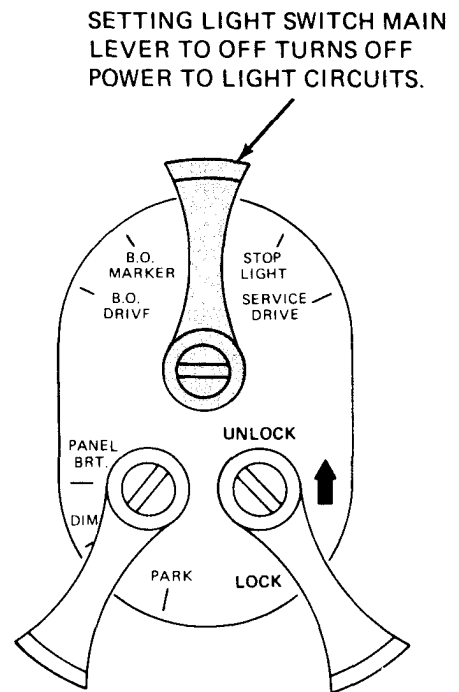
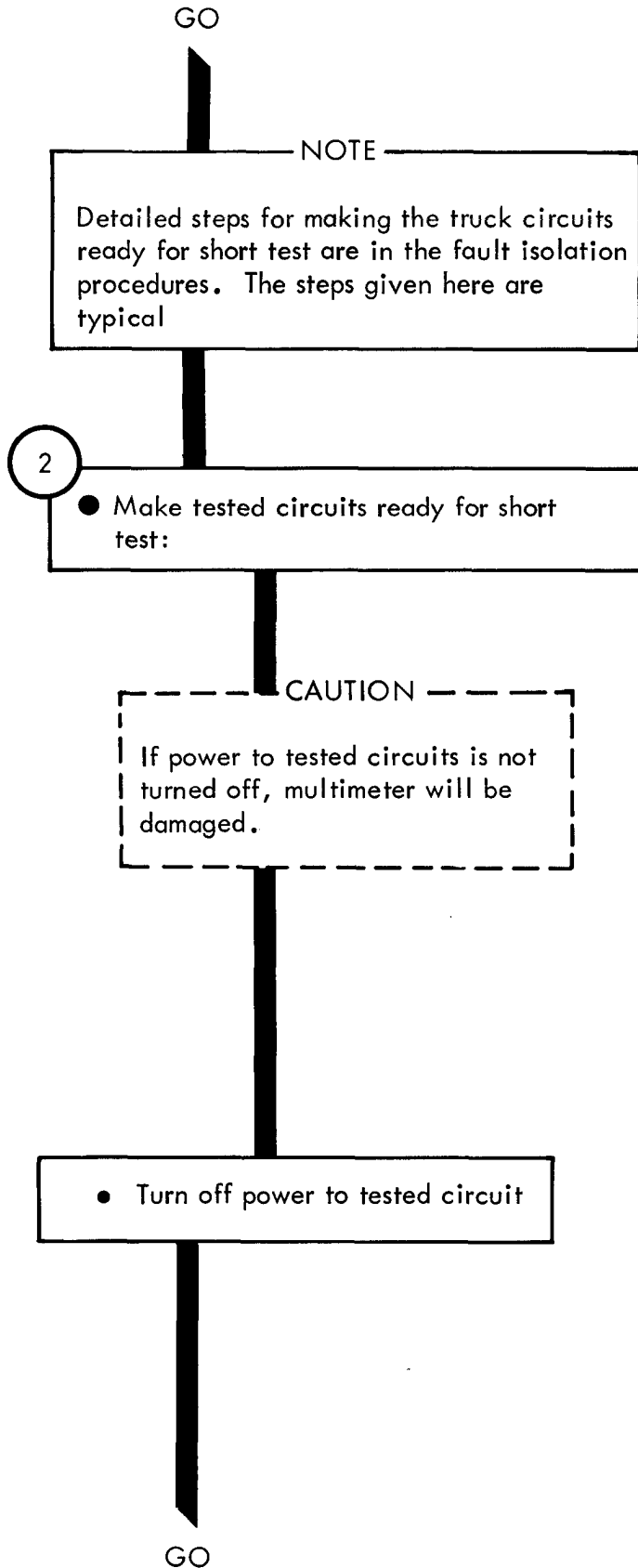

Figure 29-18 (Sheet 3 of 8)

GO

- Take plug on each end of trailer connecting cable off mating receptacle

3

- Zero the multimeter:
 - Touch multimeter test probes together

GO

TAKING CABLE PLUGS OFF MATING RECEPTACLES LETS YOU TEST CABLE WIRES FOR SHORTS

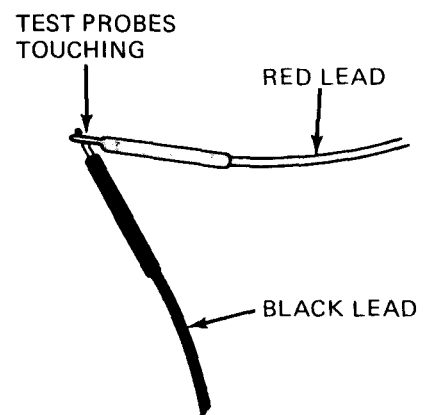
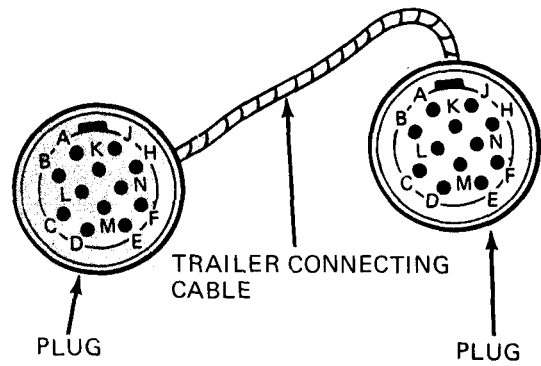

TA 120021

Figure 29-18 (Sheet 4 of 8)

GO

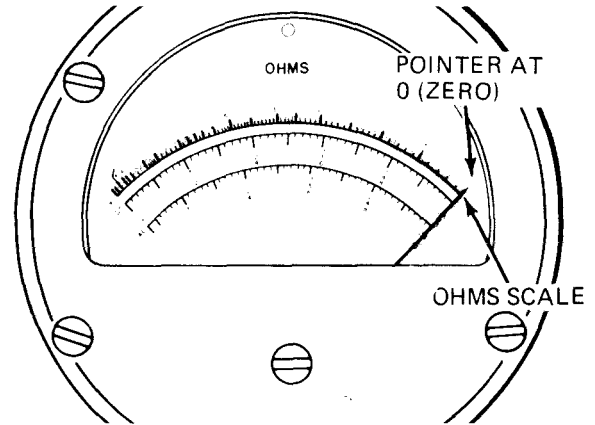

- While touching multimeter test probes together look at OHMS scale. Pointer should be at 0 (zero). If it is not, turn OHMS ZERO ADJ knob to move pointer to 0

GO

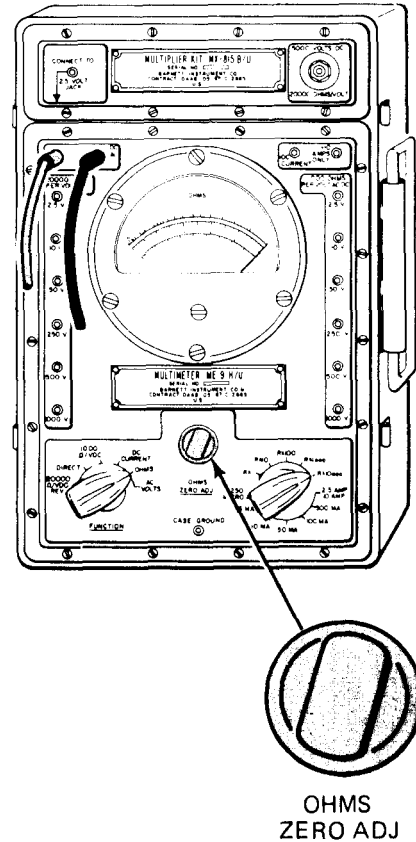

Figure 29-18 (Sheet 5 of 8)

TA 120022

GO

4

- Put multimeter leads across tested circuits:
 - To test for short between two circuits, put test probes on contacts of both circuits

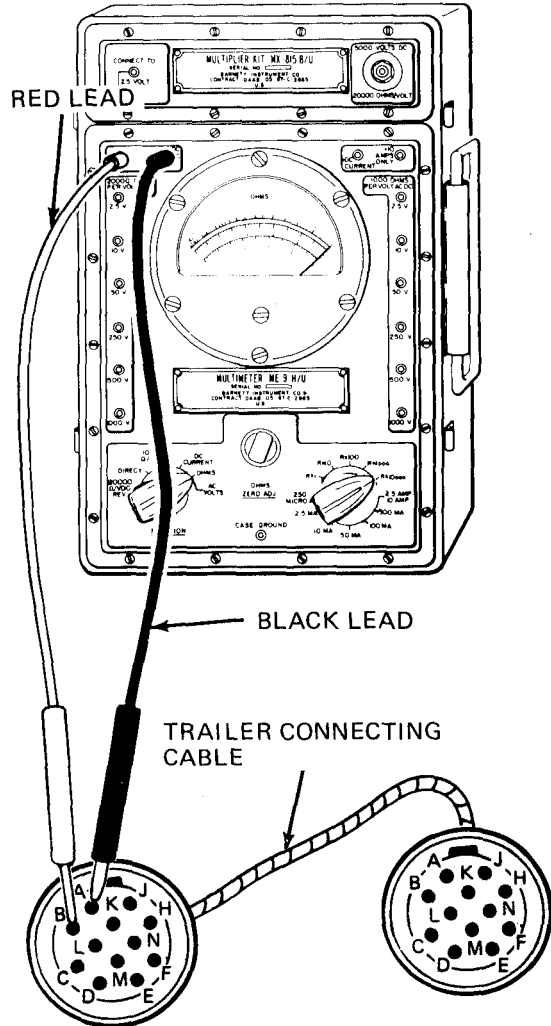

NOTE: MULTIMETER SHOWN CHECKING FOR SHORT BETWEEN TRAILER CONNECTOR CABLE WIRES ATTACHED TO CONTACTS A AND B

GO

Figure 29-18 (Sheet 6 of 8)

GO

- To test for short between a circuit and ground, put one test probe on circuit contact and other test probe on ground

GO

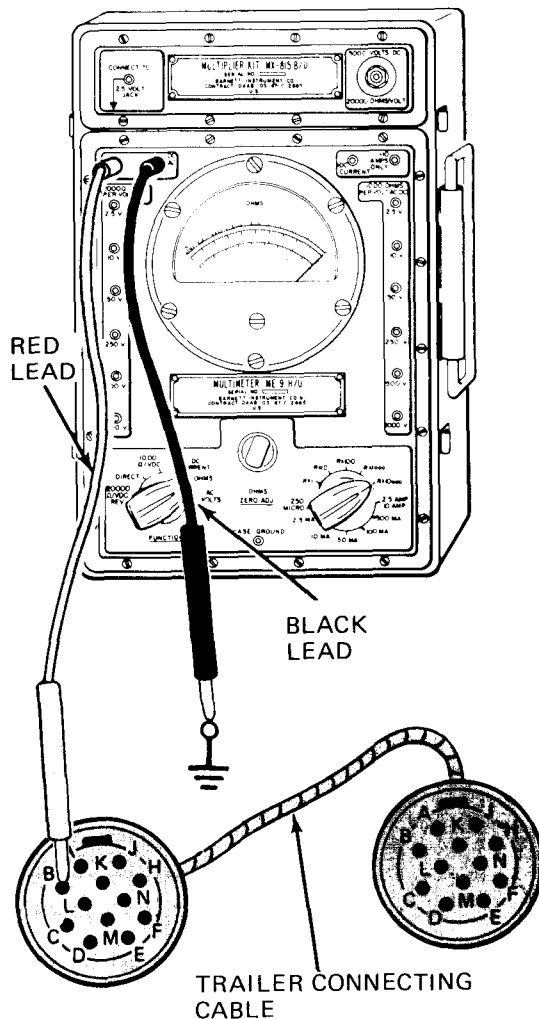

NOTE: MULTIMETER SHOWN CHECKING FOR SHORT BETWEEN TRAILER CONNECTOR CABLE WIRE ATTACHED TO CONTACT B AND GROUND.

Figure 29-18 (Sheet 7 of 8)

GO

5

- Read multimeter:
 - Look at multimeter OHMS scale. If pointer stays all the way to far left without moving, circuits are not shorted
 - If pointer moves all the way to far right over 0 (zero), circuits are shorted. If pointer jumps or flickers, circuits are sometimes shorted

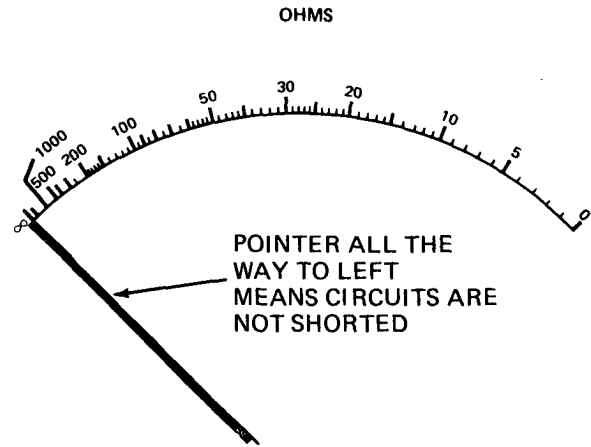

6

- Put tested circuit back in operation
 - Take off both test prods from contacts of tested circuit and from ground
 - Put back any plugs or other parts previously removed to test for shorts

CHAPTER 30

ELECTRICAL SYSTEM OPERATING AND PRELIMINARY PROCEDURES

30-1. EQUIPMENT ITEMS COVERED. This chapter gives equipment operating and preliminary procedures for the system, for which there are authorized corrective maintenance tasks at the organizational maintenance level.

30-2. EQUIPMENT ITEMS NOT COVERED. All equipment items for which corrective maintenance is authorized at the organizational maintenance level are covered in this chapter.

TROUBLESHOOTING

GENERAL INFORMATION

NOTE

When making light switch main lever selections from OFF to any ON position except B. O. MARKER, unlock switch must be lifted to UNLOCK position

The condition of the batteries should always be checked before troubleshooting any system in the truck

The truck has two 12 volt DC batteries connected in series, to furnish 24 volts DC to the electrical system which uses a negative (-) ground and positive (+) power feed to the electrical components

To test the condition of batteries, set BATTERY SWITCH to ON. (Do not start engine)

The battery indicator should be in position as shown in view A

Start engine and run at 1200 RPM. See view B

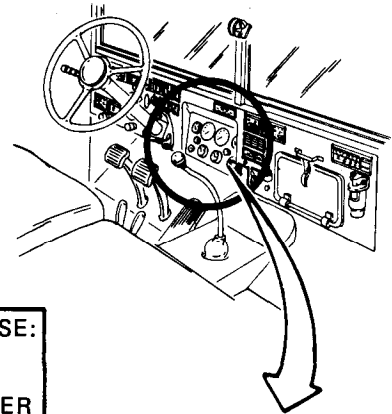

VIEW B

BATTERY IN USE:
CHARGING OR
UNDER STARTER
LOAD.

READINGS HERE
INDICATE THAT
BATTERY IS
NEARLY WORN
OUT.

ENGINE RUNNING
AT NORMAL SPEED
FOR SEVERAL
MINUTES, AND
POINTER RESTS
HERE, MEANS
BATTERY IS NOT
CHARGING.
CHECK VOLTAGE
REGULATOR. IF
OK, CHECK
GENERATOR.

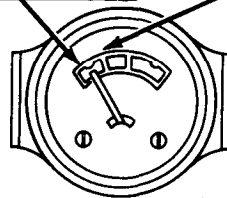

ENGINE RUNNING
AT MAXIMUM
CHARGING SPEED
LONG ENOUGH TO
CHARGE BATTERY,
WITH ALL ELECTRICAL
UNITS TURNED ON,
POINTER SHOULD
STAY IN GREEN
SECTION. IF NOT,
VOLTAGE
REGULATOR IS SET
TOO LOW, OR
BATTERY IS
WORN OUT.

BATTERY
AT REST:
READINGS HERE
INDICATE A DEAD
BATTERY. COULD BE
UNDERCHARGING
OR A SHORT IN
ELECTRICAL SYSTEM.
IF NEEDLE REMAINS
HERE, BATTERY IS
WORN OUT OR
DEFECTIVE.

VIEW A

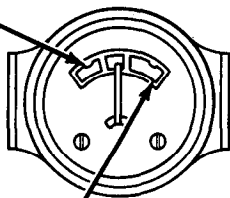

WITH ALL
ELECTRICAL UNITS
OFF, RUN ENGINE
TO MAXIMUM
CHARGING RATE.
IF VOLTAGE
REGULATOR IS
PROPERLY SET,
POINTER WILL FALL
IN TOP HALF OF
GREEN SECTION.

READINGS HERE SHOW
BATTERY WAS RECENTLY
CHARGED AT HIGH RATE
(OVERCHARGED)

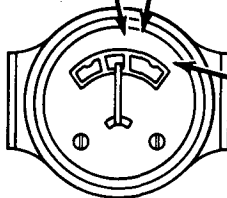

OVERCHARGE
SECTION
MALADJUSTED
OR DEFECTIVE
VOLTAGE
REGULATOR.

Figure 30-1

TA 116091

CHAPTER 31

ELECTRICAL SYSTEM CHECKOUT PROCEDURES

31-1. GENERAL. This chapter gives procedures for checking out the system after troubleshooting and repair have been done. Procedures are set up in flow chart form showing the checkout steps in order and referring to the fault symptom index when the system does not check out.

INDICATOR GAGE SUBSYSTEM CHECKOUT

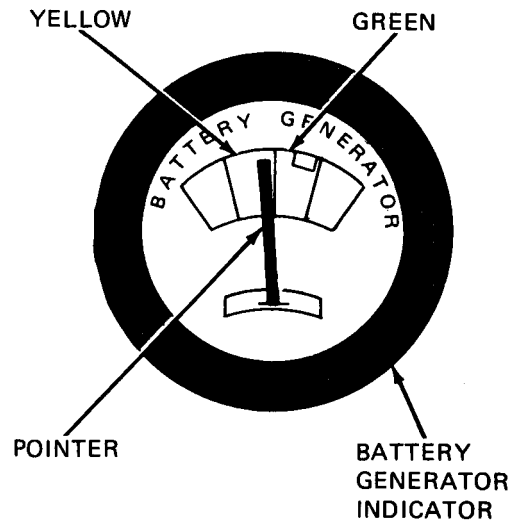
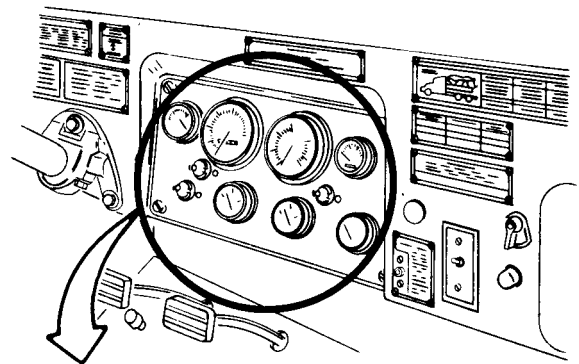
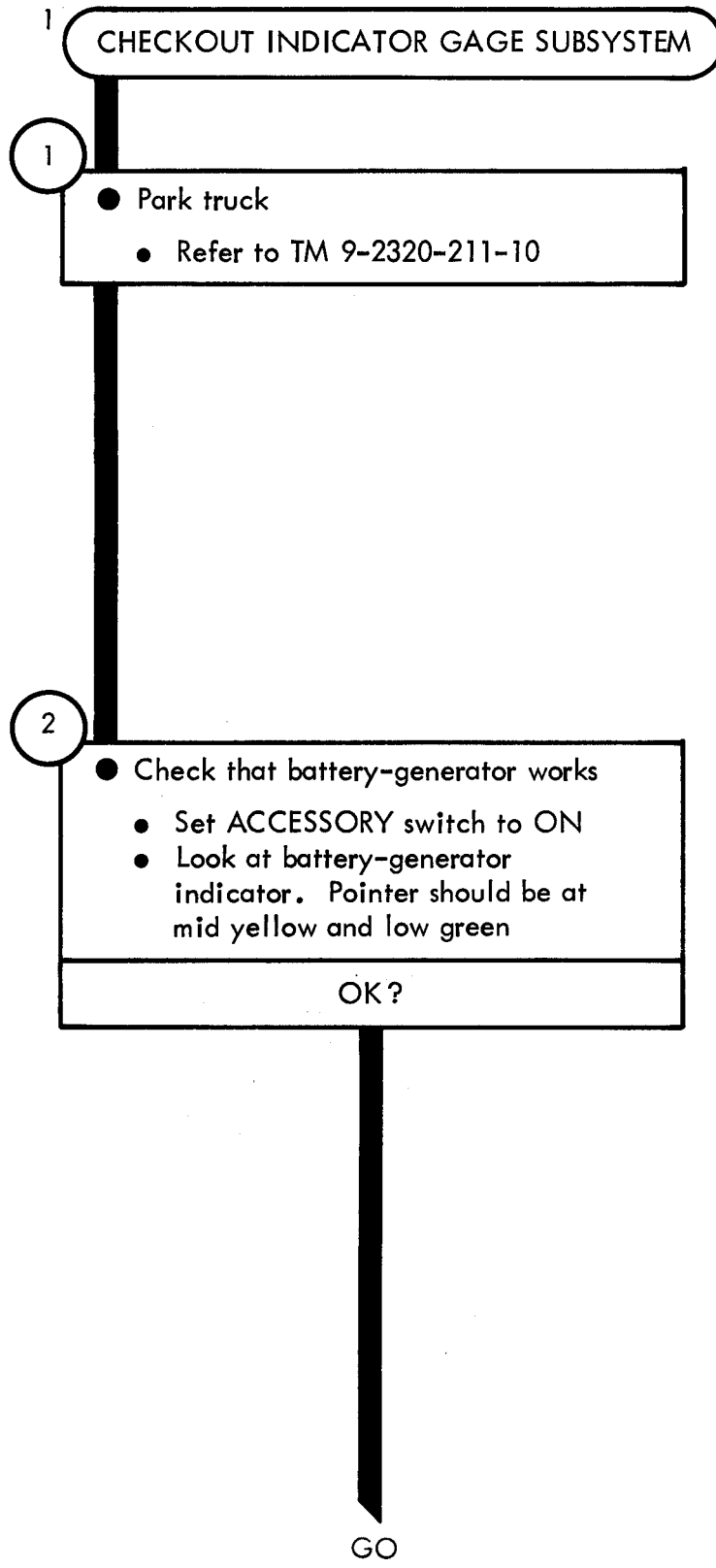

Figure 31-1 (Sheet 1 of 6)

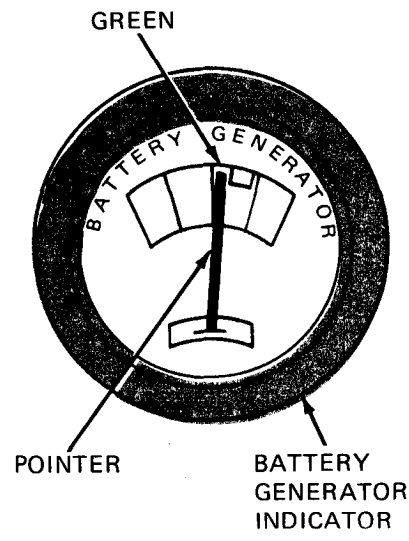
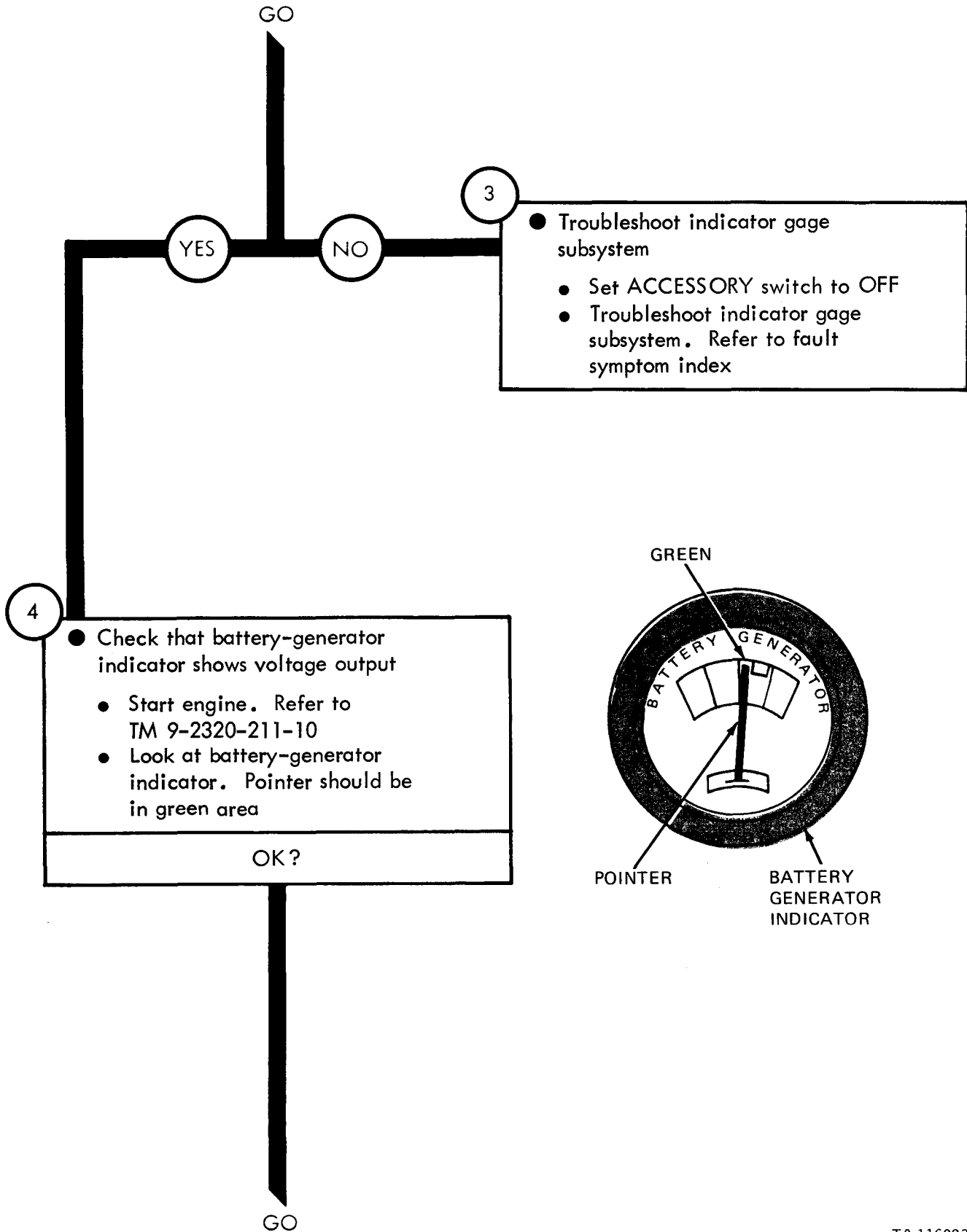

Figure 31-1 (Sheet 2 of 6)

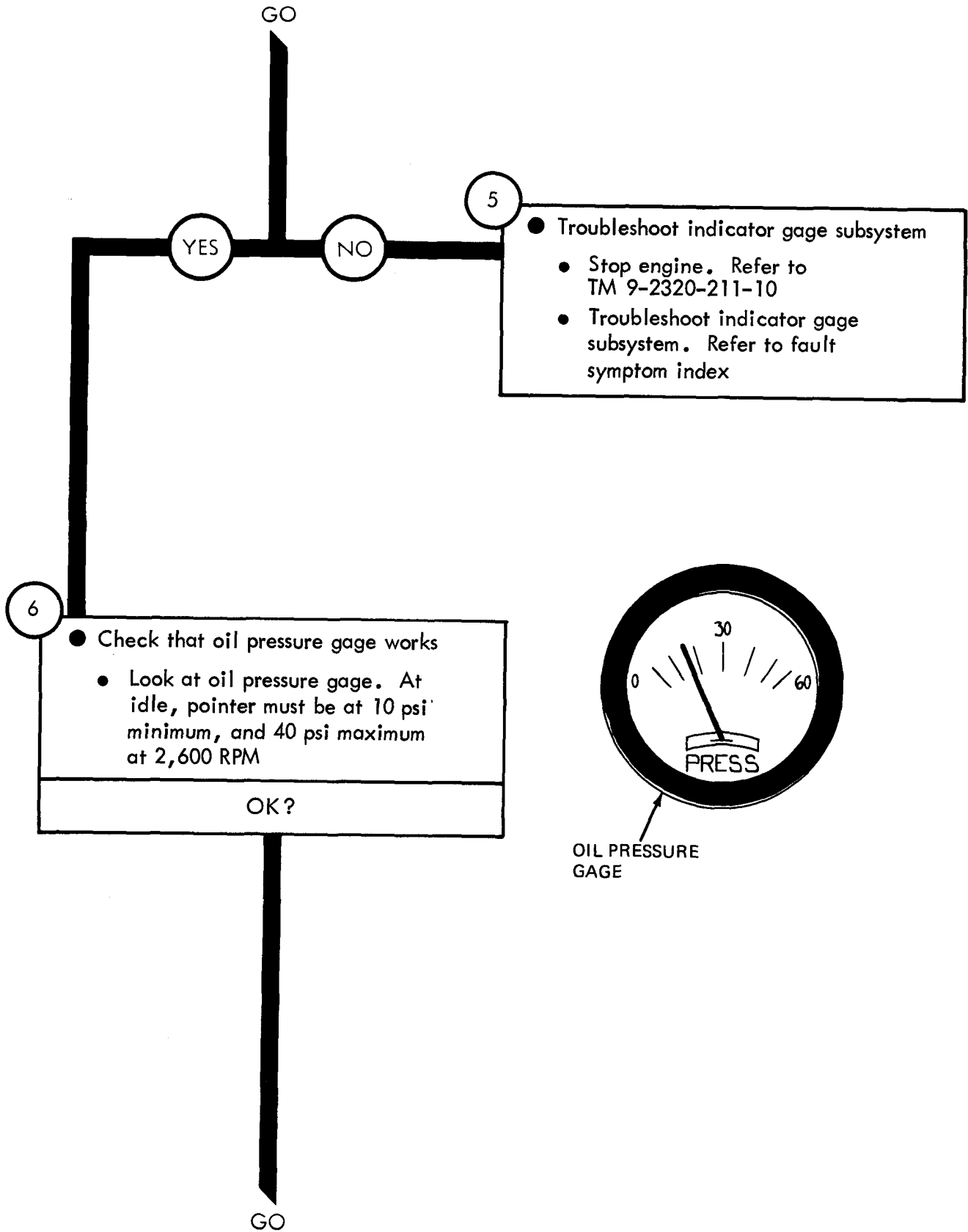

Figure 31-1 (Sheet 3 of 6)

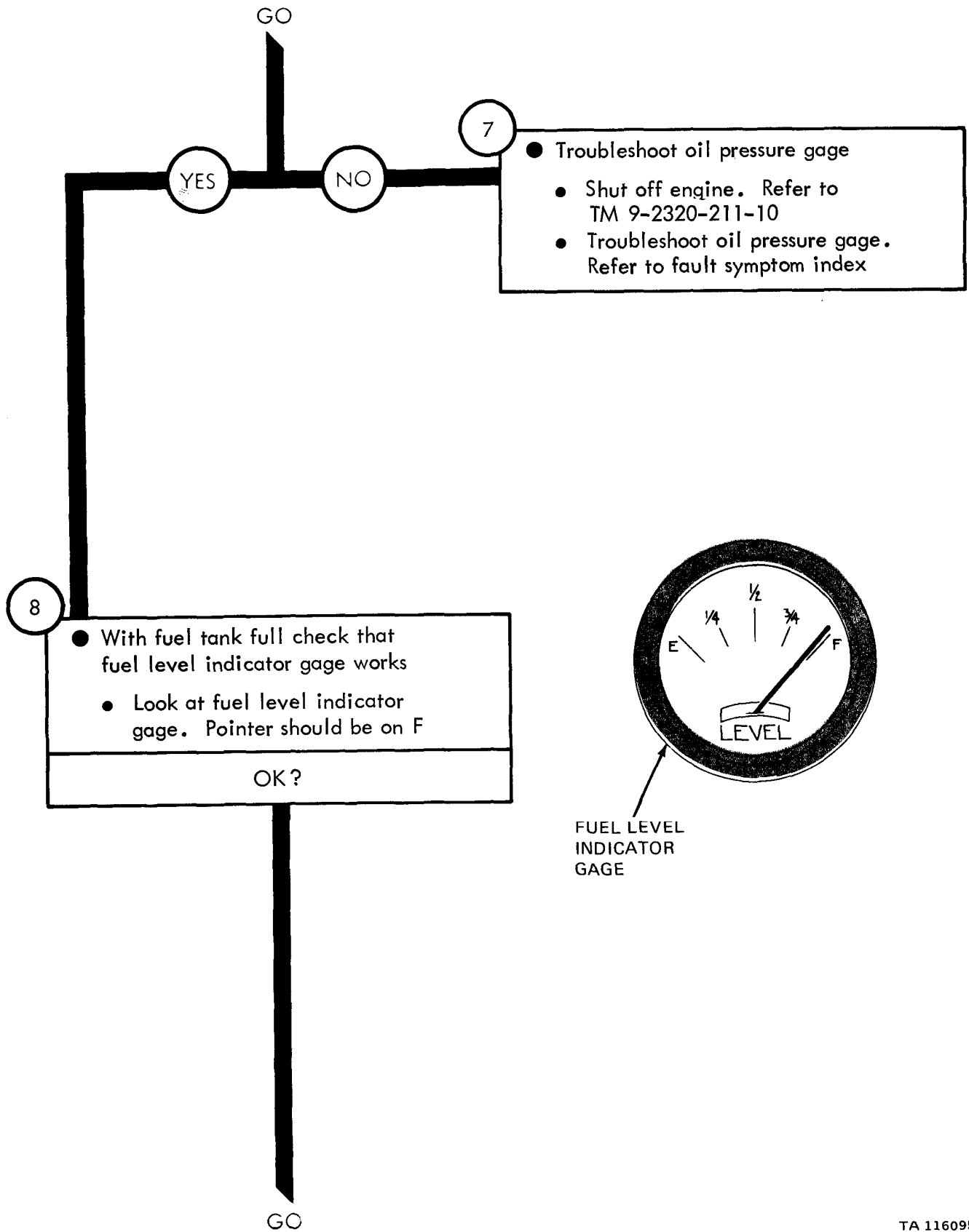

Figure 31-1 (Sheet 4 of 6)

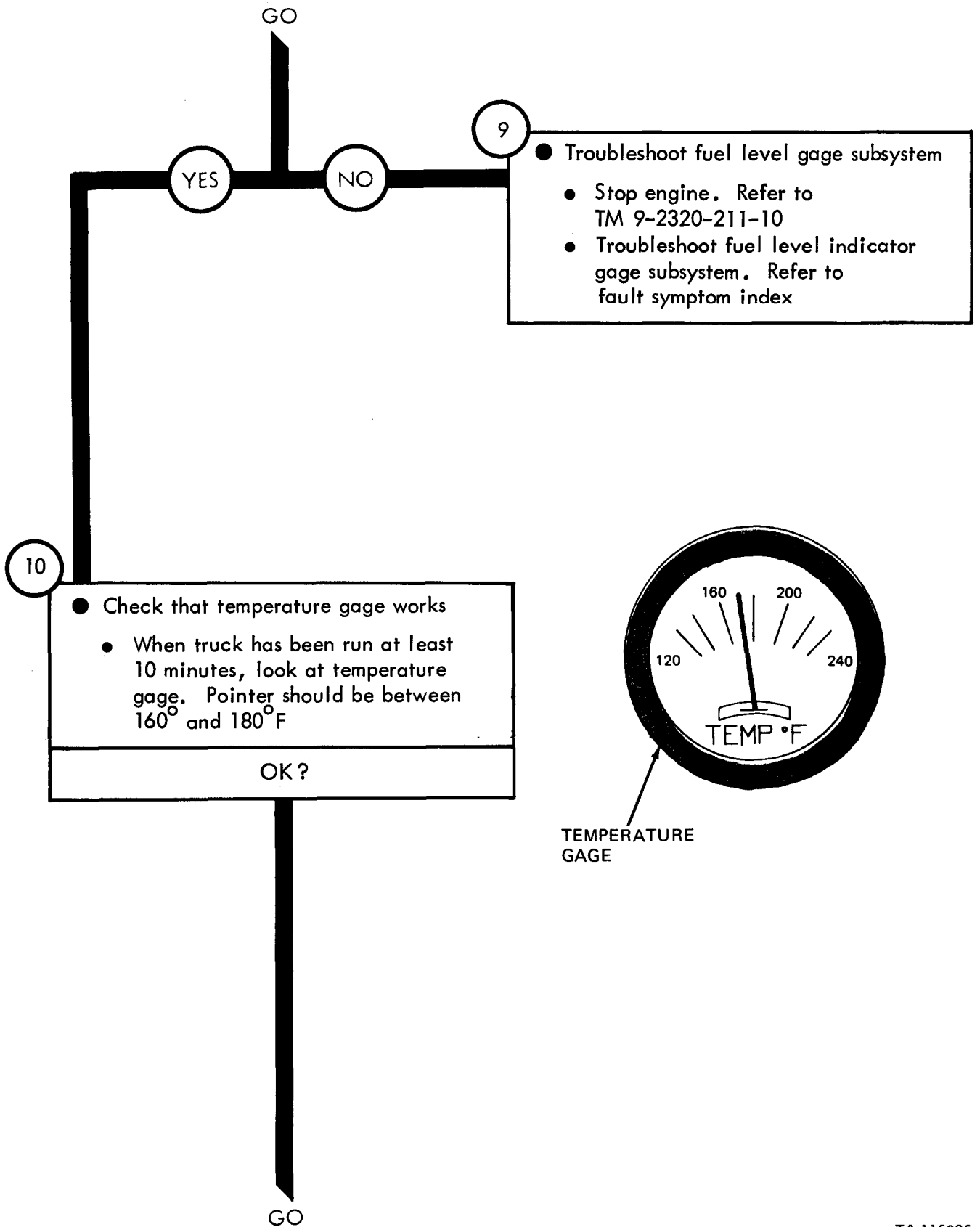

Figure 31-1 (Sheet 5 of 6)

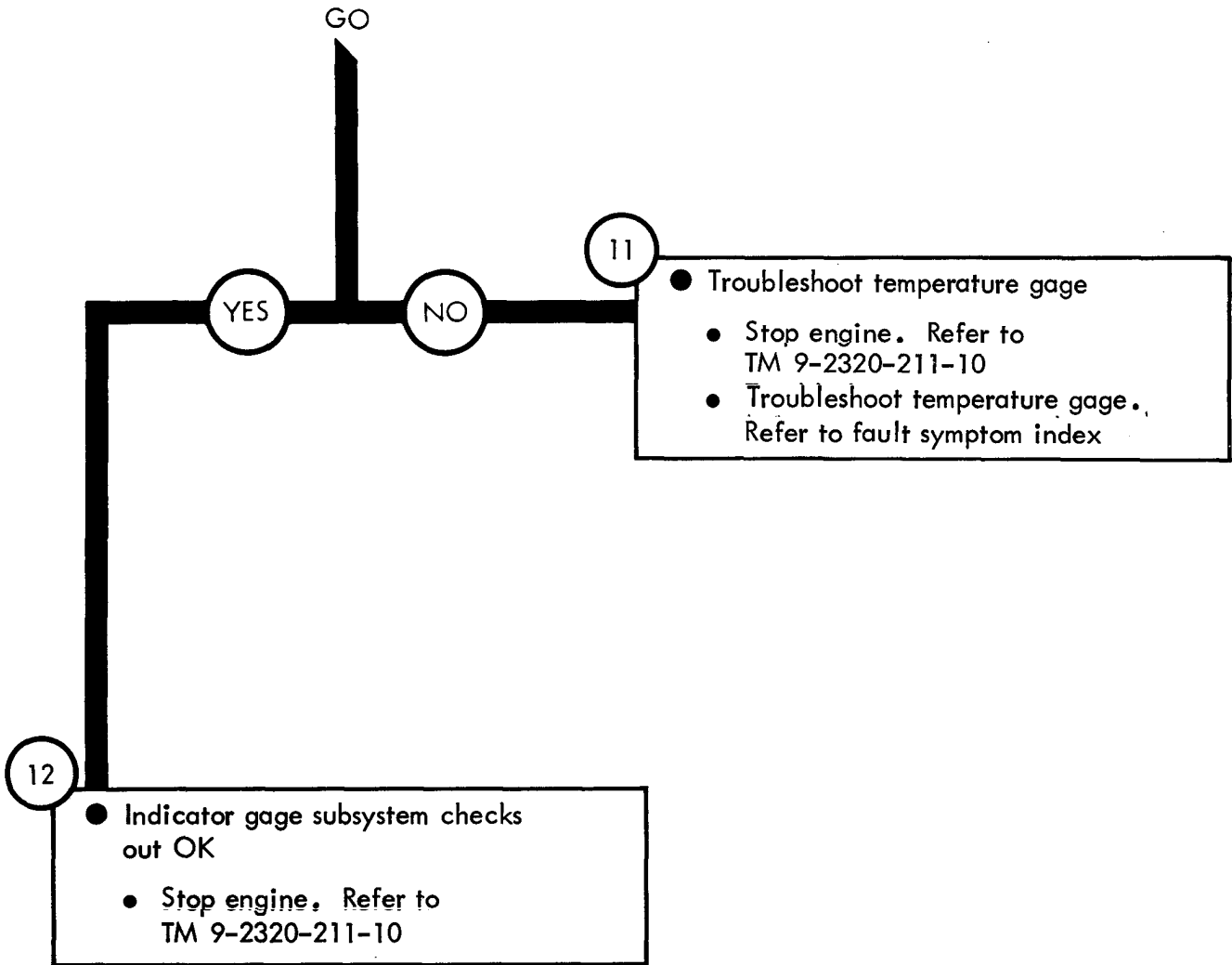

Figure 31-1 (Sheet 6 of 6)

CHECKOUT LIGHTING SUBSYSTEM

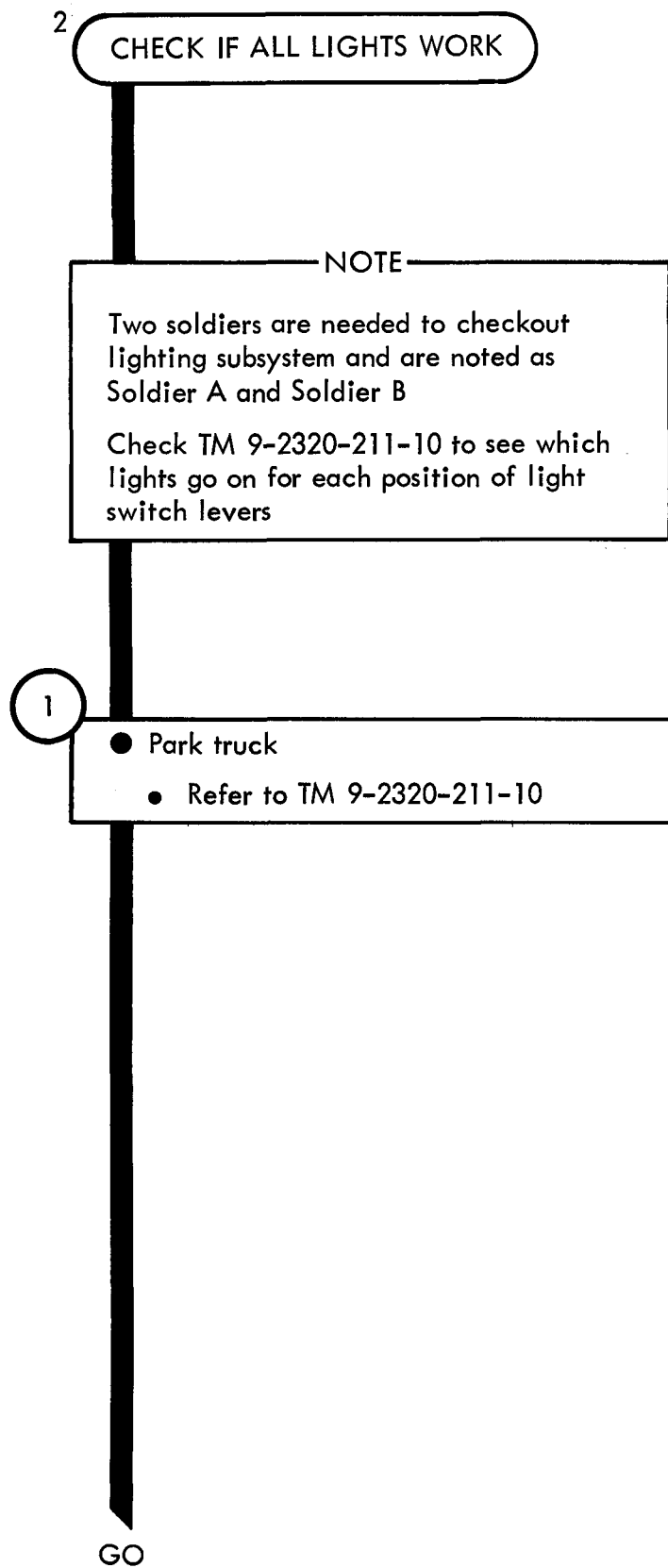

Figure 31-2 (Sheet 1 of 2)

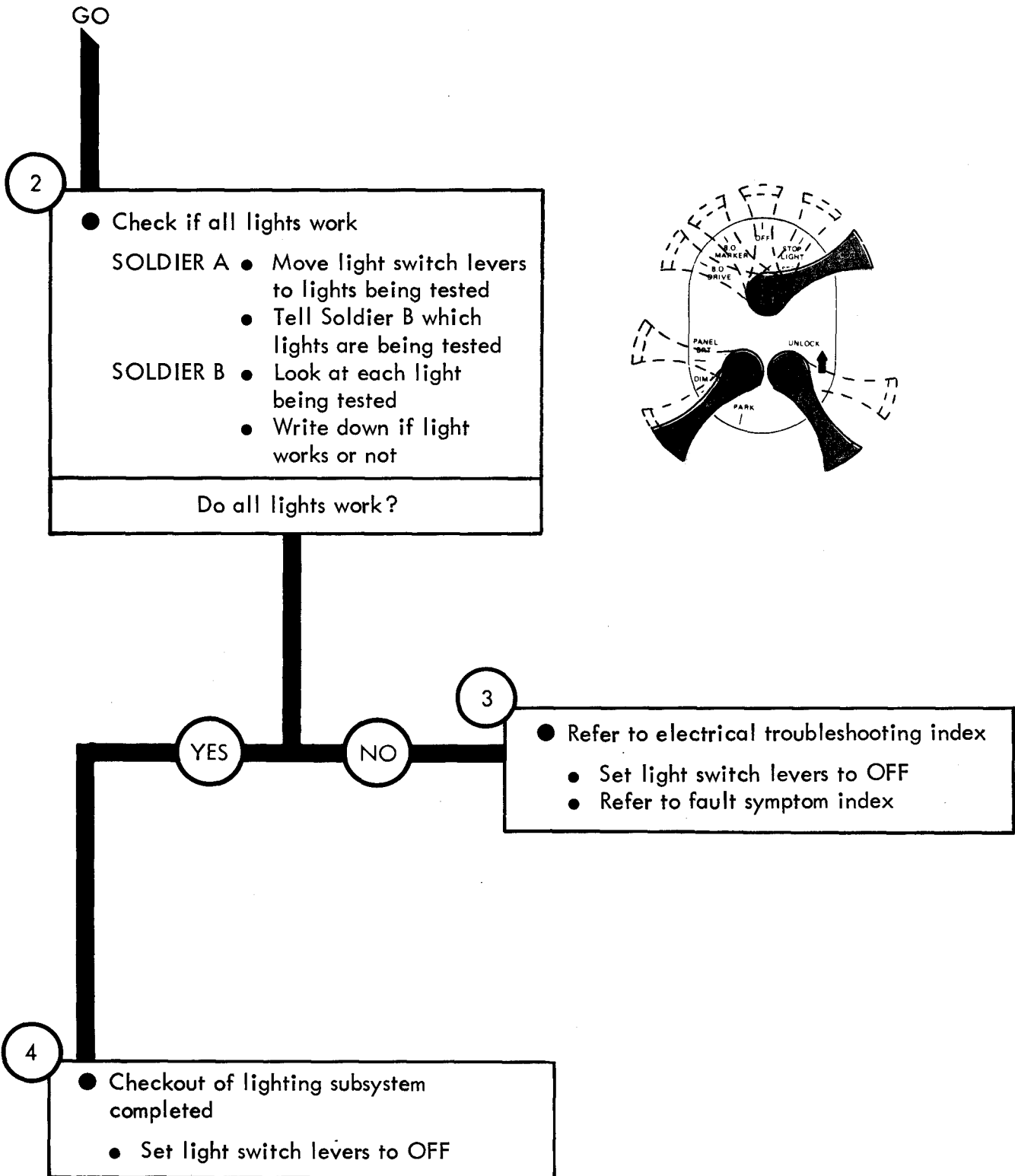

Figure 31-2 (Sheet 2 of 2)

DIRECTIONAL SIGNAL SUBSYSTEM CHECKOUT

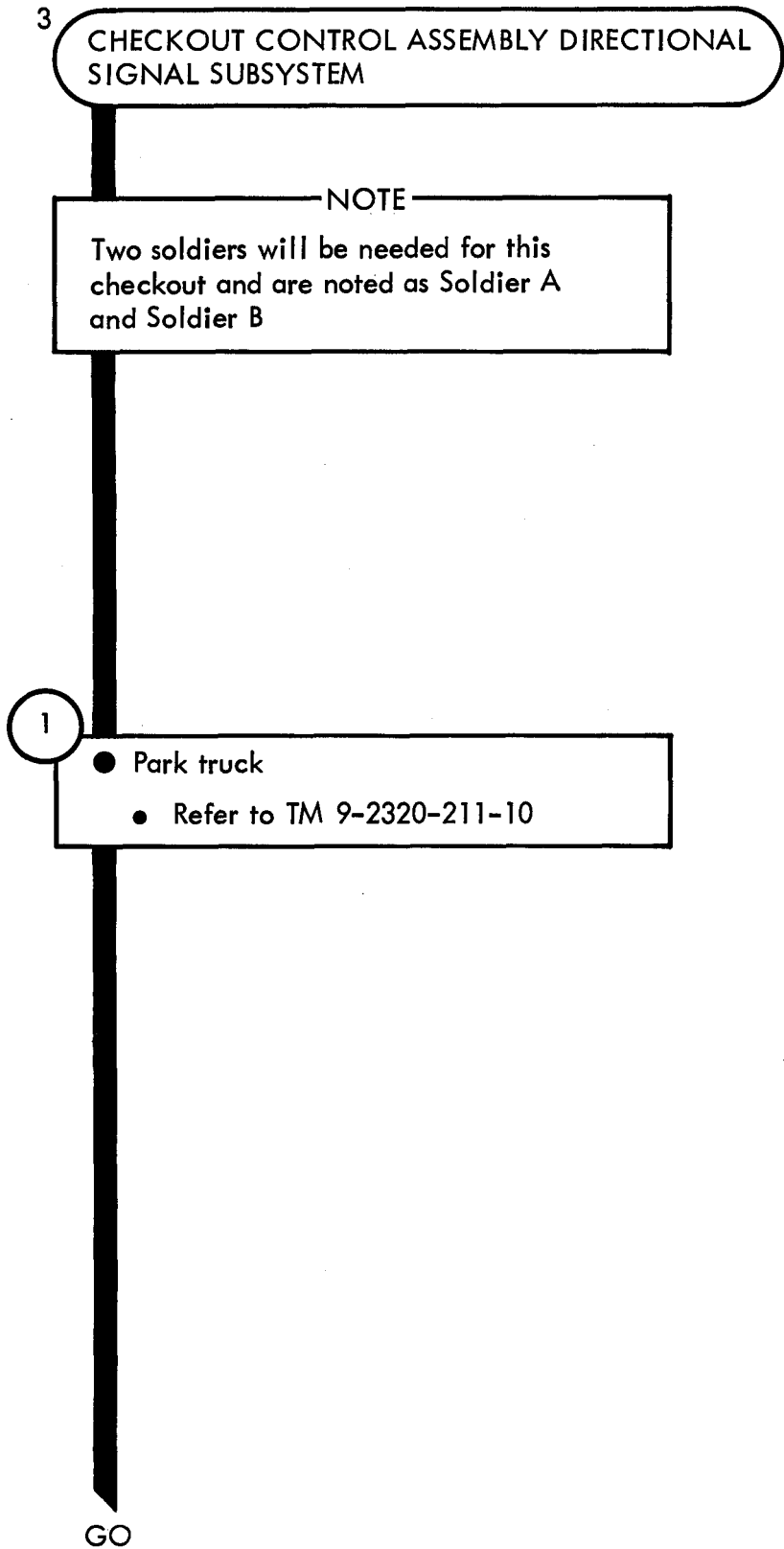

Figure 31-3 (Sheet 1 of 4)

TA 116100

GO

2

- Check that hazard warning lights work
- SOLDIER A ● Set IGNITION switch to ON
- Set light switch main lever to SERVICE DRIVE
 - Set turn signal control arm to hazard warning position
 - Check that turn signal control lamp flashes 1 to 2 times per second

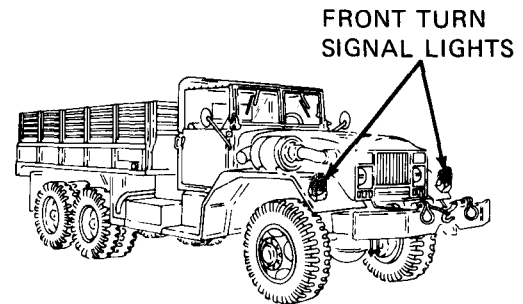

REAR TURN SIGNAL LIGHTS

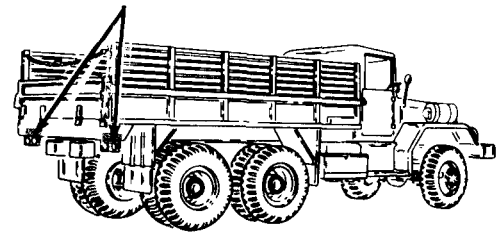

- SOLDIER B ● Check that two front signal lamps and two rear signal lamps flash together at 1 to 2 times per second
- SOLDIER A ● Step on brake pedal and hold it down
- Check that turn signal control arm lamp flashes 1 to 2 times per second
- SOLDIER B ● While Soldier A holds down brake pedal check that rear turn signal lamps flash 1 to 2 times per second

TURN SIGNAL CONTROL ARM

IGNITION SWITCH

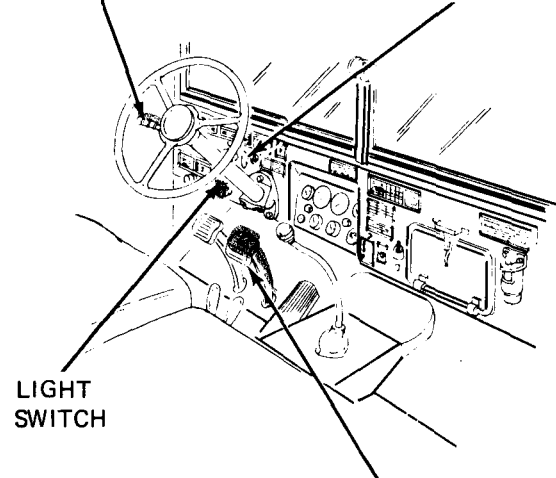

Do hazard warning lamps check out OK?

GO

Figure 31-3 (Sheet 2 of 4)

TA 116101

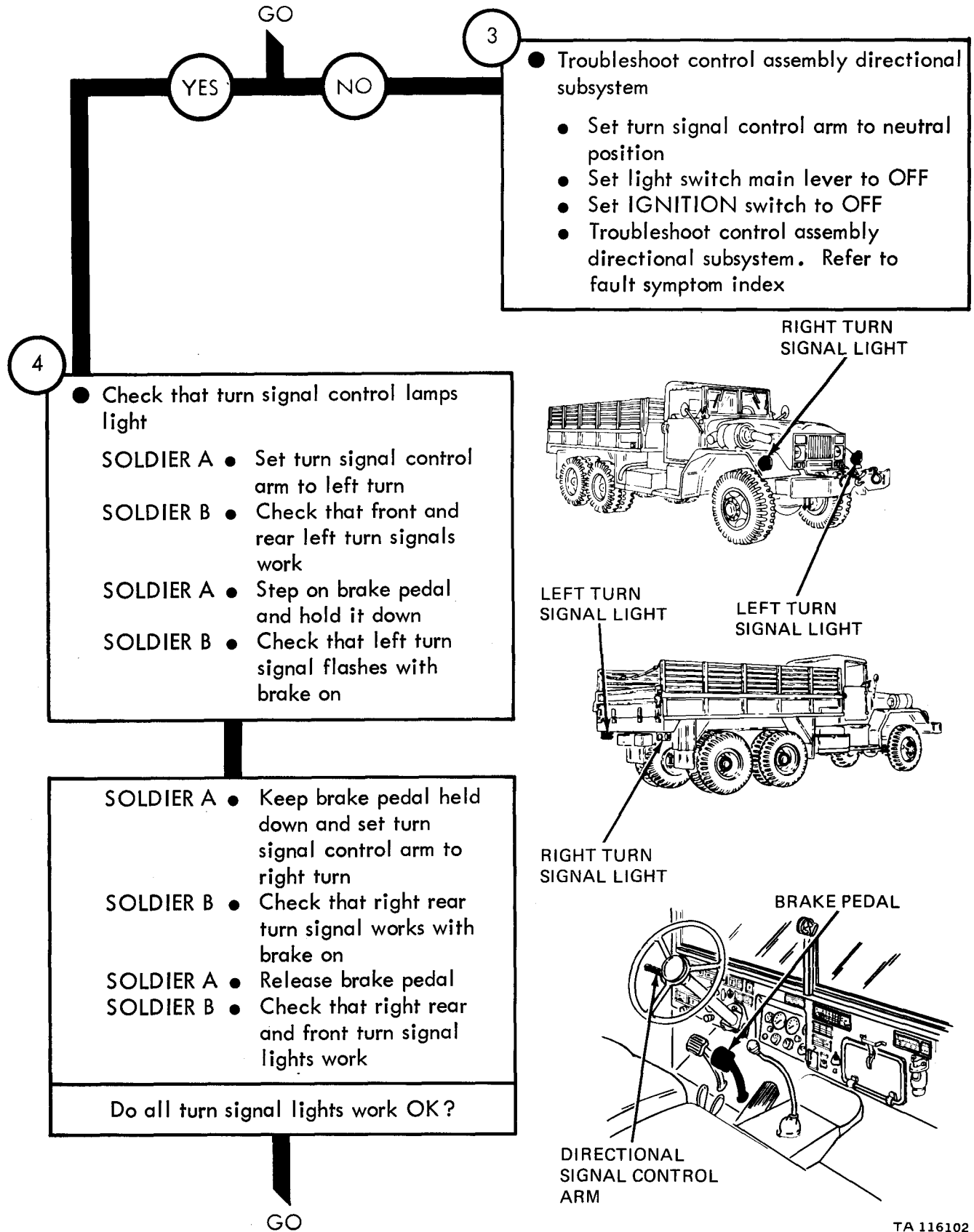

TA 116102

Figure 31-3 (Sheet 3 of 4)

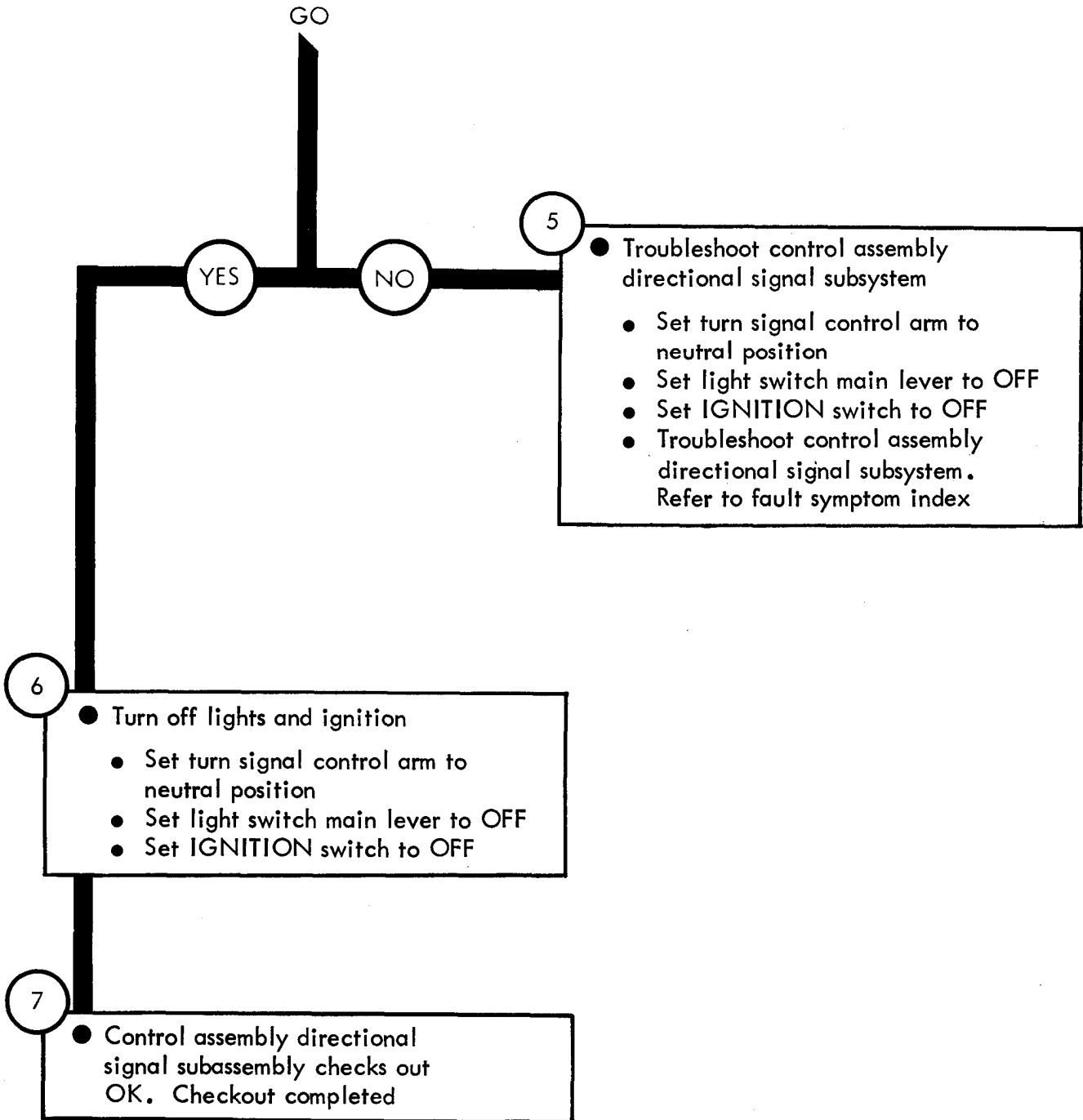

Figure 31-3 (Sheet 4 of 4)

CHAPTER 32

TRANSMISSION SYSTEM TROUBLESHOOTING

32-1. EQUIPMENT ITEMS COVERED. This chapter gives equipment troubleshooting procedures for the transmission system, for which there are authorized corrective maintenance tasks at the organizational maintenance level.

32-2. EQUIPMENT ITEMS NOT COVERED. All equipment items for which corrective maintenance is authorized at the organizational maintenance level are covered in this chapter.

TRANSMISSION SYSTEM TROUBLESHOOTING

Symptom

1 TRANSMISSION LEAKS OIL

- 1
- Park truck
 - Refer to TM 9-2320-211-10

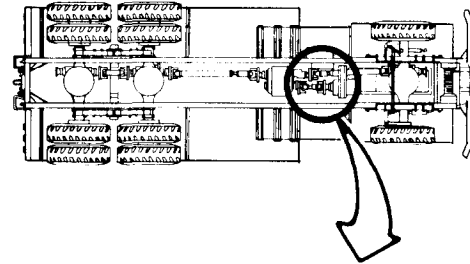

- 2
- Check transmission casing
 - Crawl under truck
 - Look for a cracked or broken casing
- Is transmission casing OK?

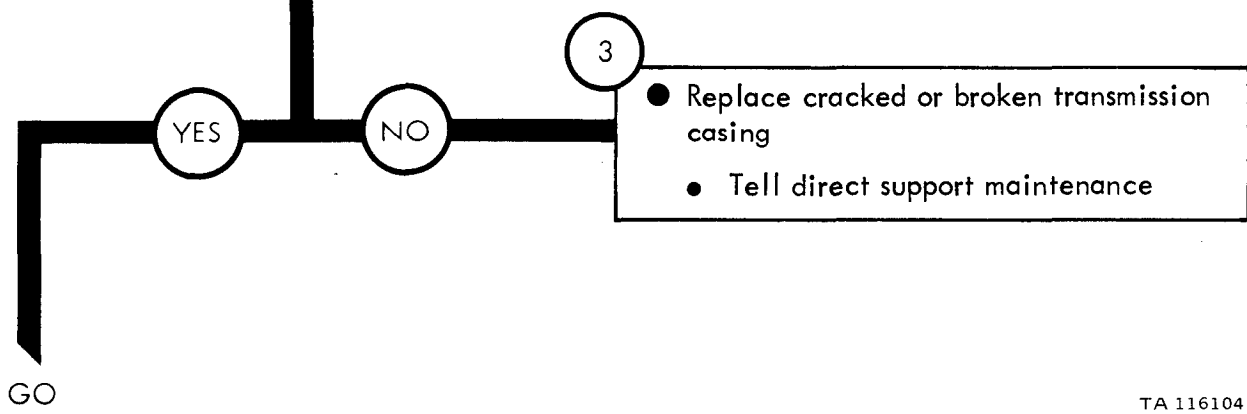
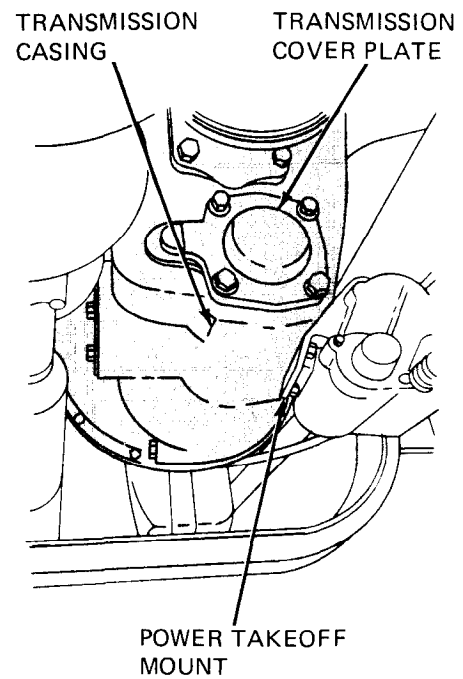

Figure 32-1 (Sheet 1 of 3)

TA 116104

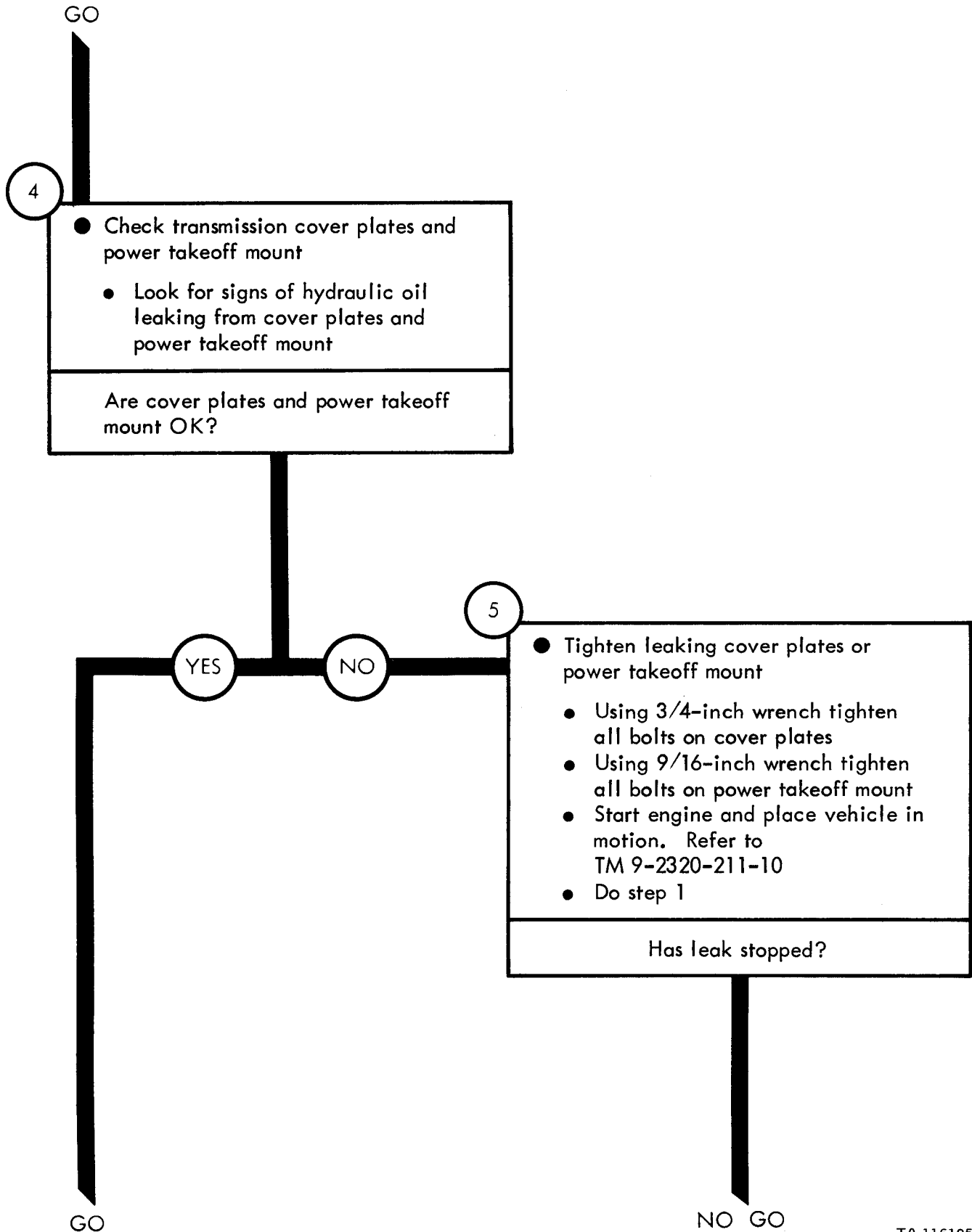

Figure 32-1 (Sheet 2 of 3)

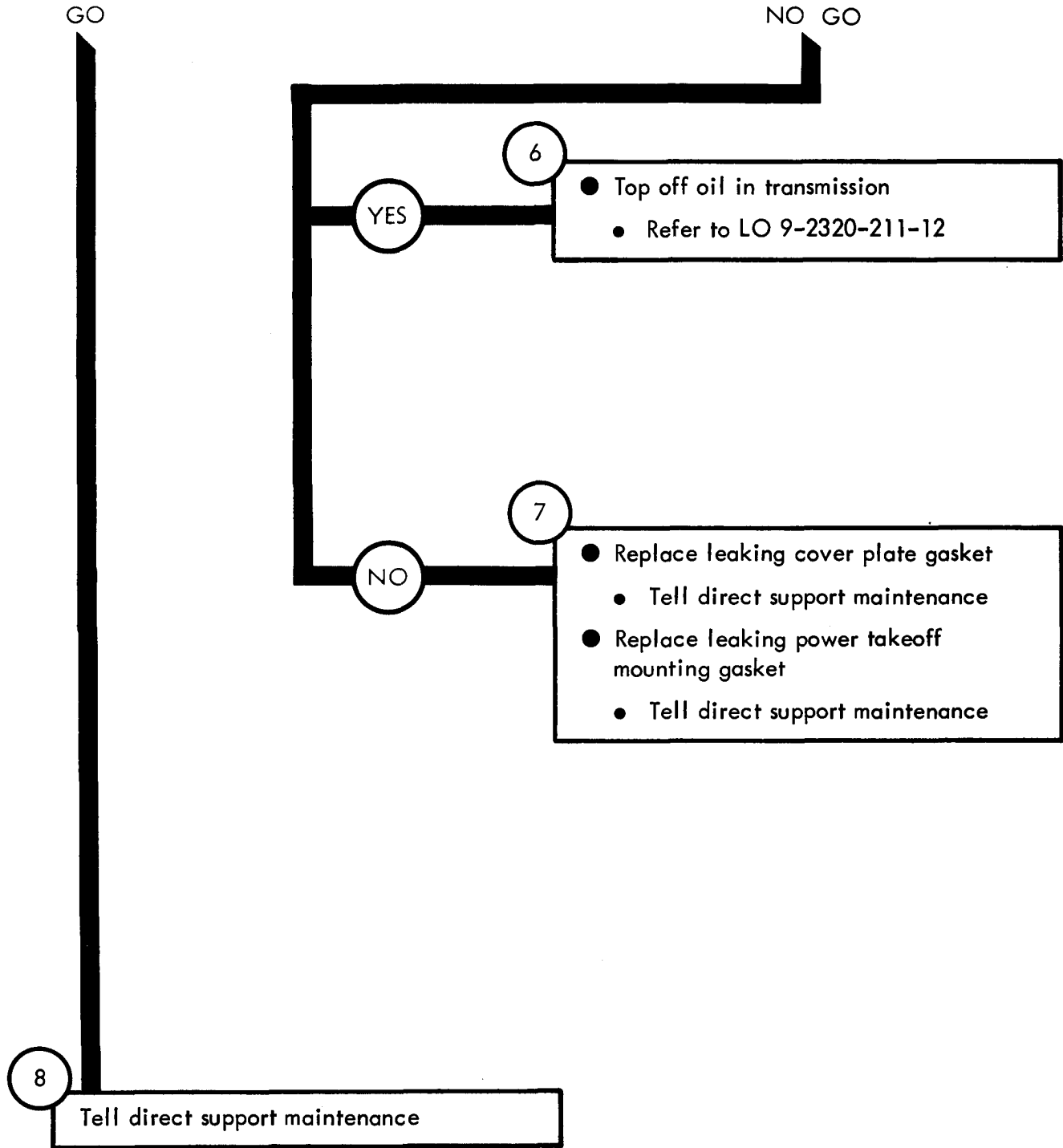

Figure 32-1 (Sheet 3 of 3)

Symptom

2

TRANSMISSION GEARS GRIND WHEN SHIFTING

1

- Park truck
- Refer to procedures given in TM 9-2320-211-10

NOTE

Clutch system is not part of transmission system. However parts in clutch system can cause the transmission gears to grind when shifting

2

- Check clutch linkage
- Look for bent or broken linkage

Is clutch linkage OK?

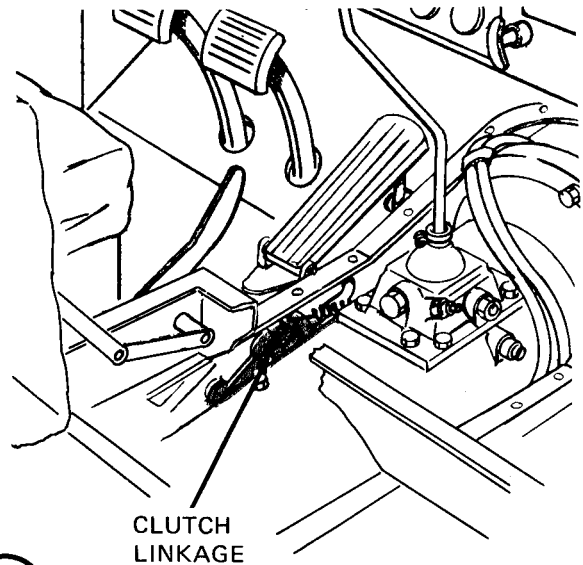

3

- Replace bent or broken linkage
- Refer to Vol 3, chapter 3, para 3-4

4

- Replace transmission
- Tell direct support maintenance

NO

NO

TA 116107

Figure 32-2

CHAPTER 33

TRANSFER SYSTEM TROUBLESHOOTING

33-1. EQUIPMENT ITEMS COVERED . This chapter gives equipment troubleshooting procedures for the transfer system, for which there are authorized corrective maintenance tasks at the organizational maintenance level.

33-2. EQUIPMENT ITEMS NOT COVERED . All equipment items for which corrective maintenance is authorized at the organizational maintenance level are covered in this chapter.

Symptom

1

TRANSFER LEAKS OIL

1

- Make truck ready for work on transfer
 - Park truck. Refer to TM 9-2320-211-10
 - Chock wheels
 - Crawl under truck

2

- Check transfer gaskets and seals
 - Look for signs of gear oil leaking from gaskets
 - Look at propeller shaft flanges to see if gear oil is leaking from seals

Are gaskets and seals OK?

GO

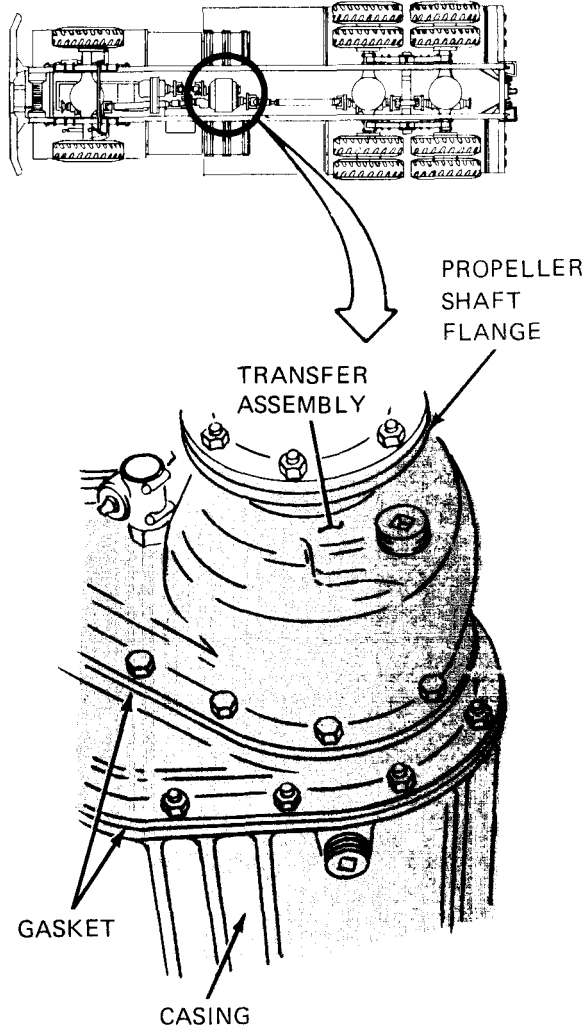
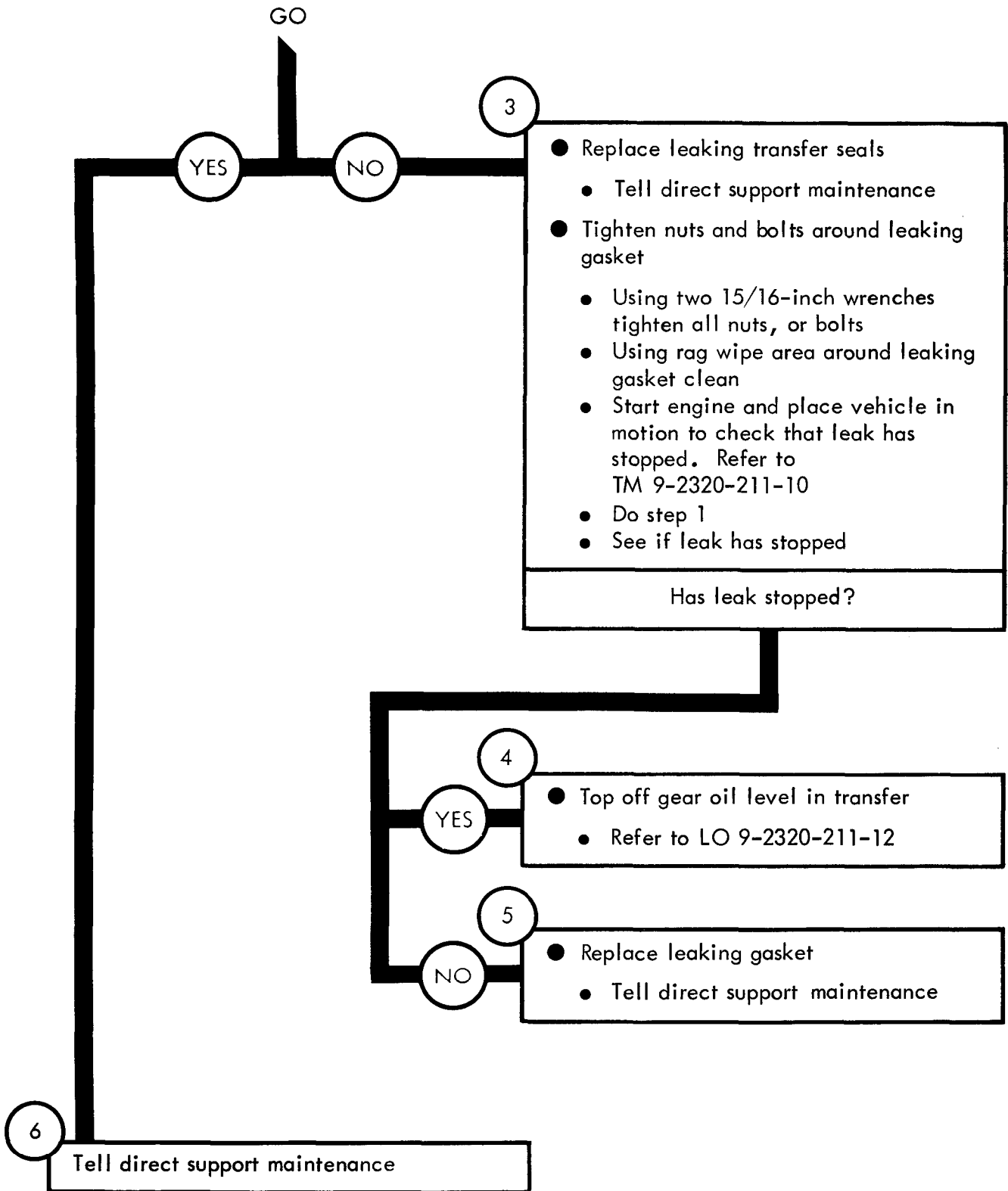

Figure 33-1 (Sheet 1 of 2)



TA 116109

Figure 33-1 (Sheet 2 of 2)

Symptom

2 TRANSFER IS HARD TO SHIFT, OR POPS OUT OF GEAR

- 1
- Make truck ready for work on transfer
 - Park truck. Refer to TM 9-2320-211-10

- 2
- Check for bent transfer linkage
 - Crawl under truck
 - Look closely for signs of bent linkage
- Is linkage OK?

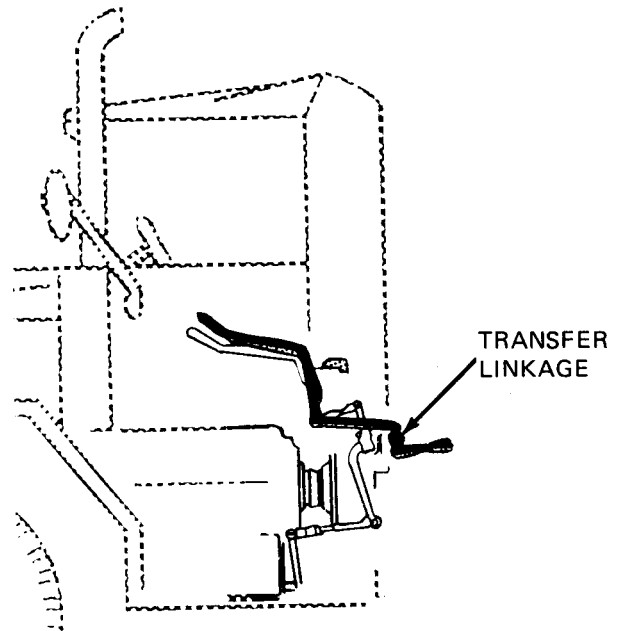

- YES
- NO
- 3
- Replace bent transfer linkage
 - Tell direct support maintenance
- GO

Figure 33-2 (Sheet 1 of 2)

GO

NOTE

This procedure will need the use of two soldiers. The lead soldier will be called SOLDIER A, and the helper will be called SOLDIER B

4

- Check transfer shift linkage
- SOLDIER B ● Go to driver's seat and wait for instructions from SOLDIER A
- SOLDIER A ● Crawl under truck
- Tell SOLDIER B to shift transfer lever
 - Look for signs of the linkage binding at linkage ends
 - See if shifting fork lever moves all the way in and out

Is linkage OK?

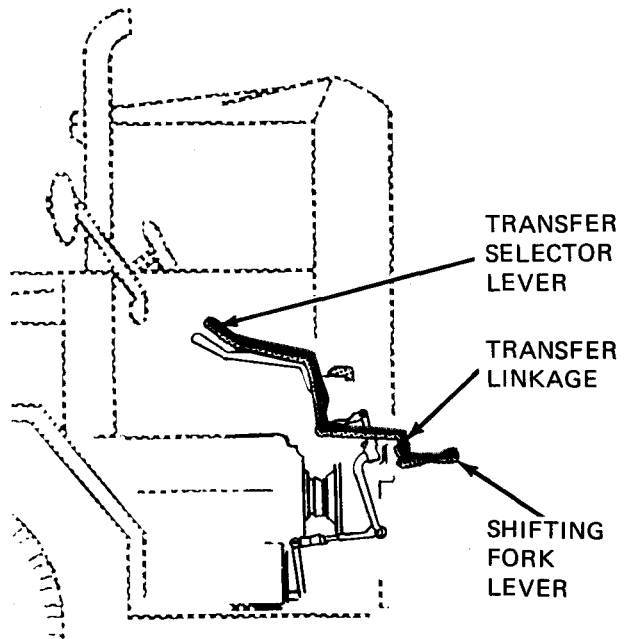

5

- Lubricate binding linkages
 - Refer to LO 9-2320-211-12
- Adjust transfer linkage
- Tell direct support maintenance

YES

NO

6

Tell direct support maintenance

TA 116111

Figure 33-2 (Sheet 2 of 2)

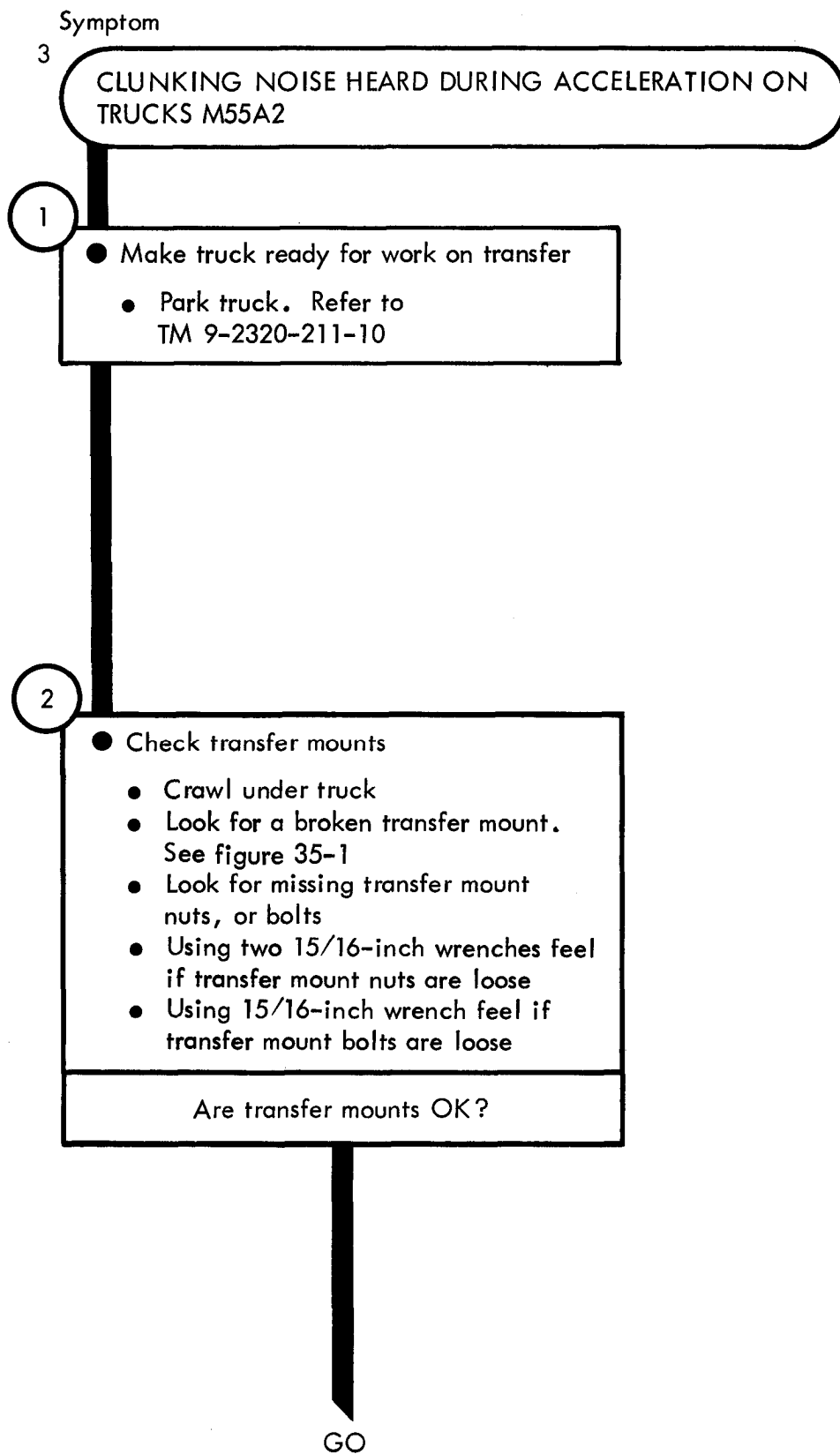

TA 116112

Figure 33-3 (Sheet 1 of 4)

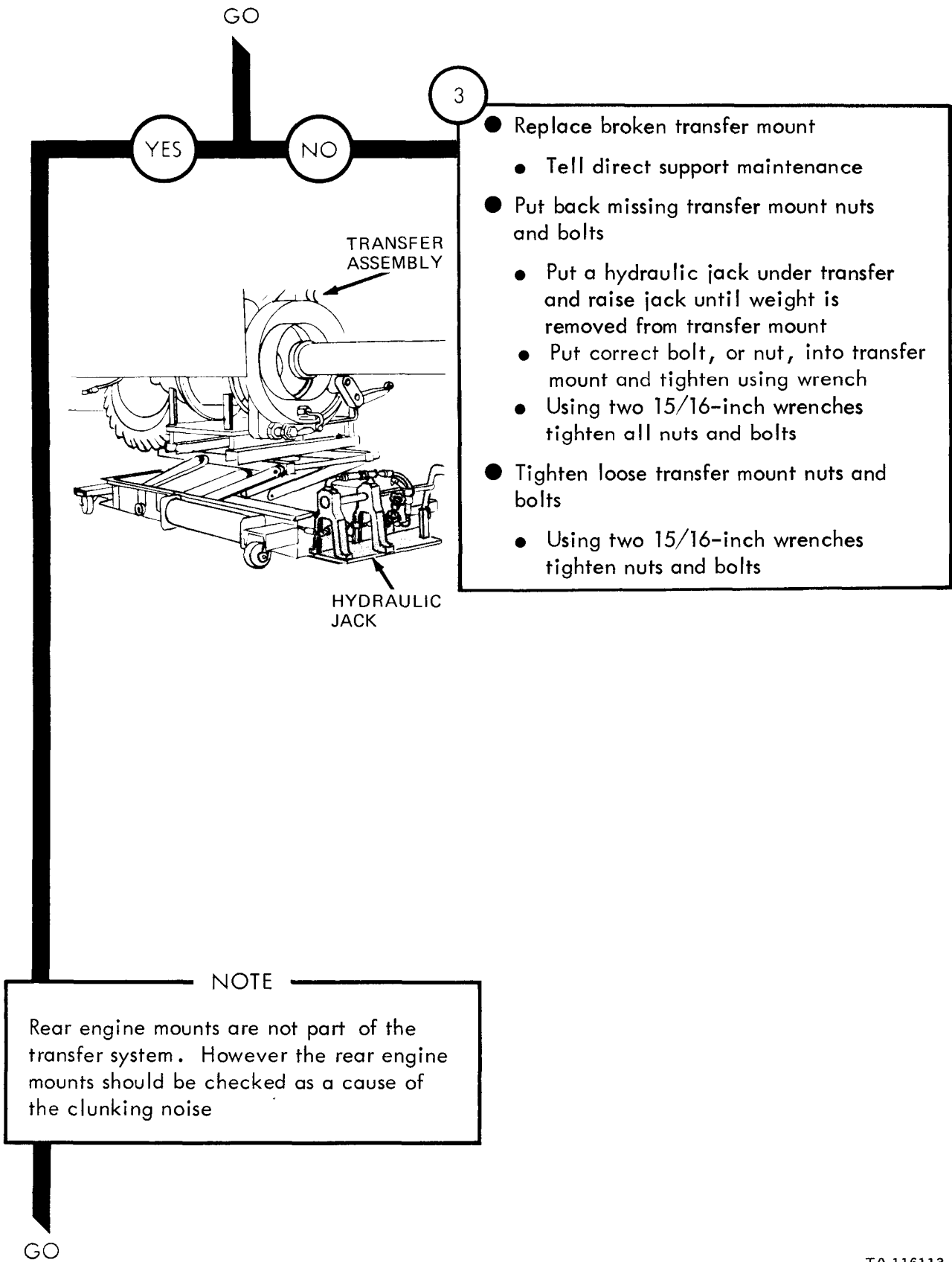

- 3
- Replace broken transfer mount
 - Tell direct support maintenance
 - Put back missing transfer mount nuts and bolts
 - Put a hydraulic jack under transfer and raise jack until weight is removed from transfer mount
 - Put correct bolt, or nut, into transfer mount and tighten using wrench
 - Using two 15/16-inch wrenches tighten all nuts and bolts
 - Tighten loose transfer mount nuts and bolts
 - Using two 15/16-inch wrenches tighten nuts and bolts

NOTE

Rear engine mounts are not part of the transfer system. However the rear engine mounts should be checked as a cause of the clunking noise

Figure 33-3 (Sheet 2 of 4)

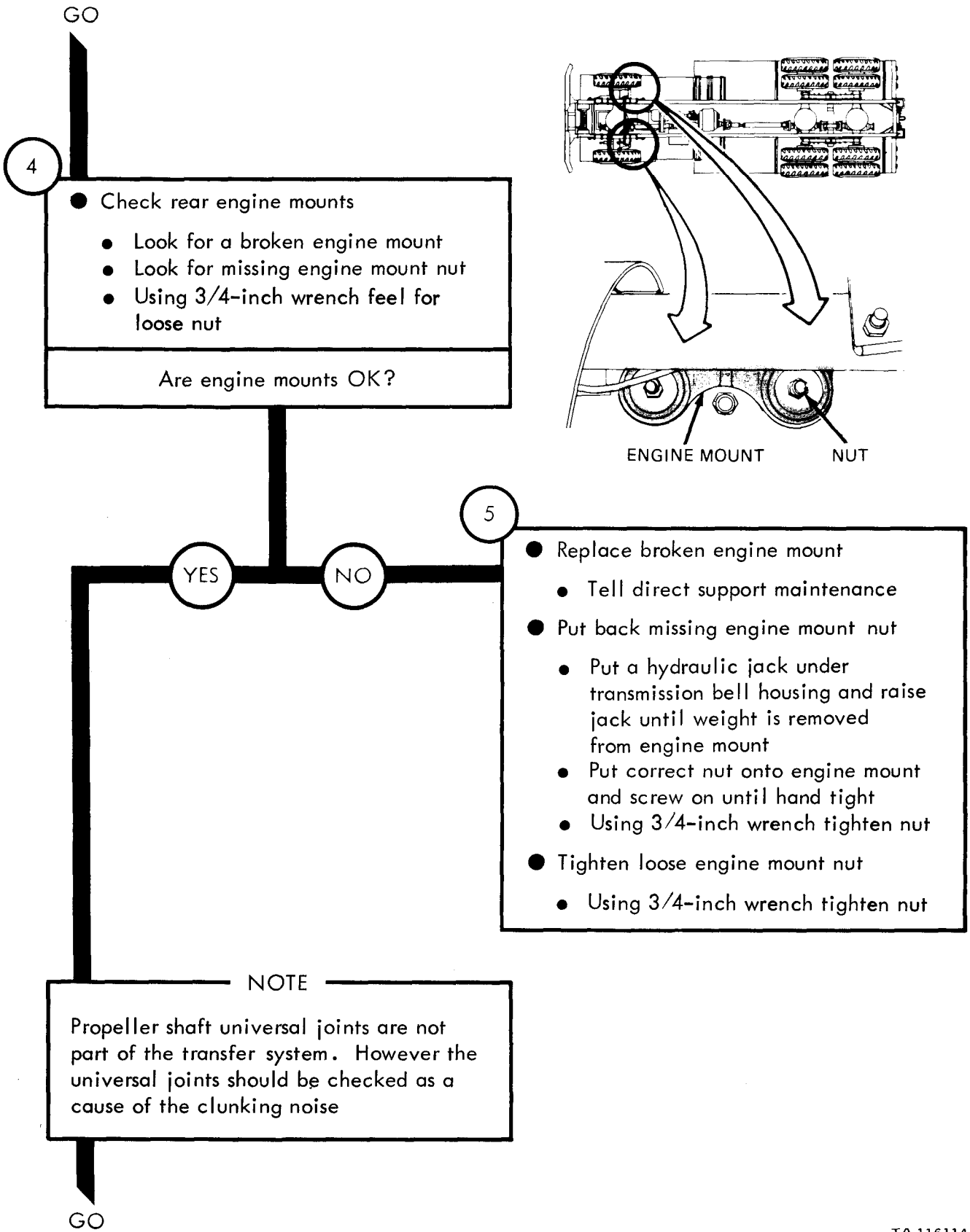

Figure 33-3 (Sheet 3 of 4)

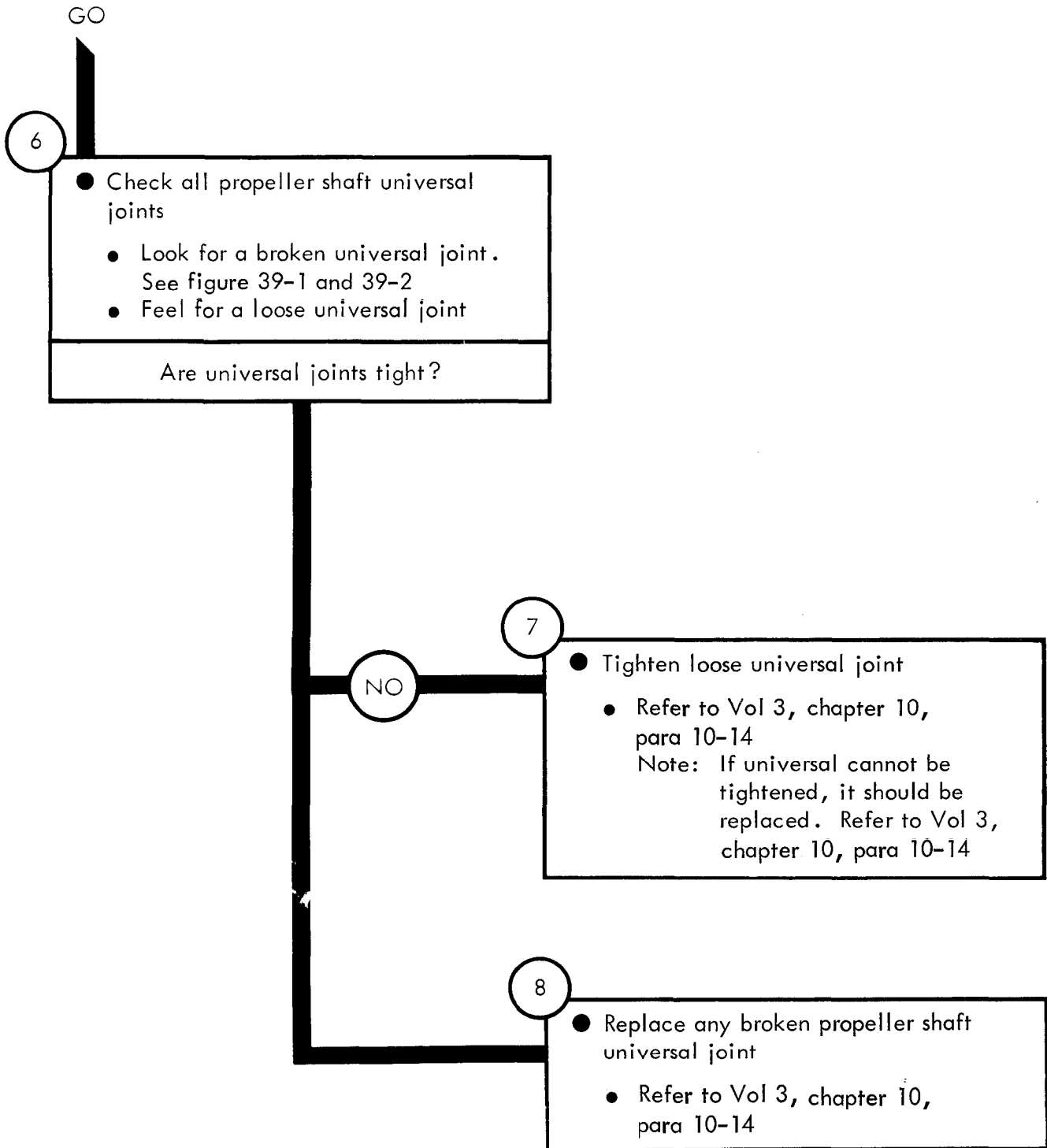

Figure 33-3 (Sheet 4 of 4)

TA 116115

Symptom

4

CLUNKING NOISE HEARD DURING ACCELERATION ON ALL TRUCKS BUT M55A2

1

- Make truck ready for work on transfer
 - Park truck. Refer to TM 9-2320-211-10

2

- Check transfer mounts
 - Crawl under truck
 - Look for a broken transfer mount. See figure 39-1 and 39-2
 - Look for missing transfer mount bolts
 - Using two 15/16-inch wrenches feel if transfer mount nuts are loose
- Are transfer mounts OK?

GO

Figure 33-4 (Sheet 1 of 5)

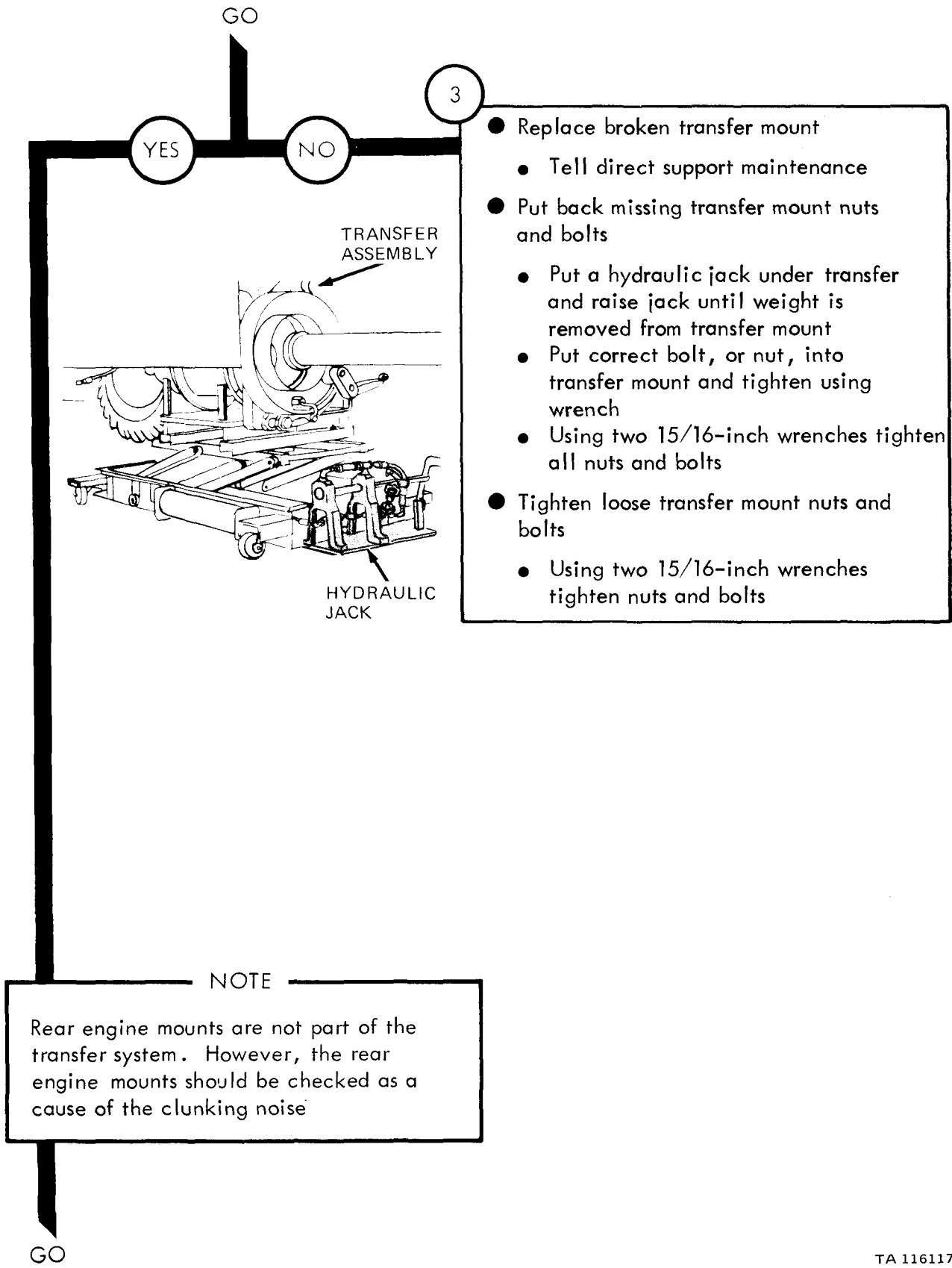

Figure 33-4 (Sheet 2 of 5)

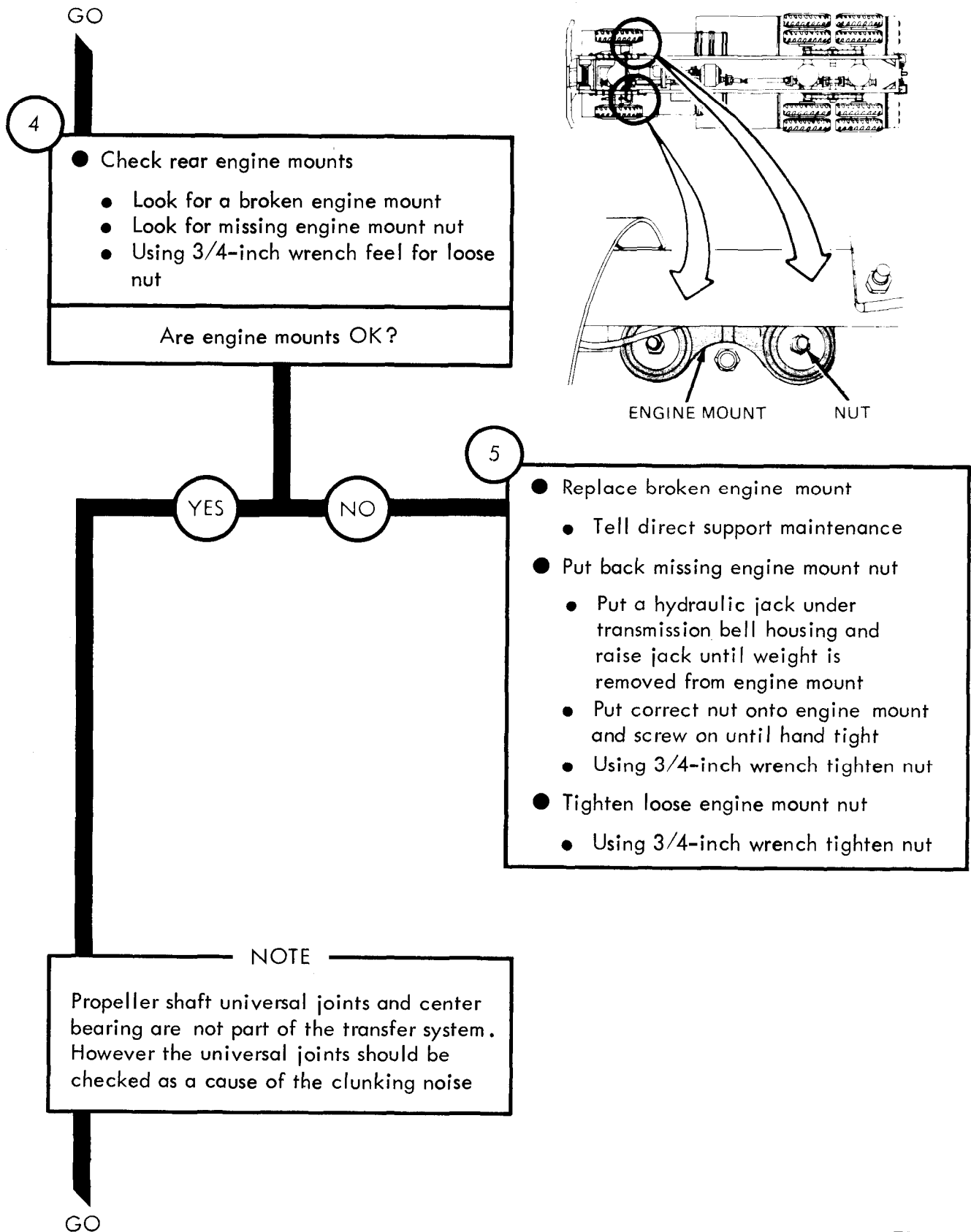
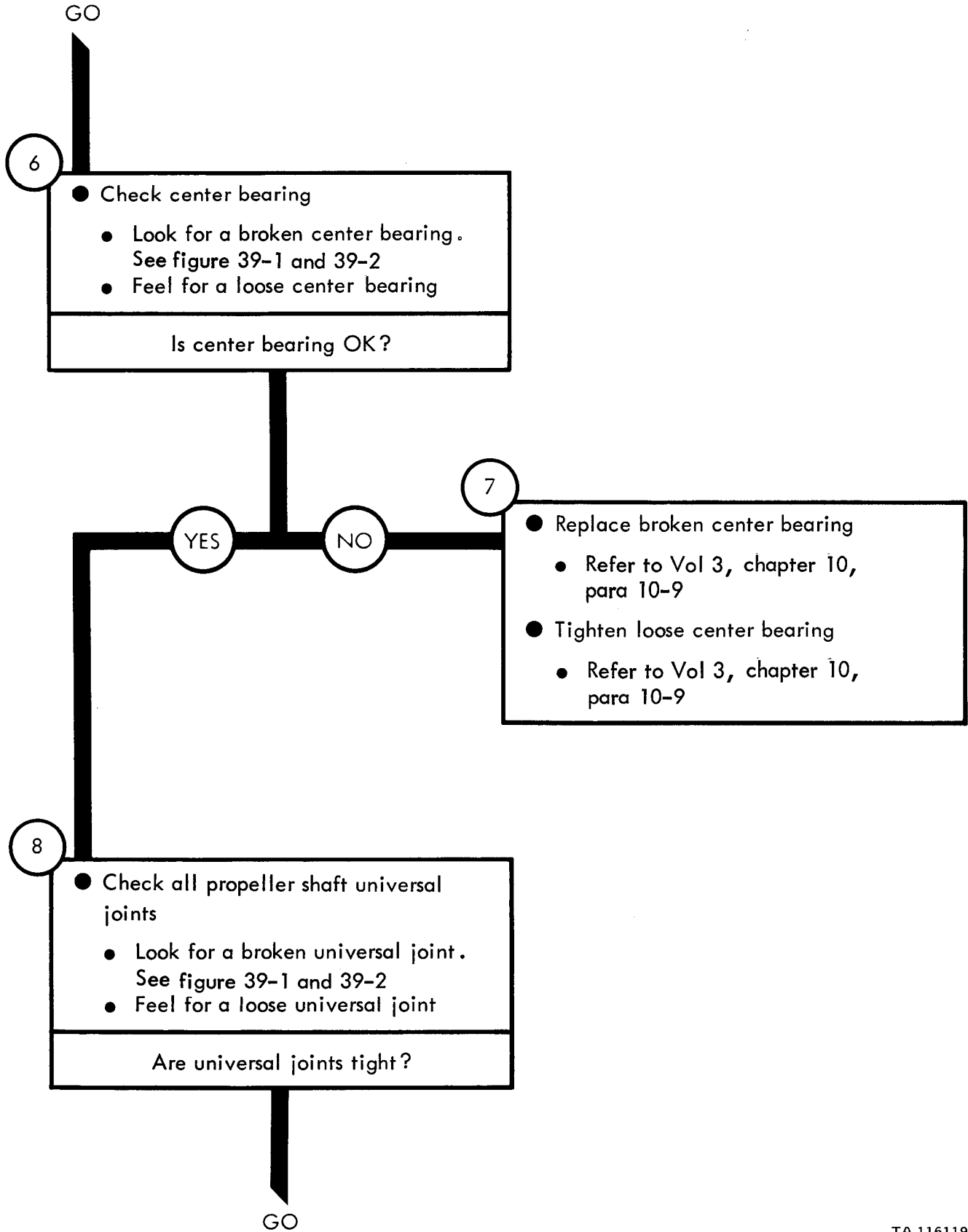

Figure 33-4 (Sheet 3 of 5)



TA 116119

Figure 33-4 (Sheet 4 of 5)

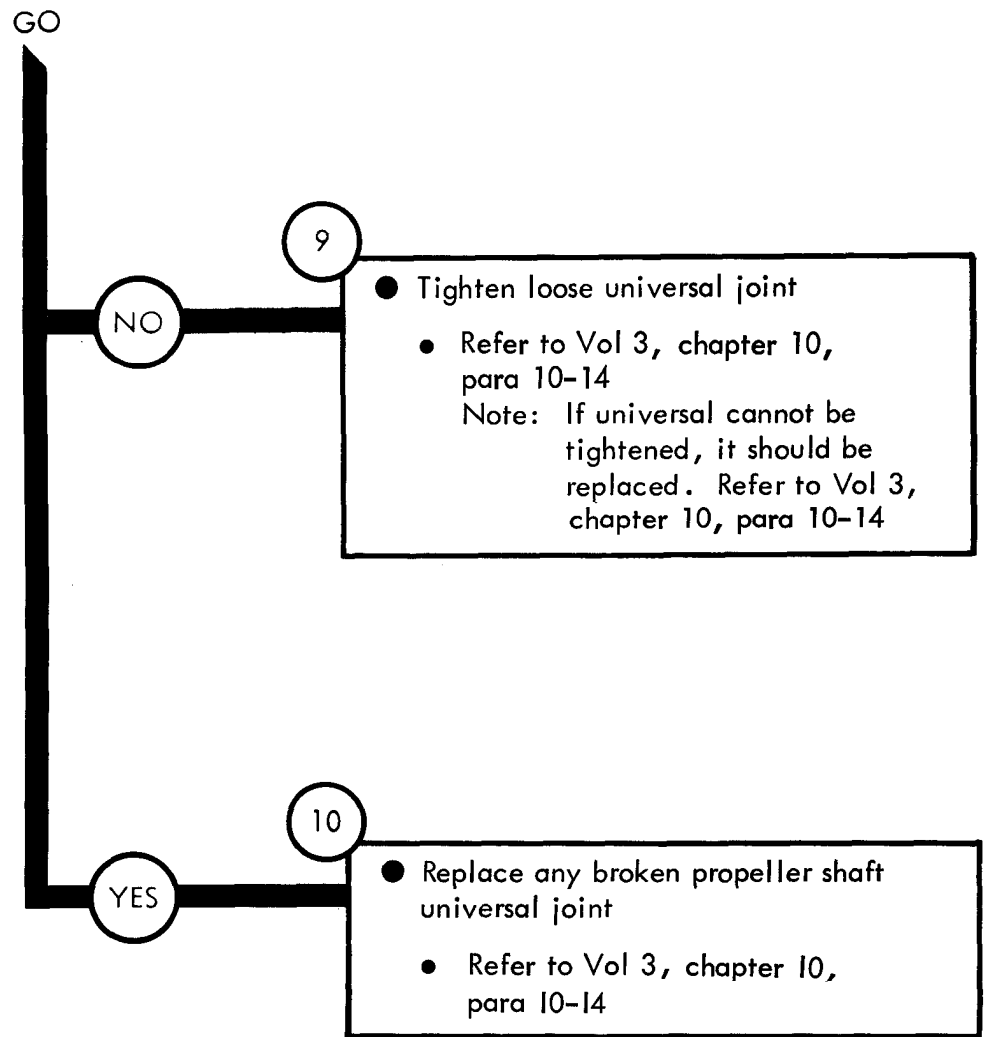

Figure 33-4 (Sheet 5 of 5)

CHAPTER 34

TRANSFER SYSTEM TROUBLESHOOTING SUMMARY

34-1. GENERAL. This chapter gives a summary of troubleshooting procedures given in chapter 33, for the Transfer System.

34-2. PROCEDURES . The summary in this chapter covers all fault symptoms found in the detailed troubleshooting procedures in Part 1. Chapter 7 outlines a sample troubleshooting procedure. The summary procedures are based on the "what-to-do" portions of the detailed procedures and do not include the "How-to-do-it" instructions. Warnings, cautions, and notes are given where needed.

TRANSFER SYSTEM TROUBLESHOOTING SUMMARY

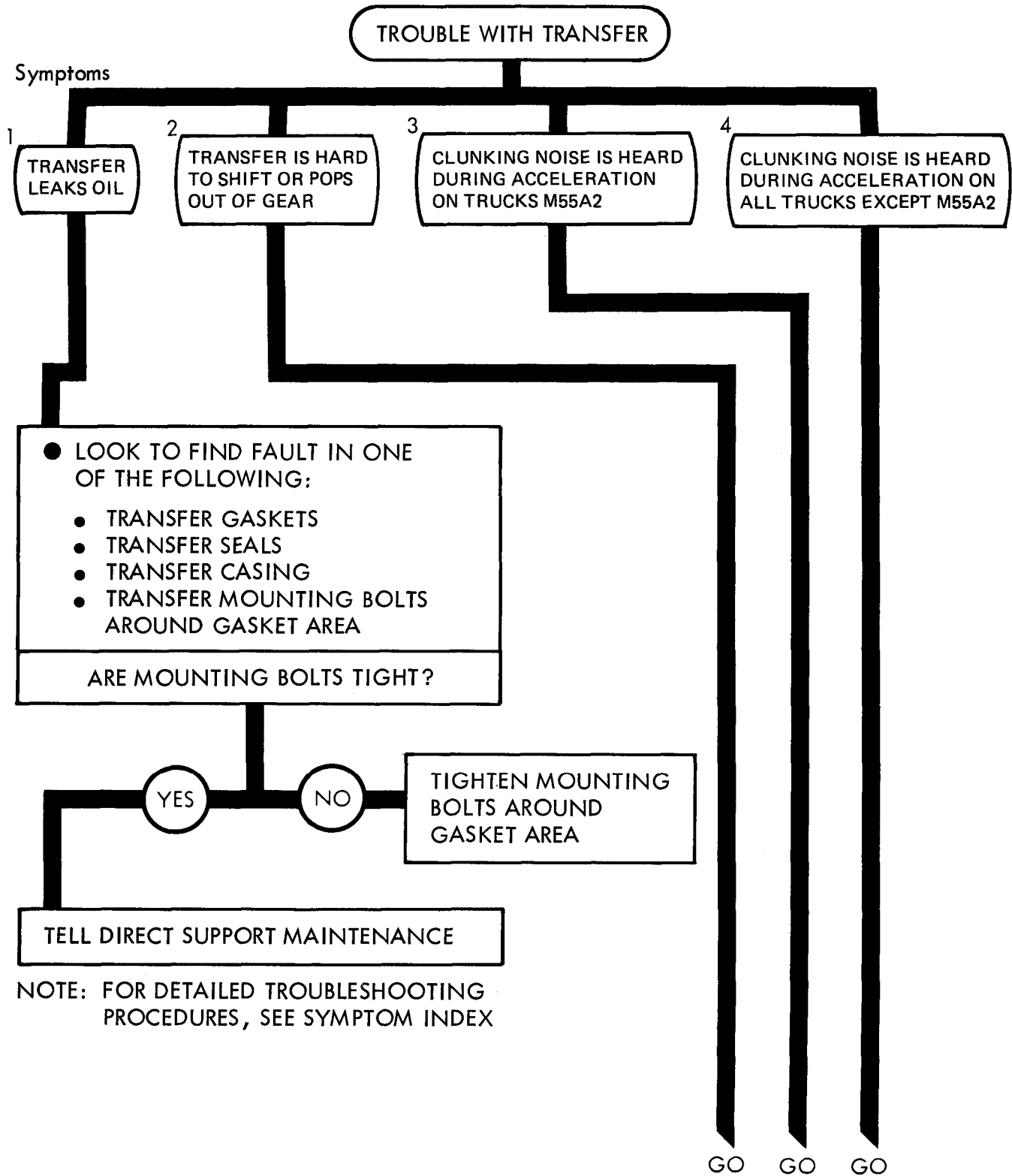

NOTE: FOR DETAILED TROUBLESHOOTING PROCEDURES, SEE SYMPTOM INDEX

Figure 34-1 (Sheet 1 of 3)

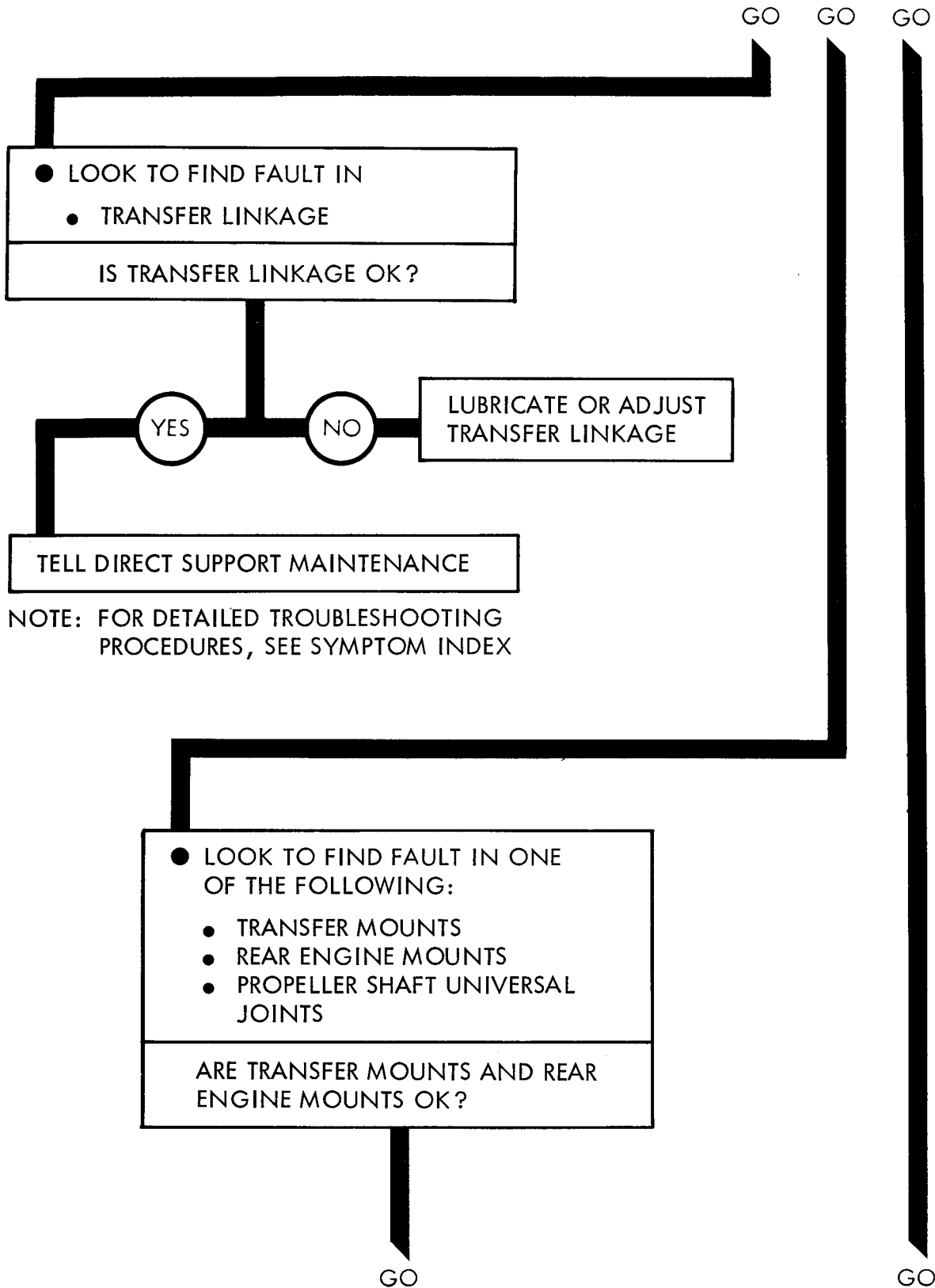

Figure 34-1 (Sheet 2 of 3)

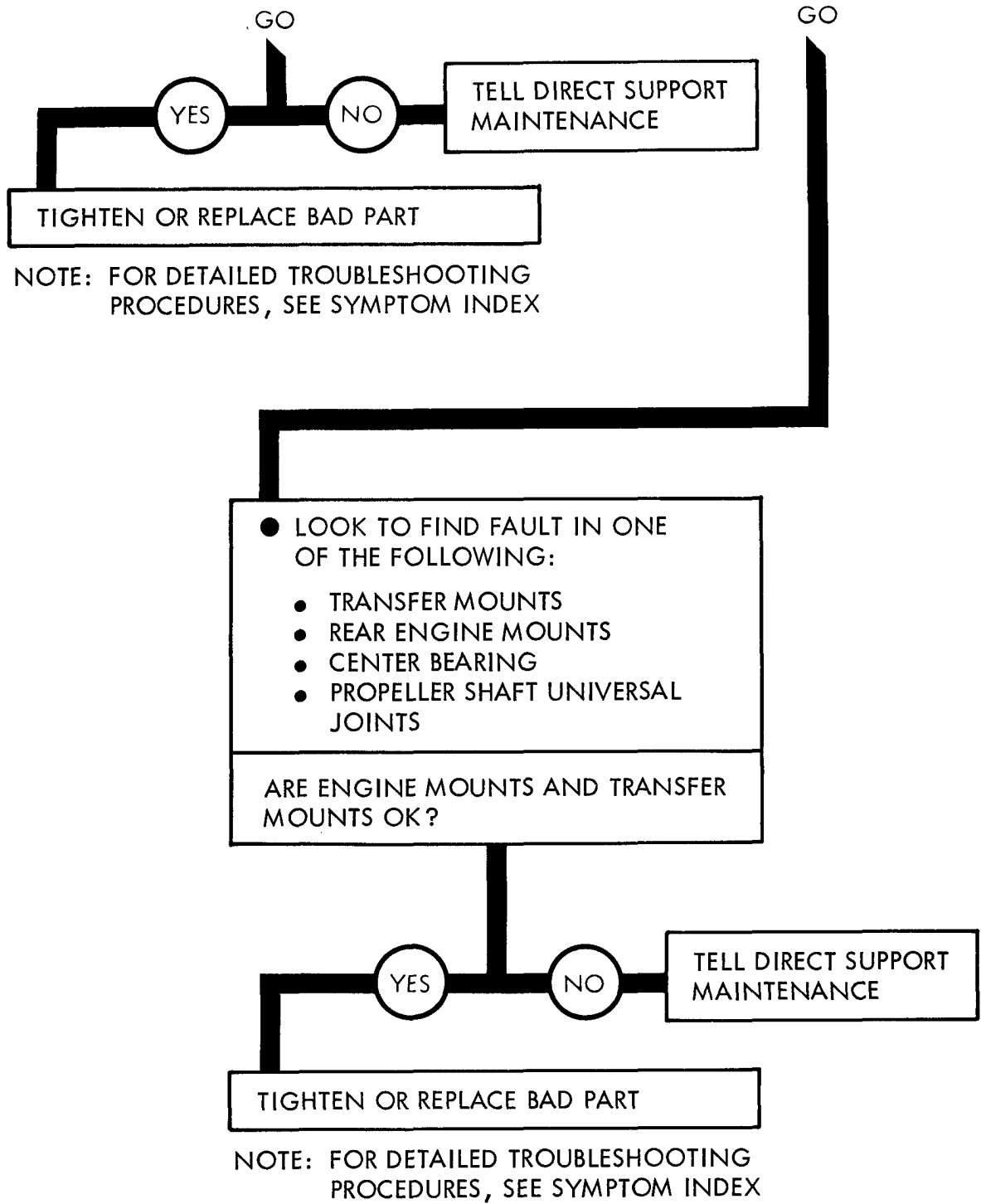
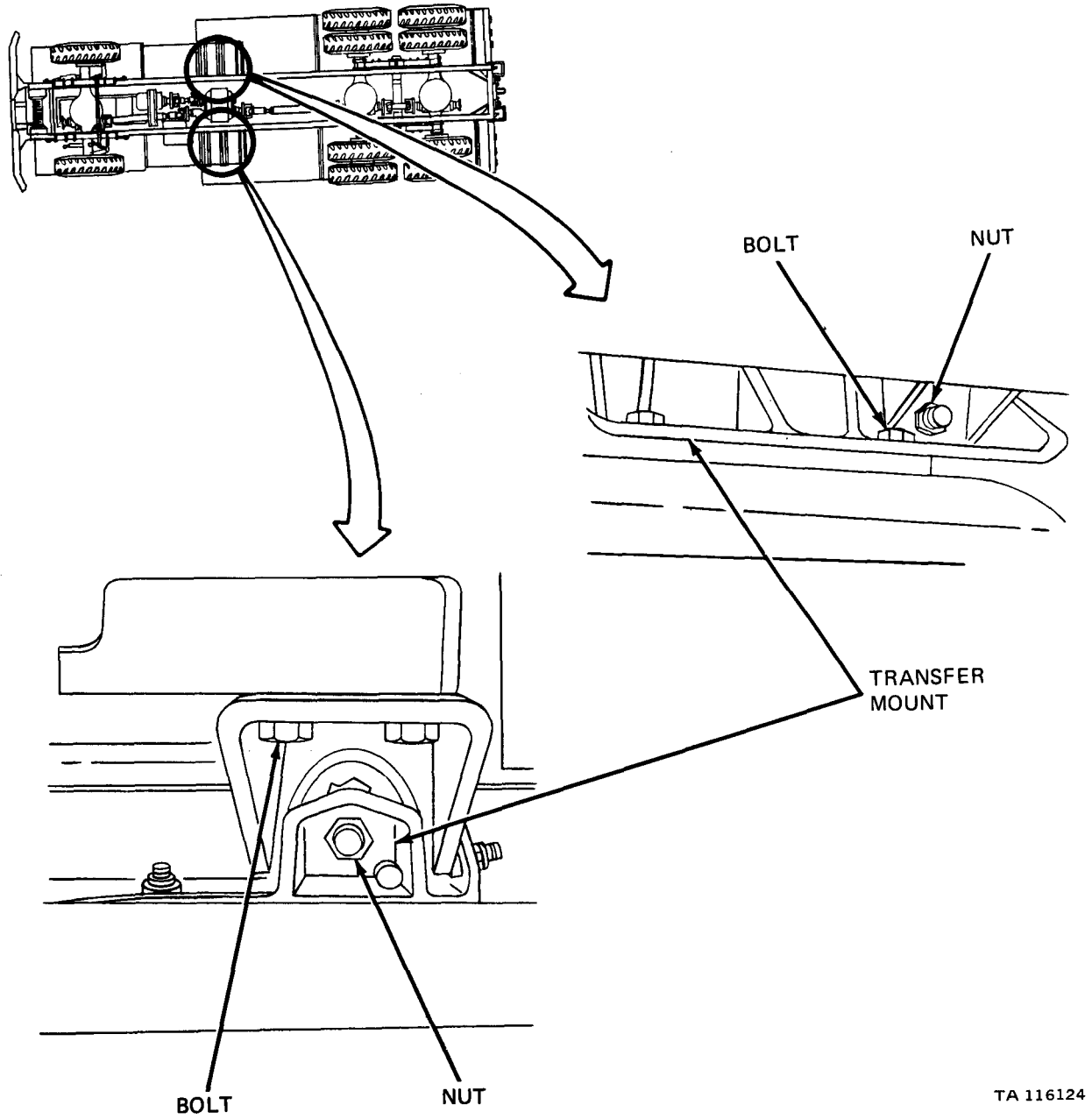

Figure 34-1 (Sheet 3 of 3)

CHAPTER 35

TRANSFER SYSTEM SUPPORT DIAGRAMS

35-1. GENERAL. This chapter gives the diagrams you need when doing troubleshooting procedures in chapter 33. Table 3-1 is a complete listing of all support diagrams used in this manual.



TA 116124

Figure 35-1

CHAPTER 36

TRANSFER SYSTEM CHECKOUT PROCEDURES

36-1. GENERAL. This chapter gives procedures for checking out the system after troubleshooting and repair have been done. Procedures are set up in flow chart form showing the checkout steps in order and referring to the fault symptom index when the system does not check out.

TRANSFER SYSTEM CHECKOUT

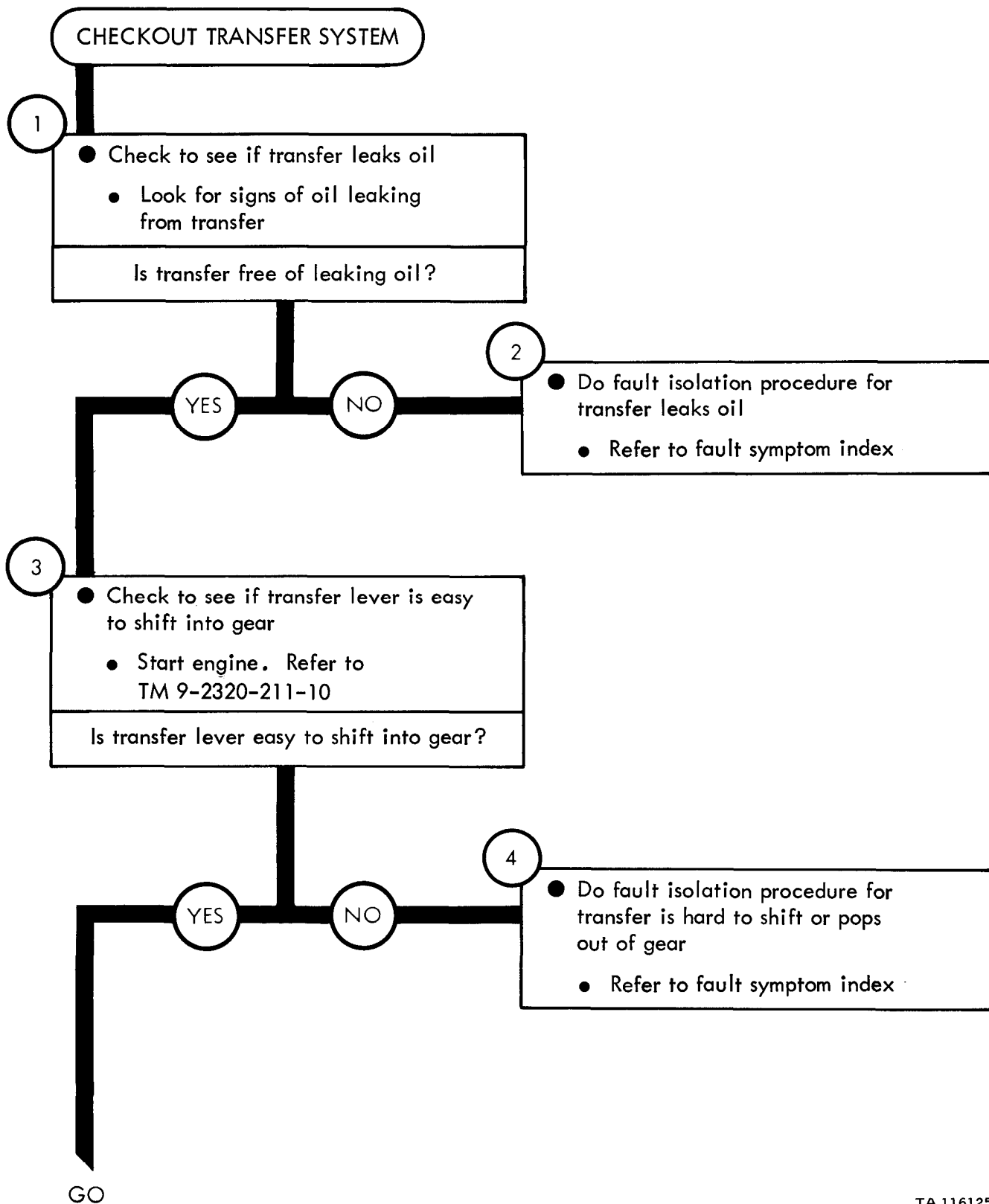

Figure 36-1 (Sheet 1 of 2)

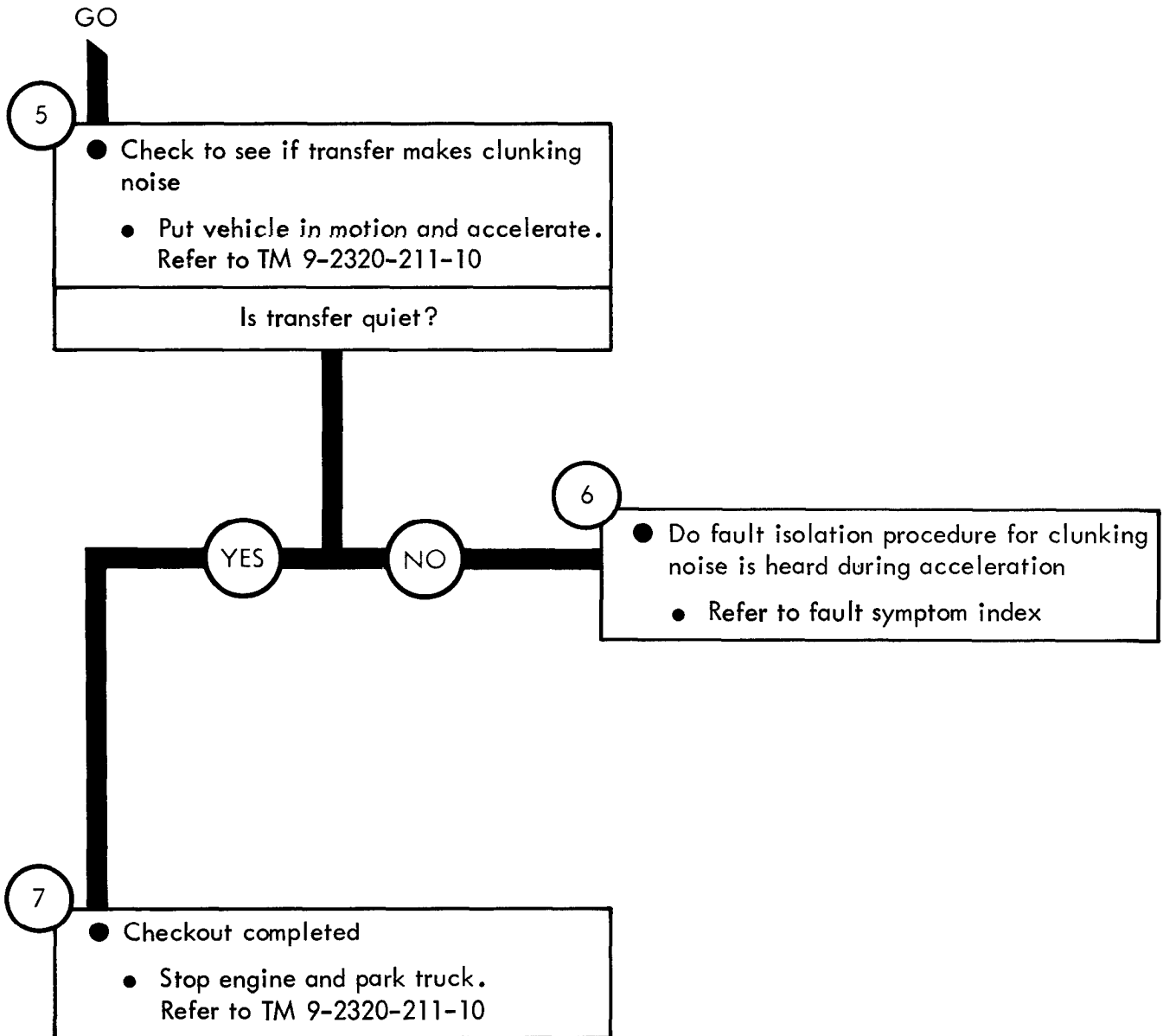

Figure 36-1 (Sheet 2 of 2)

CHAPTER 37

PROPELLER SHAFT SYSTEM TROUBLESHOOTING

37-1. EQUIPMENT ITEMS COVERED. This chapter gives equipment troubleshooting procedures for the propeller shaft system, for which there are authorized corrective maintenance tasks at the organizational maintenance level.

37-2. EQUIPMENT ITEMS NOT COVERED. All equipment items for which corrective maintenance is authorized at the organizational maintenance level are covered in this chapter.

PROPELLER SHAFT SYSTEM TROUBLESHOOTING

Symptom

1

CLUNKING NOISE HEARD DURING ACCELERATION ON TRUCK M55A2

1

- Make truck ready for work on propeller shafts
 - Park truck. Refer to TM 9-2320-211-10

NOTE

Transfer mounts are not part of the propeller shaft system. However the transfer mounts should be checked as a cause of the clunking noise

2

- Check transfer mounts
 - Crawl under truck
 - Look for a broken transfer mount. See figure 35-1
 - Look for missing transfer mount nuts, or bolts
 - Using two 15/16-inch wrenches feel if transfer mount nuts are loose
 - Using 15/16-inch wrench feel if transfer mount bolts are loose

Are transfer mounts OK?

GO

Figure 37-1 (Sheet 1 of 5)

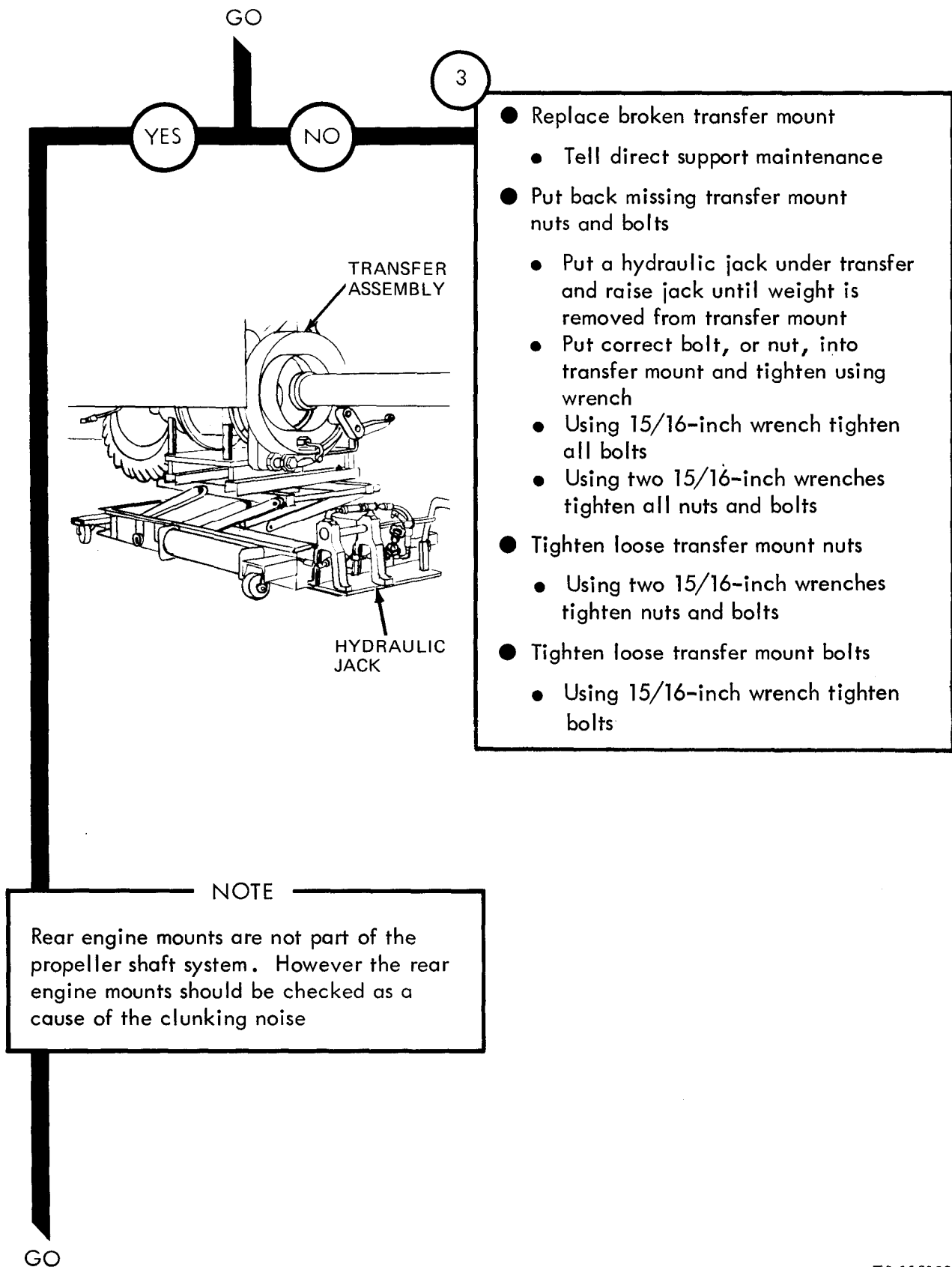

Figure 37-1 (Sheet 2 of 5)

TA 116128

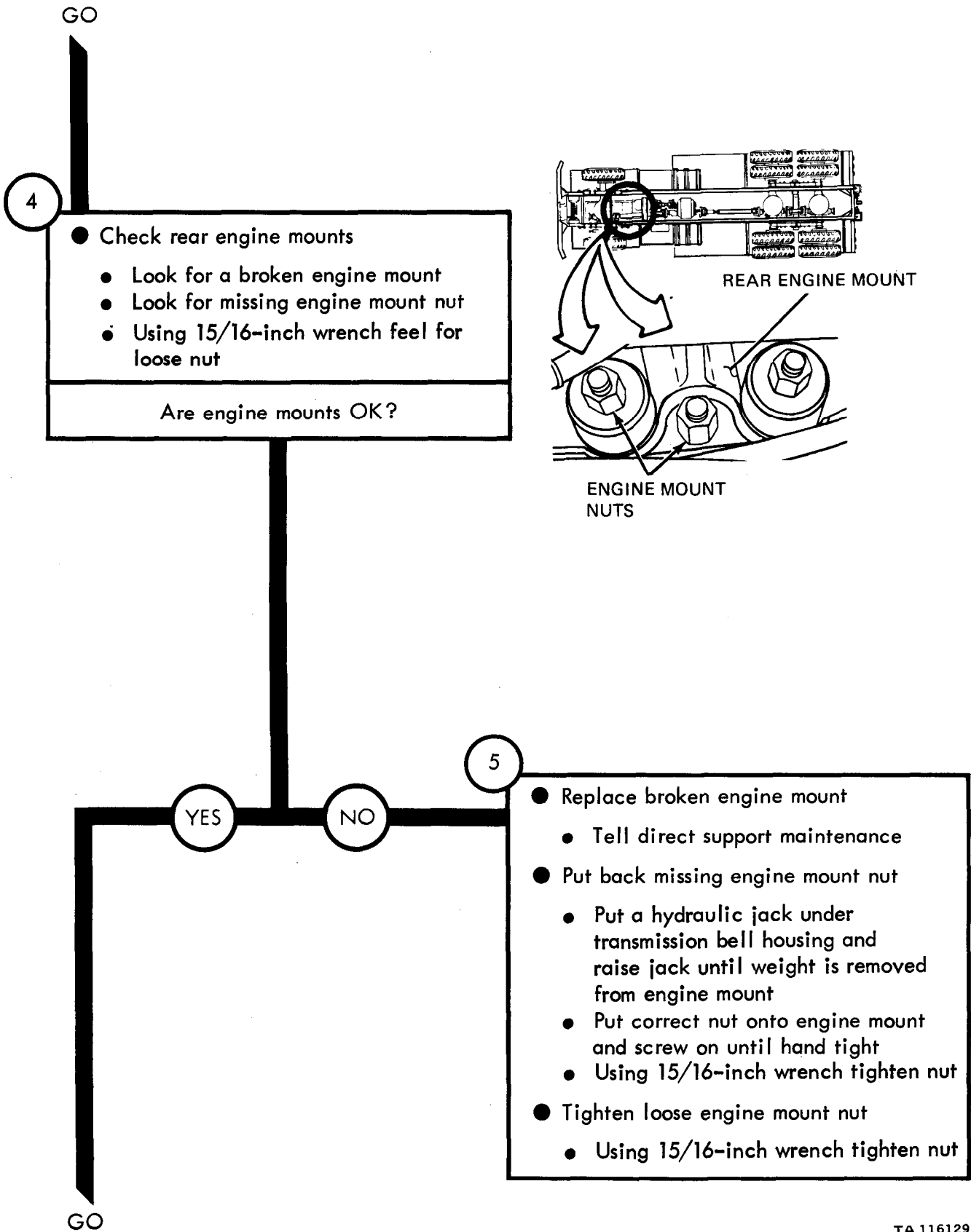

Figure 37-1 (Sheet 3 of 5)

TA 116129

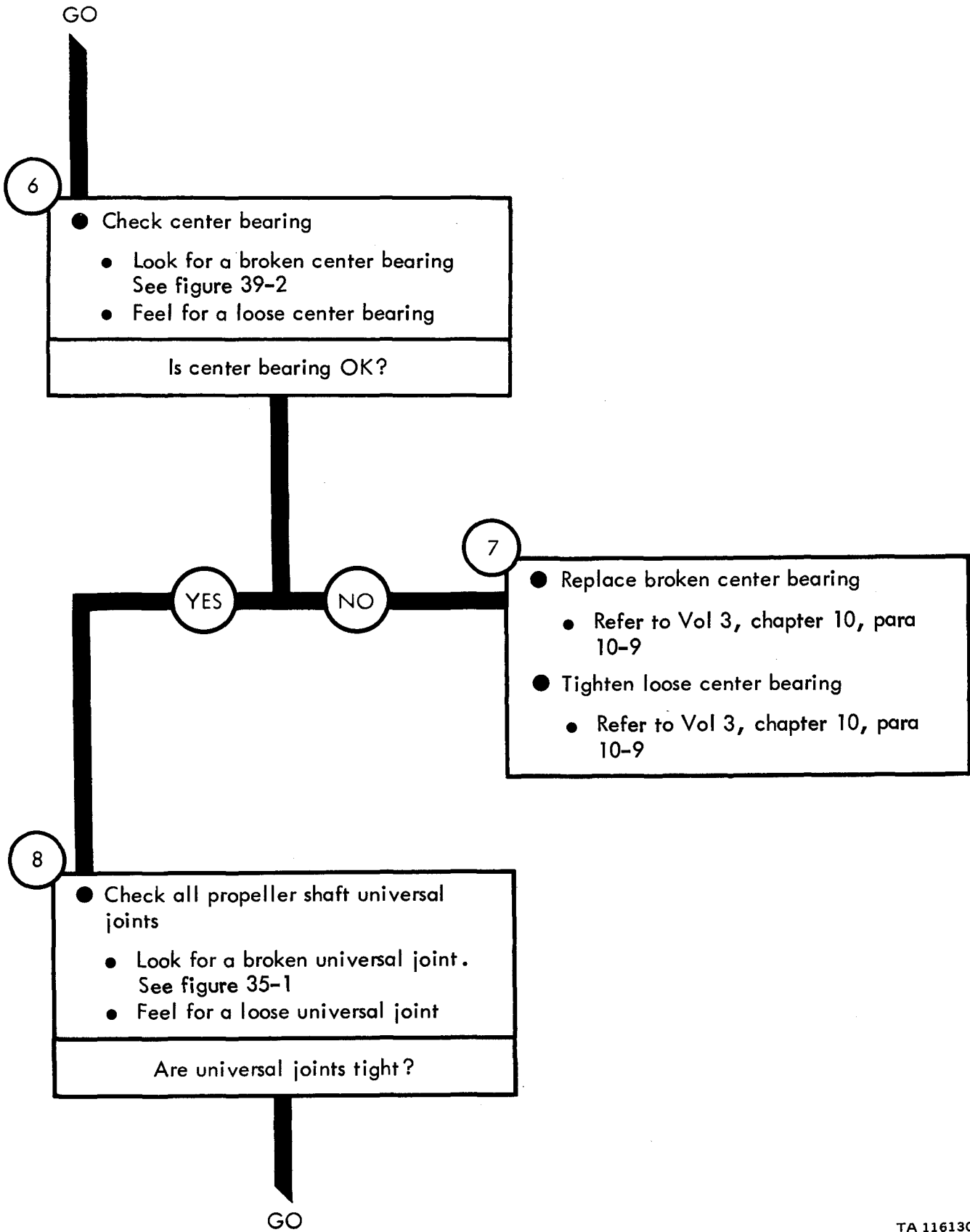

Figure 37-1 (Sheet 4 of 5)

TA 116130

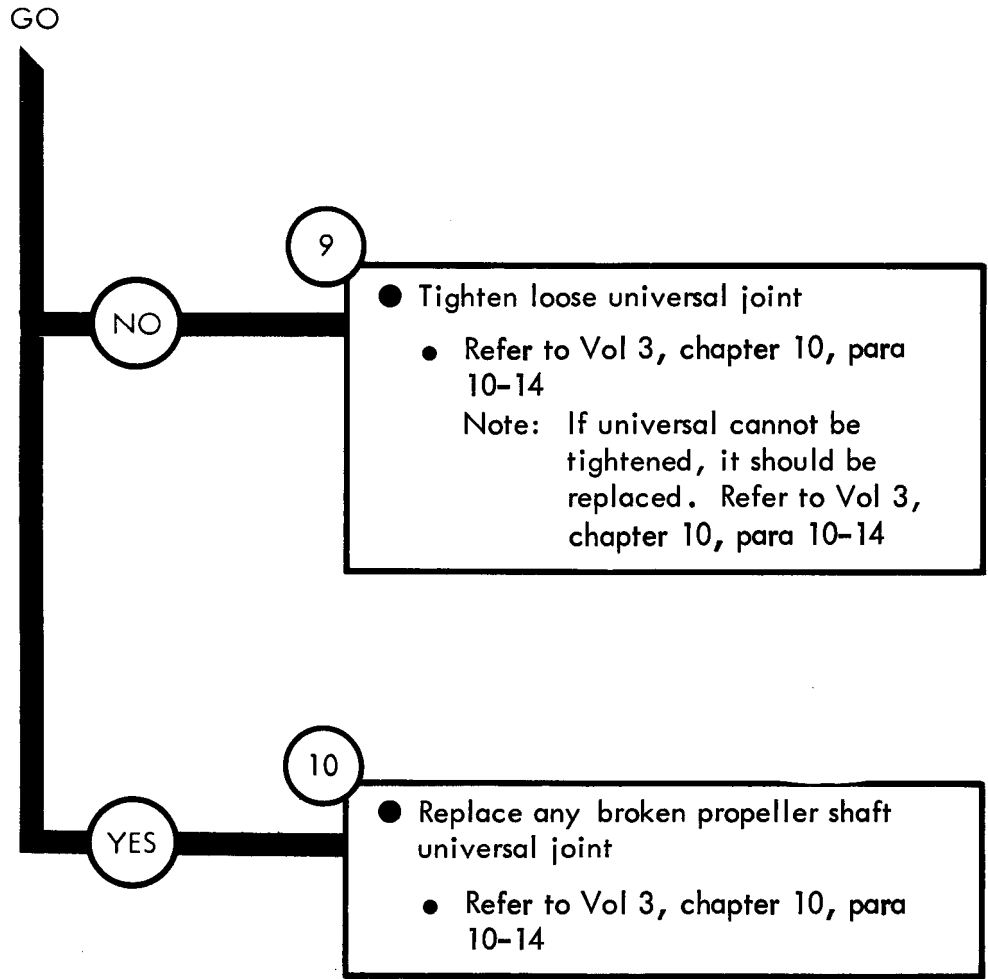

Figure 37-1 (Sheet 5 of 5)

PROPELLER SHAFT SYSTEM TROUBLESHOOTING

Symptom

2

CLUNKING NOISE HEARD DURING ACCELERATION ON ALL TRUCKS EXCEPT M55A2

1

- Make truck ready for work on propeller shafts
 - Park truck. Refer to TM 9-2320-211-10

NOTE

Transfer mounts are not part of the propeller shaft system. However, the transfer mounts should be checked as a cause of the clunking noise

2

- Check transfer mounts
 - Crawl under truck
 - Look for a broken transfer mount. See figure 35-1
 - Look for missing transfer mount bolts
 - Using two 15/16-inch wrenches feel if transfer mount nuts are loose
 - Using 15/16-inch wrench feel if transfer mount bolts are loose

Are transfer mounts OK?



GO

Figure 37-2 (Sheet 1 of 4)

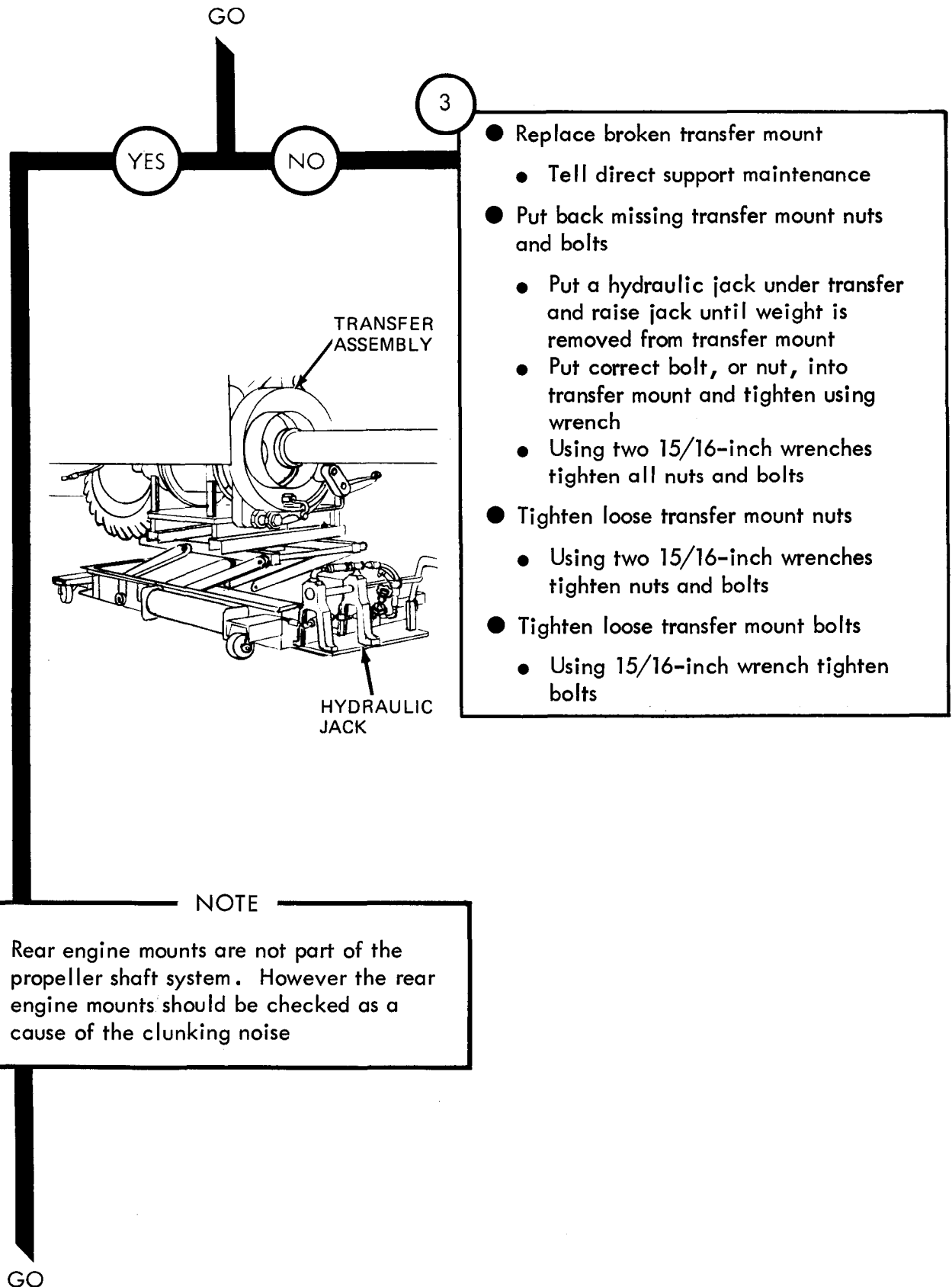

- Replace broken transfer mount
 - Tell direct support maintenance
- Put back missing transfer mount nuts and bolts
 - Put a hydraulic jack under transfer and raise jack until weight is removed from transfer mount
 - Put correct bolt, or nut, into transfer mount and tighten using wrench
 - Using two 15/16-inch wrenches tighten all nuts and bolts
- Tighten loose transfer mount nuts
 - Using two 15/16-inch wrenches tighten nuts and bolts
- Tighten loose transfer mount bolts
 - Using 15/16-inch wrench tighten bolts

Figure 37-2 (Sheet 2 of 4)

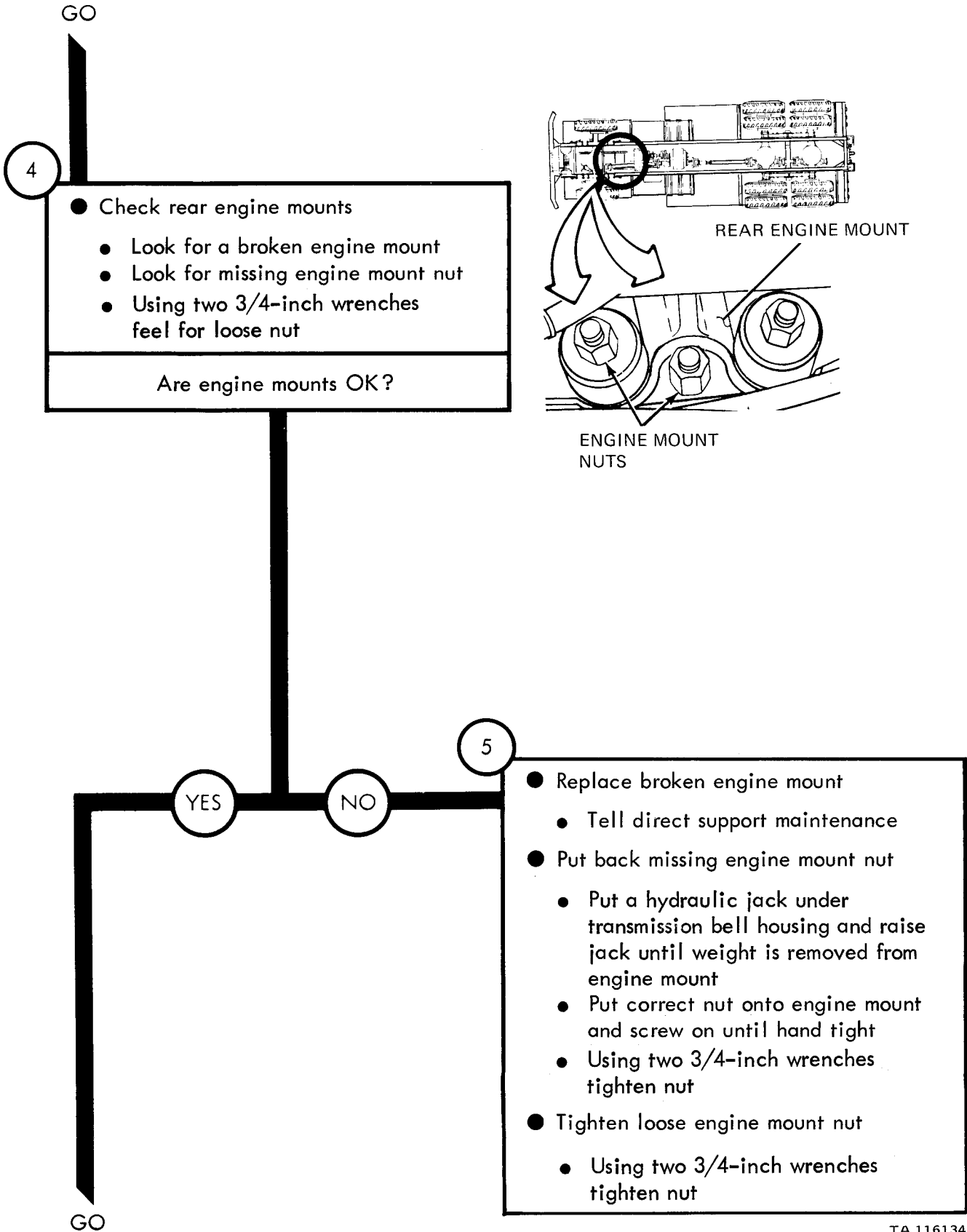

Figure 37-2 (Sheet 3 of 4)

TA 116134

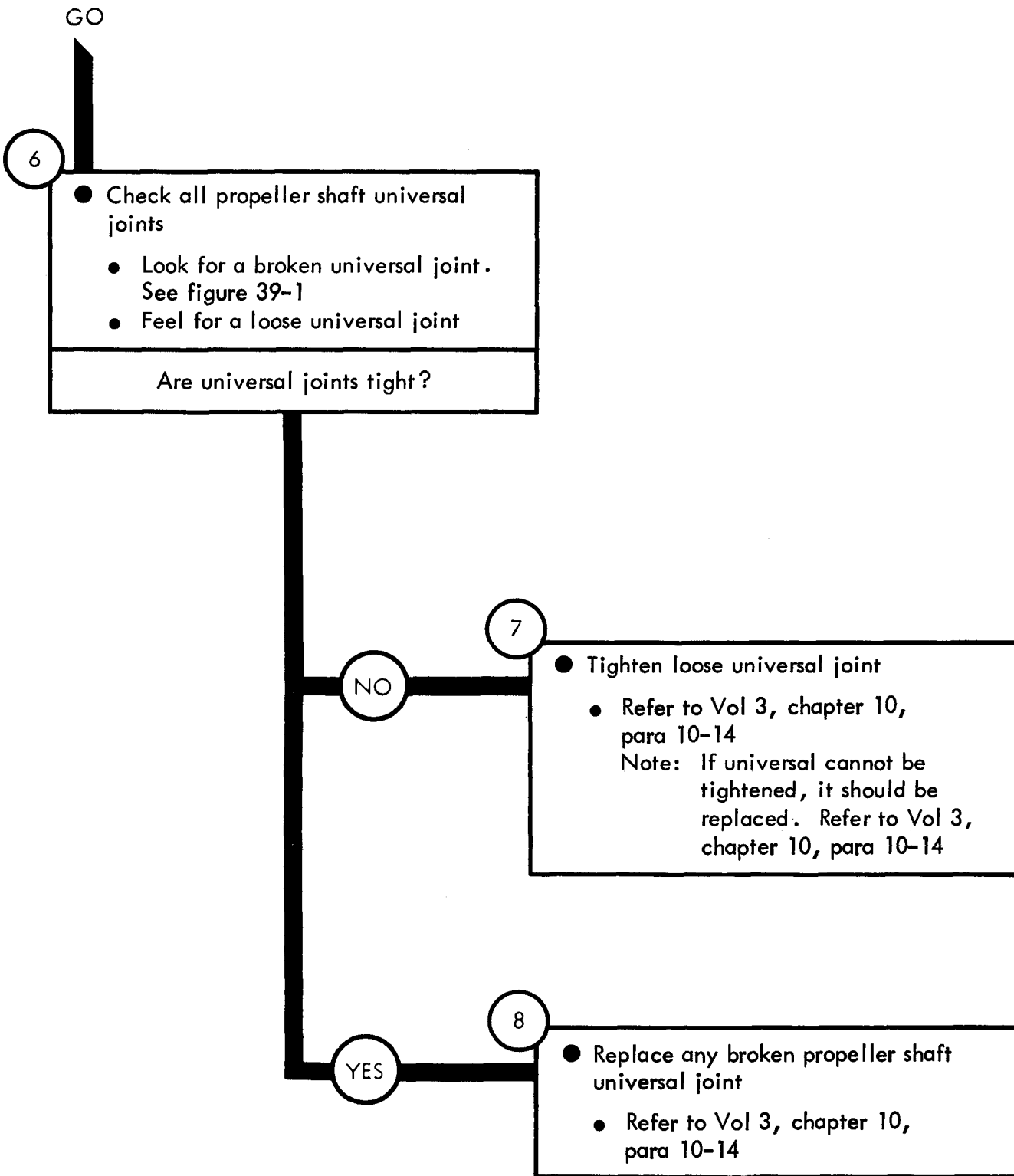

Figure 37-2 (Sheet 4 of 4)

CHAPTER 38

PROPELLER SHAFT SYSTEM TROUBLESHOOTING SUMMARY

38-1. GENERAL. This chapter gives a summary of troubleshooting procedures given in chapter 37, for the Propeller Shaft System.

38-2. PROCEDURES. The summary in this chapter covers all fault symptoms found in the detailed troubleshooting procedures in Part 1. Chapter 7 outlines a sample troubleshooting procedure. The summary procedures are based on the "what-to-do" portions of the detailed procedures and do not include the "How-to-do-it" instructions. Warnings, cautions, and notes are given where needed.

PROPELLER SHAFT SYSTEM TROUBLESHOOTING SUMMARY

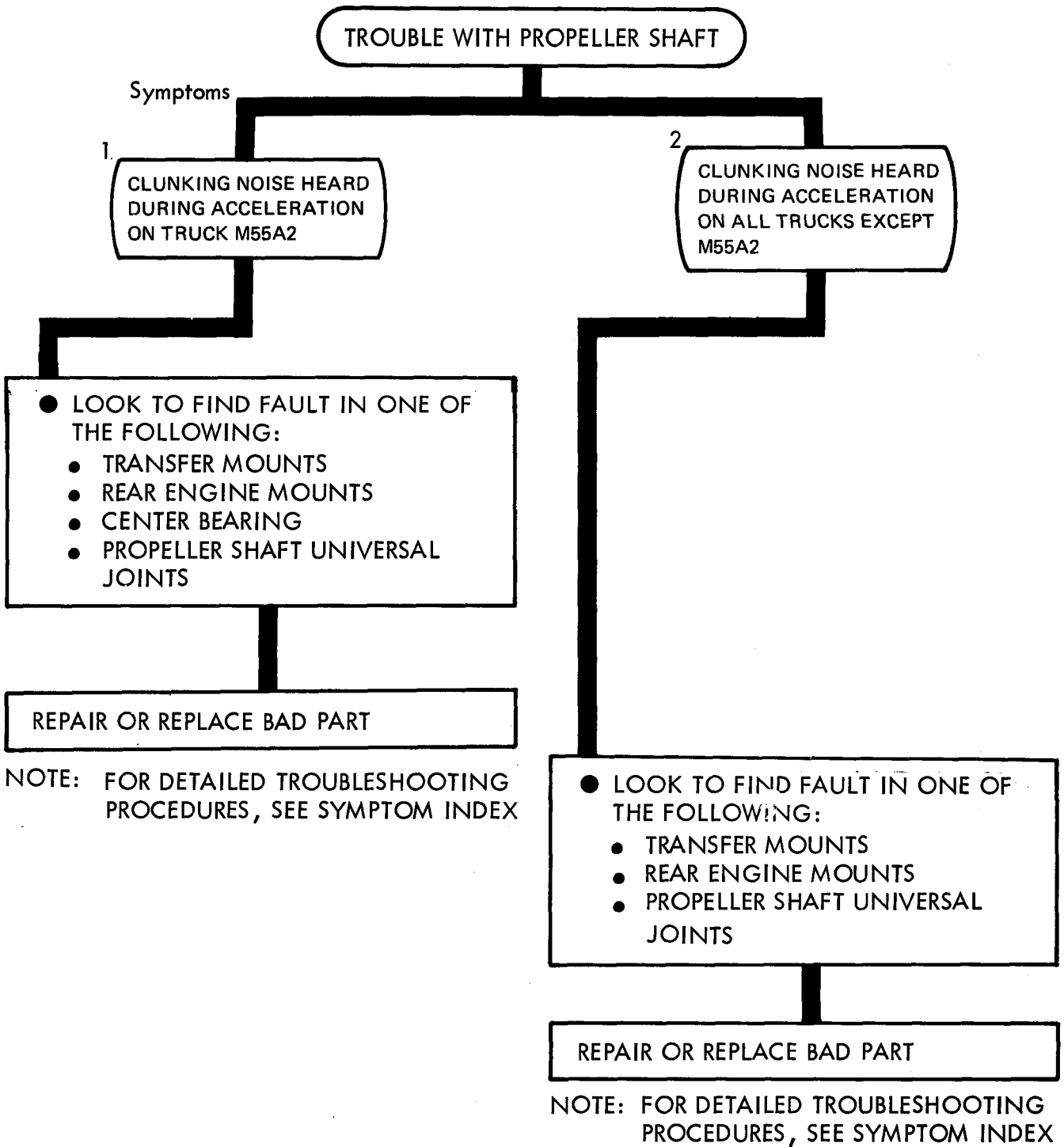

Figure 38-1

TA 116136

CHAPTER 39

PROPELLER SHAFT SYSTEM SUPPORT DIAGRAMS

39-1. GENERAL. This chapter gives the diagrams you need when doing troubleshooting procedures in chapter 37. Table 3-1 is a complete listing of all support diagrams used in this manual.

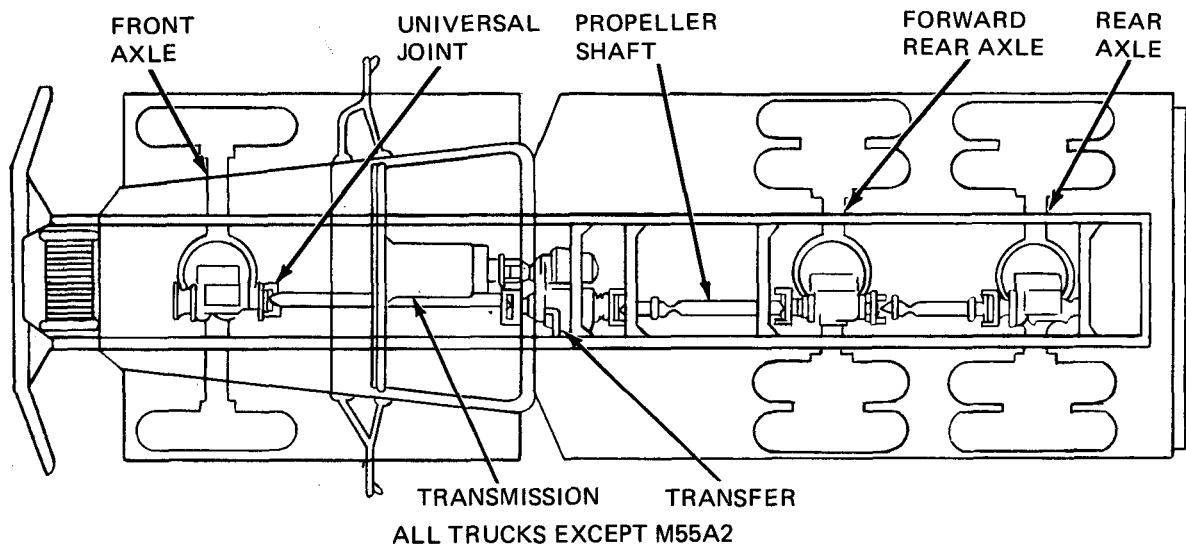

TA 116137

Figure 39-1. Propeller Shaft Arrangement (All Trucks Except M55A2)

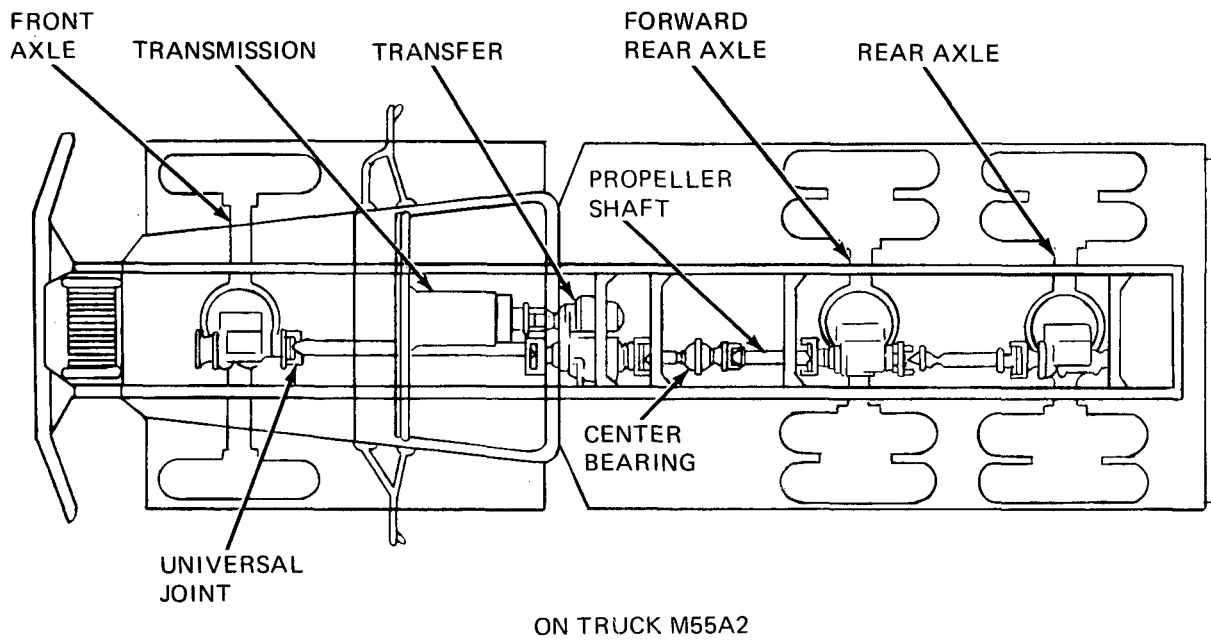

TA 116138

Figure 39-2. Propeller Shaft Arrangement (Truck M55A2)

CHAPTER 40

FRONT AXLE SYSTEM TROUBLESHOOTING

40-1. EQUIPMENT ITEMS COVERED. This chapter gives equipment troubleshooting procedures for the front axle system, for which there are authorized corrective maintenance tasks at the organizational maintenance level.

40-2. EQUIPMENT ITEMS NOT COVERED. All equipment items for which corrective maintenance is authorized at the organizational maintenance level are covered in this chapter.

FRONT AXLE SYSTEM TROUBLESHOOTING

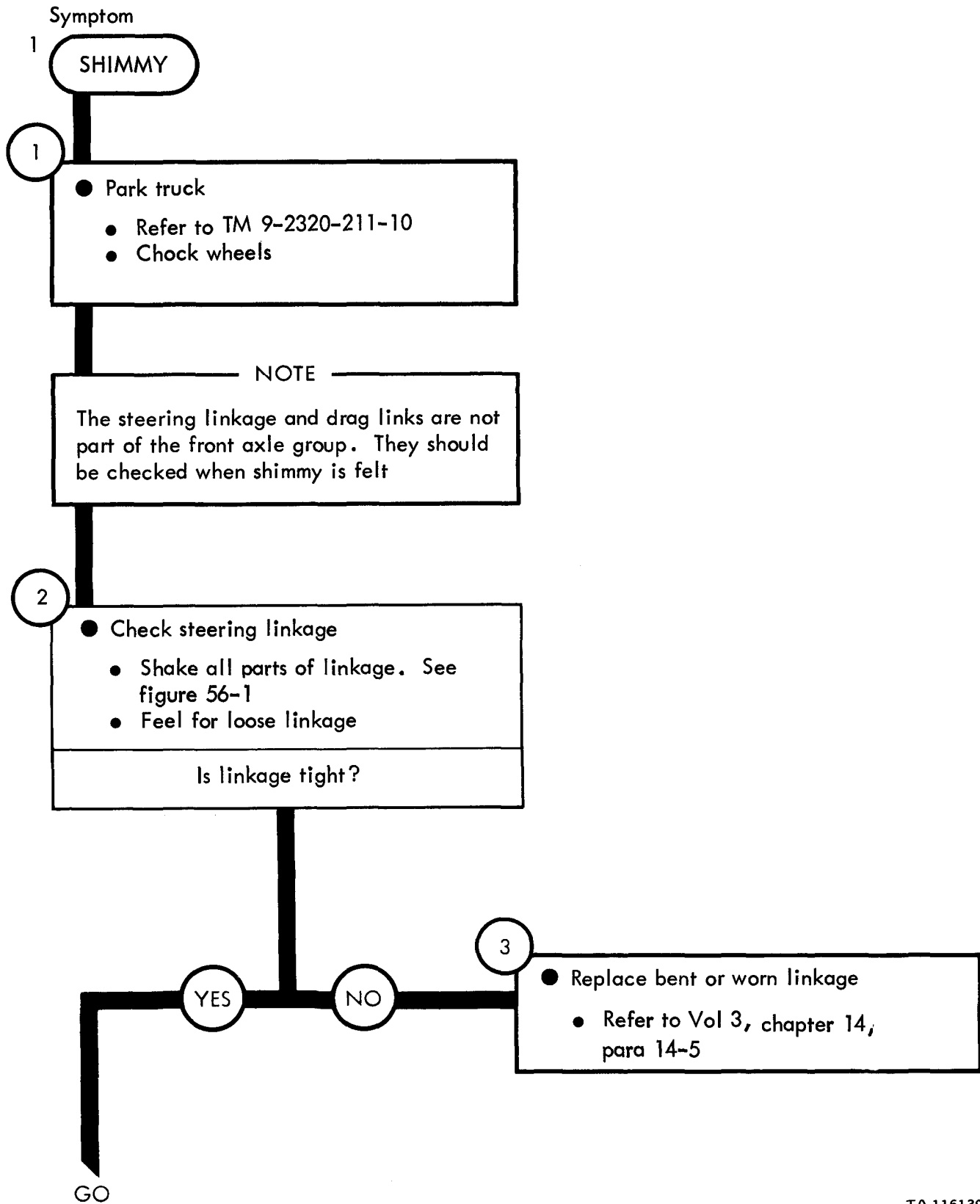

Figure 40-1 (Sheet 1 of 3)

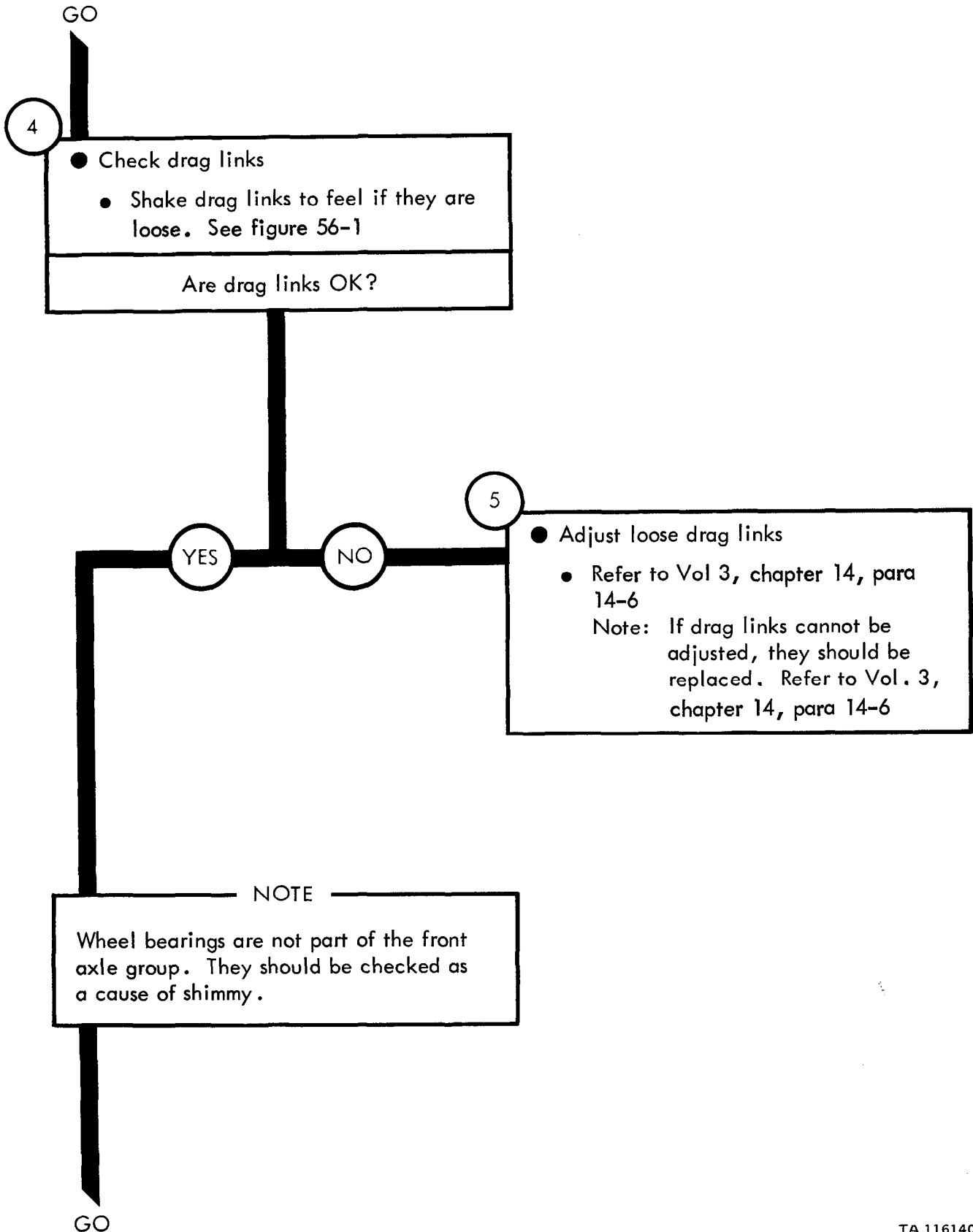

Figure 40-1 (Sheet 2 of 3)

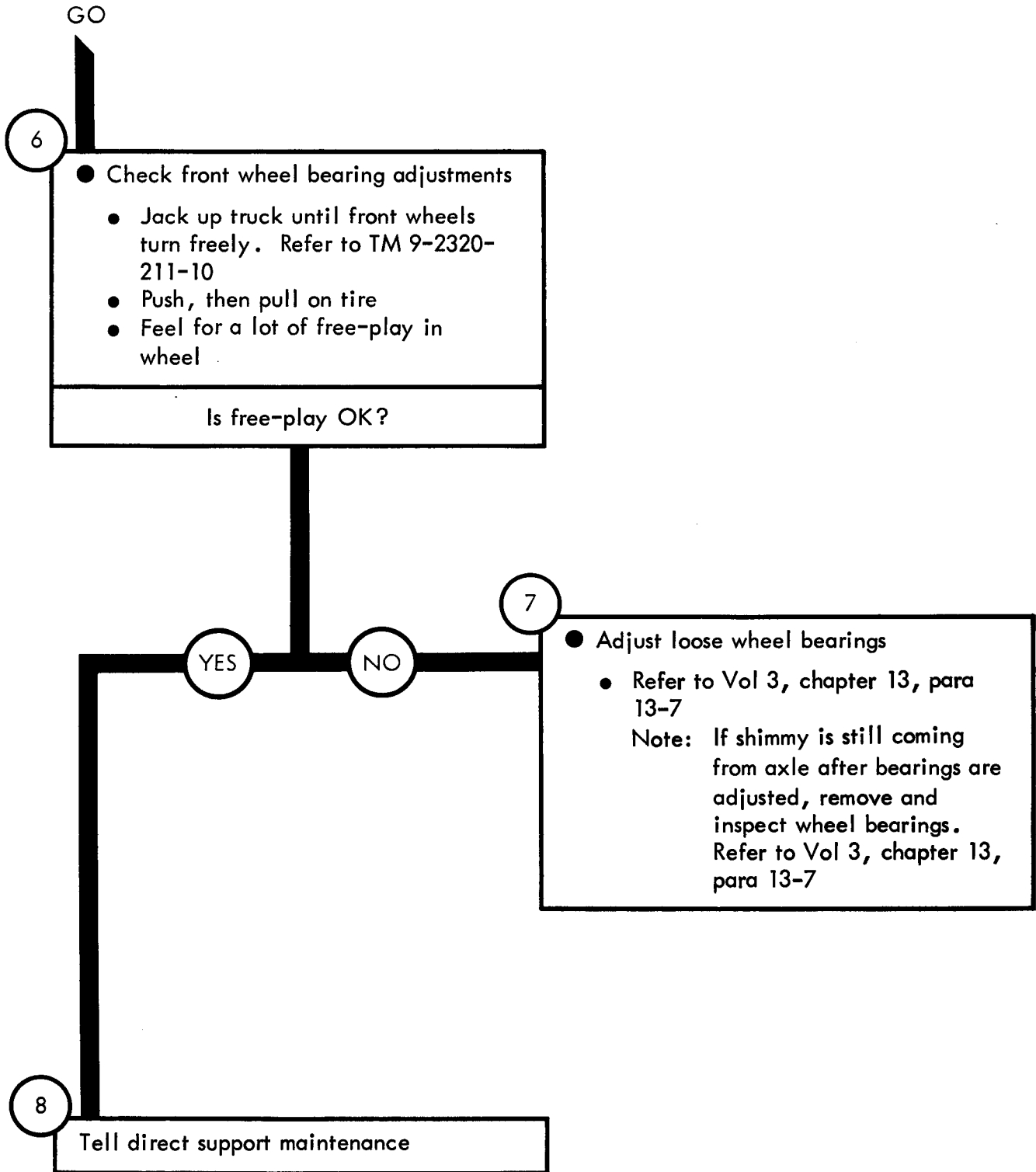

Figure 40-1 (Sheet 3 of 3)

Symptom

2

FRONT AXLE MAKES NOISE

1

- Make truck ready for work on front axle
 - Park truck. Refer to TM 9-2320-211-10
 - Chock wheels

NOTE

Wheel bearings are not part of the front axle group. They should be checked as a cause of front axle making noise.

2

- Check front wheel bearing adjustments
 - Jack up truck until front wheels turn freely. Refer to TM 9-2320-211-10
 - Push, then pull on tire
 - Feel for free play in wheel

NOTE: There should be very little free play in wheel

Is free-play OK?

GO

Figure 40-2 (Sheet 1 of 3)

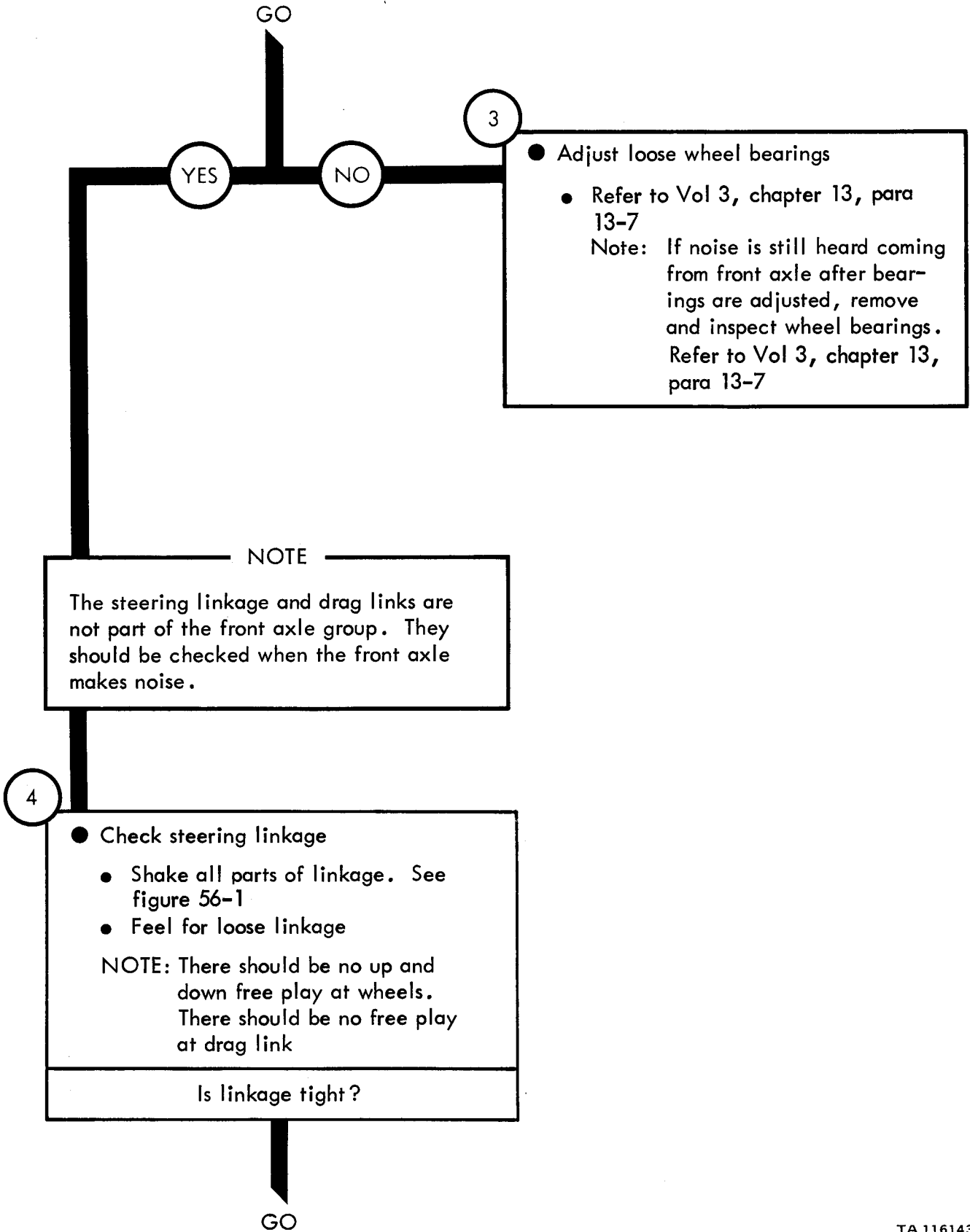

Figure 40-2 (Sheet 2 of 3)

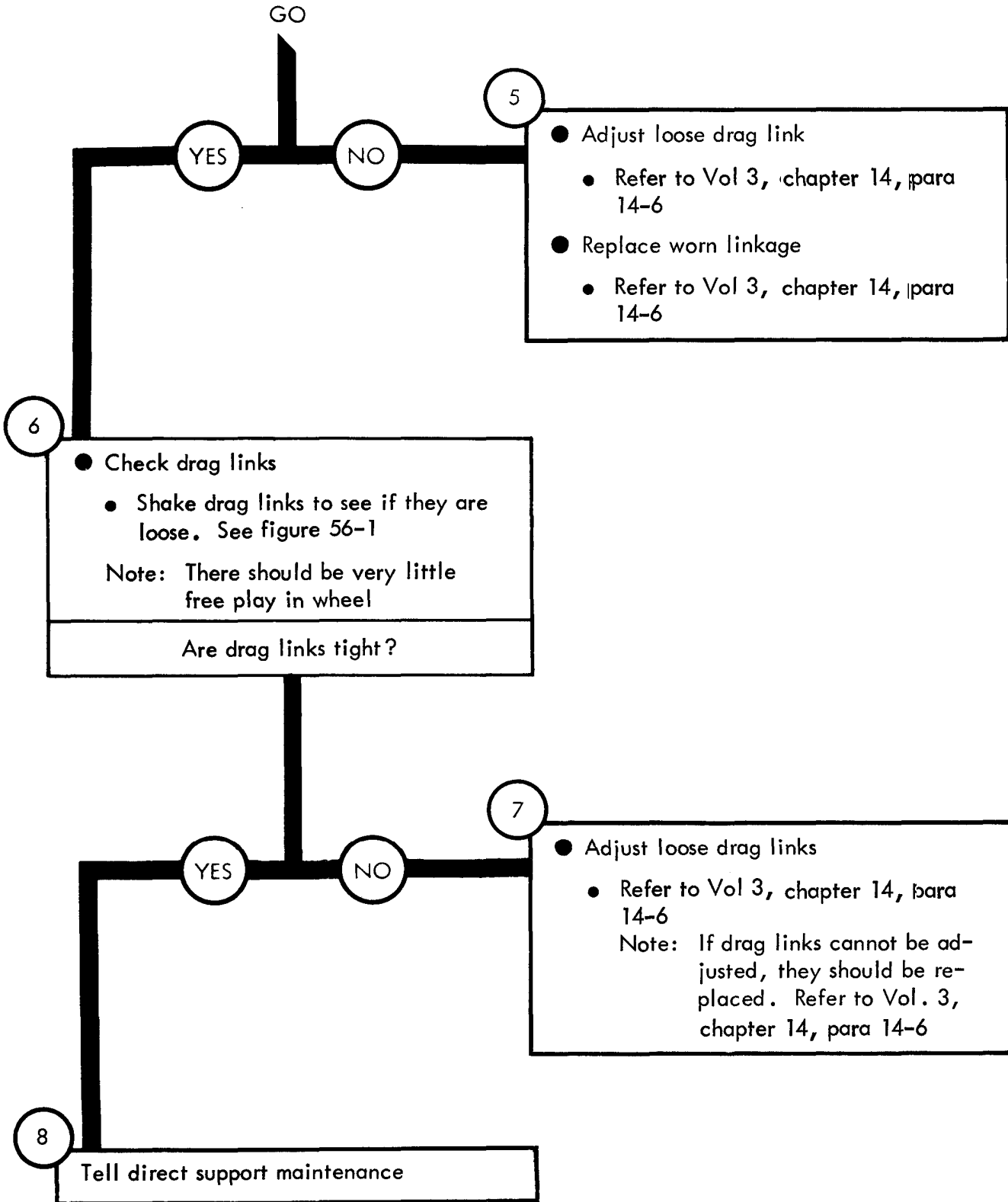

Figure 40-2 (Sheet 3 of 3)

TA 116144

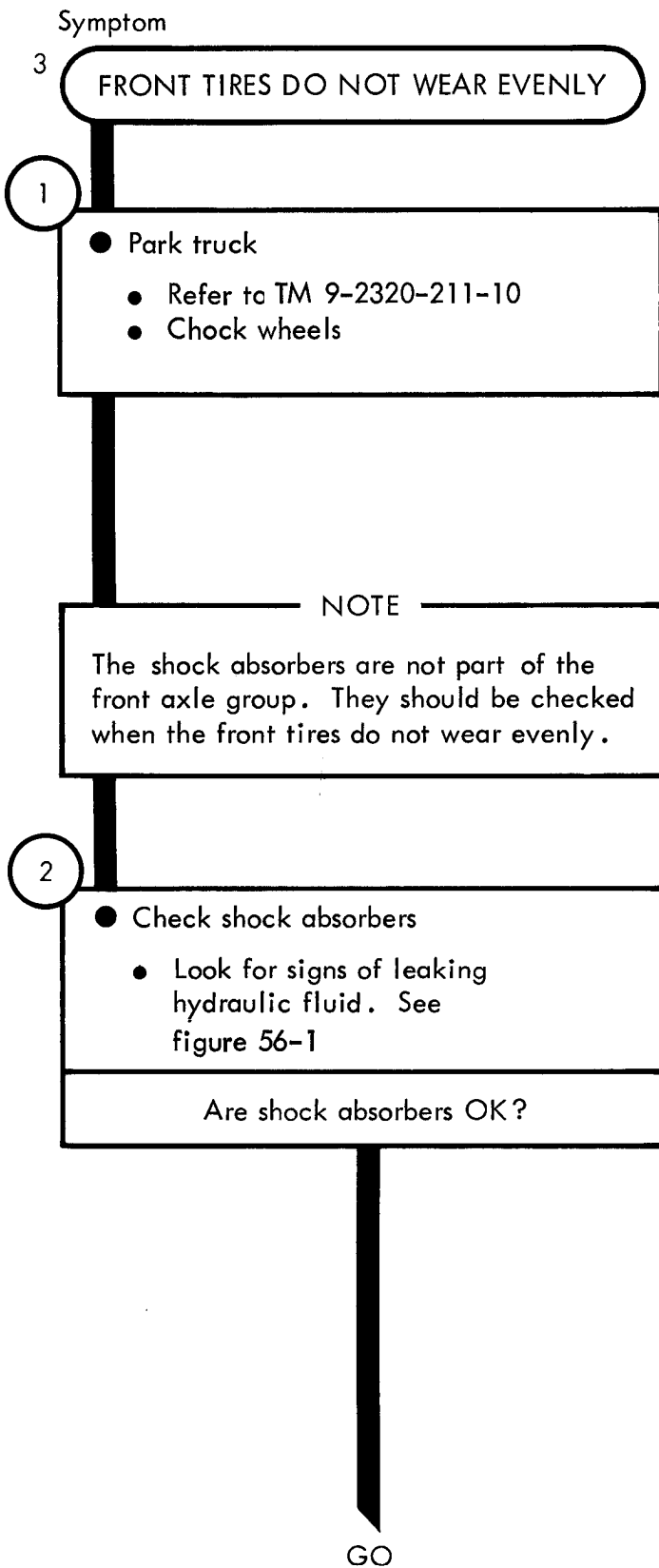

Figure 40-3 (Sheet 1 of 4)

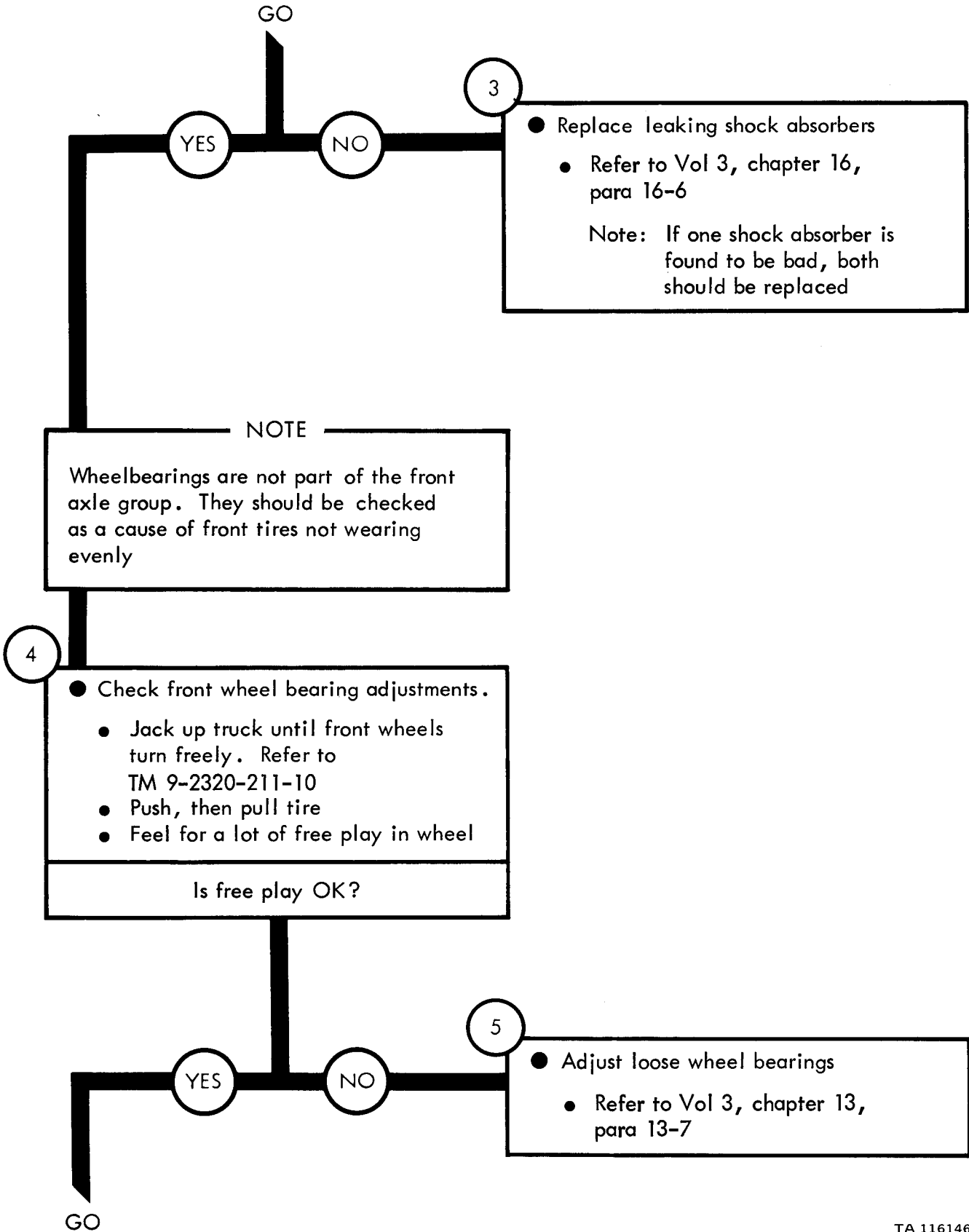

Figure 40-3 (Sheet 2 of 4)

TA 116146

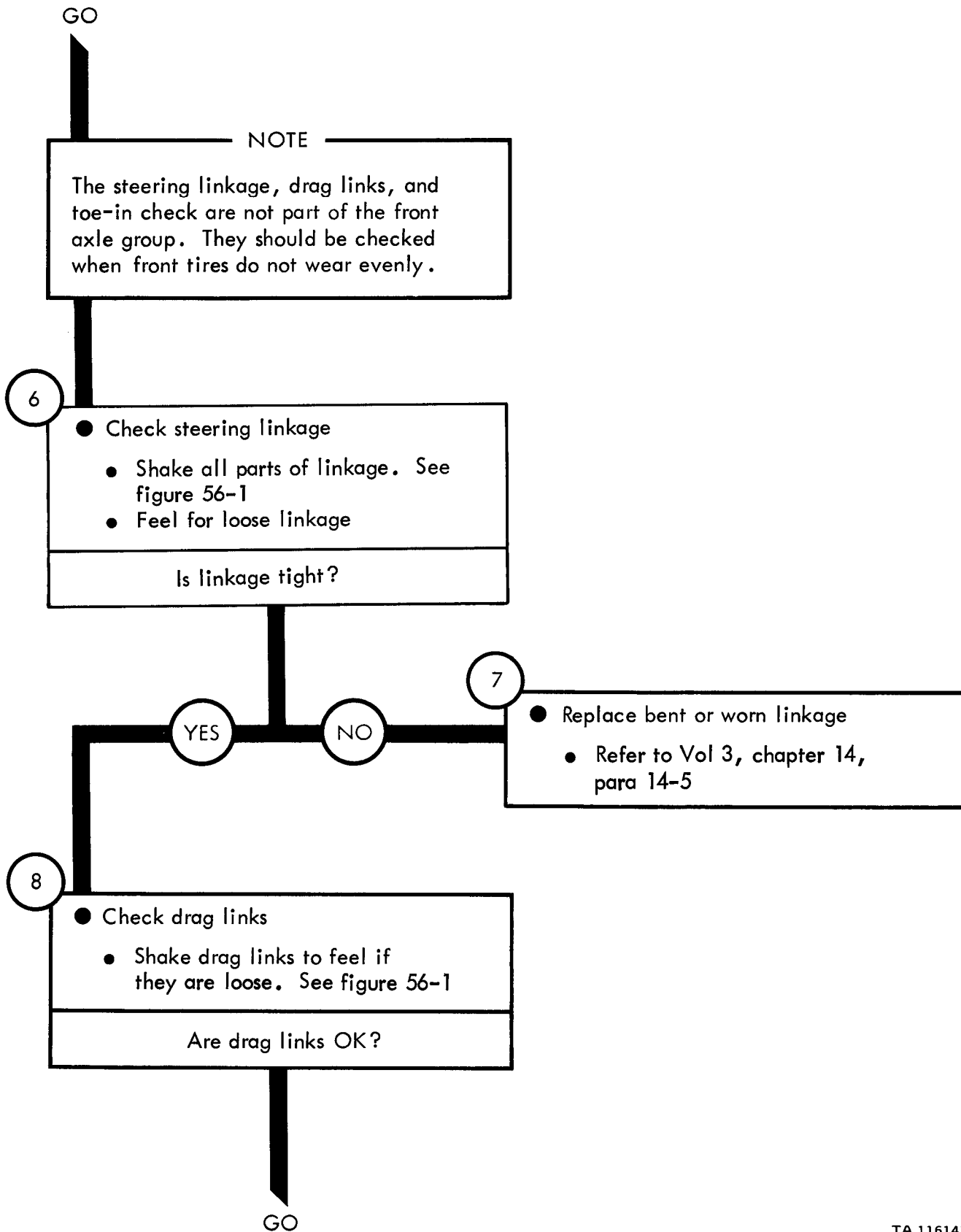

Figure 40-3 (Sheet 3 of 4)

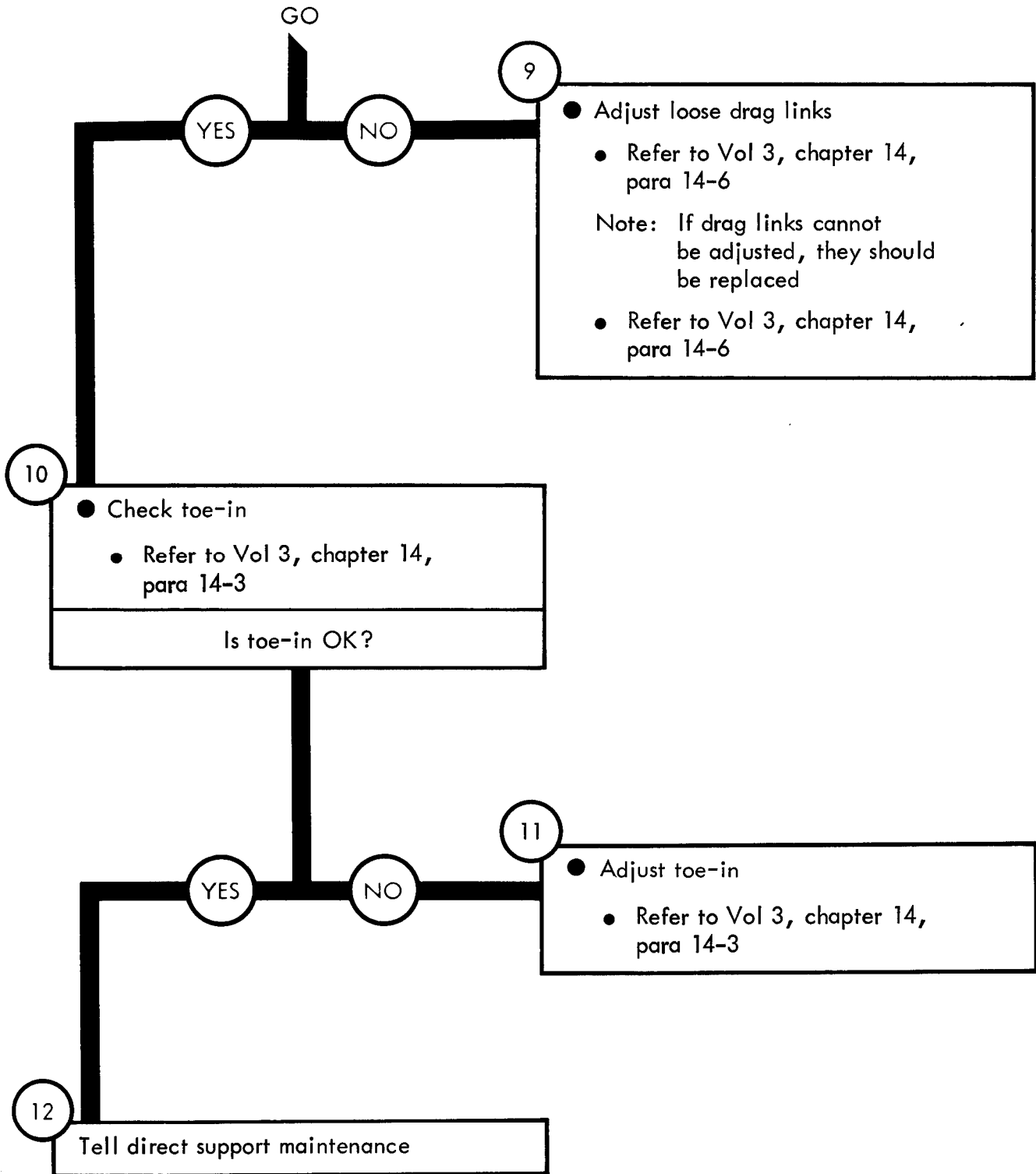
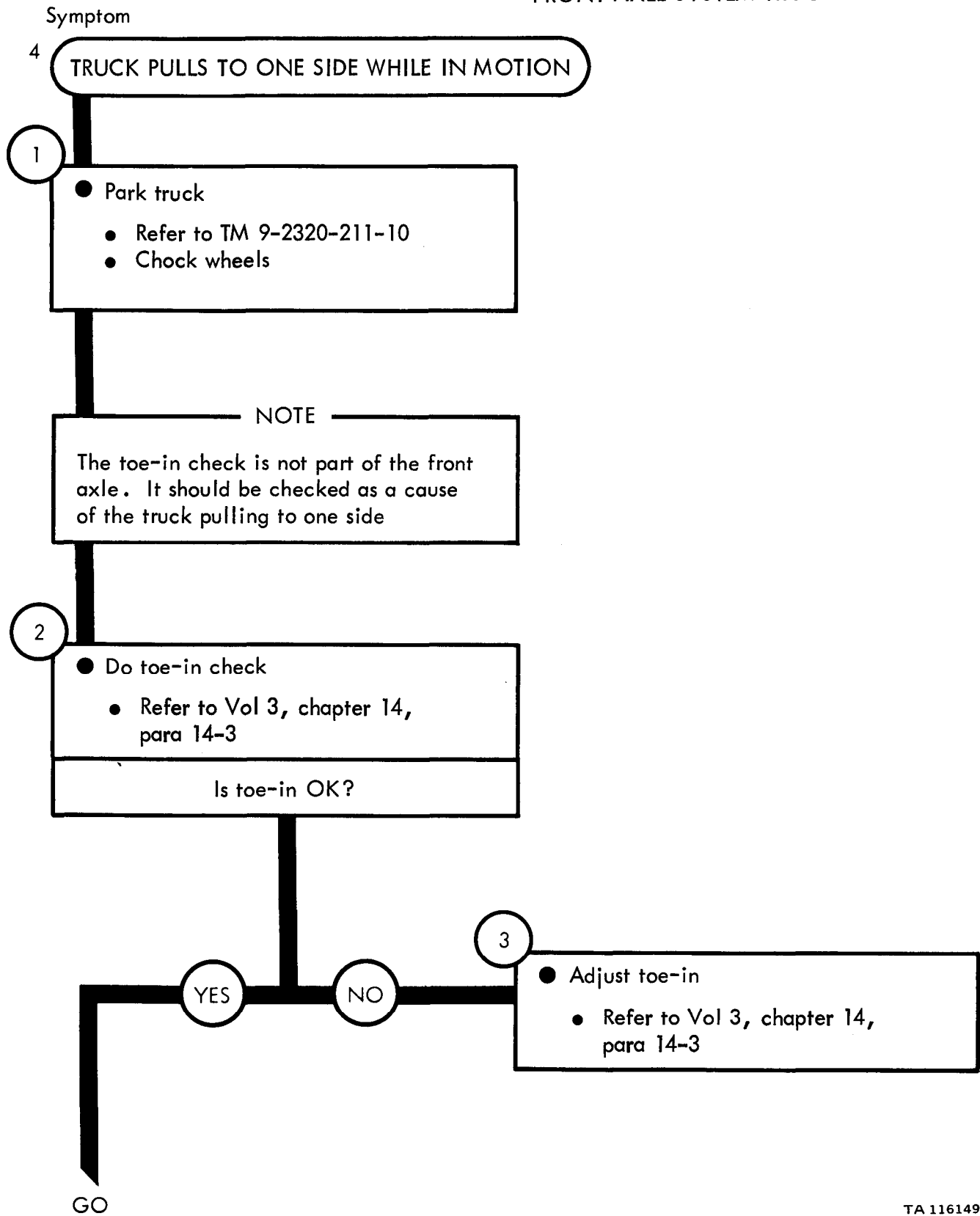

Figure 40-3 (Sheet 4 of 4)

TA 116148

FRONT AXLE SYSTEM TROUBLESHOOTING



TA 116149

Figure 40-4 (Sheet 1 of 3)

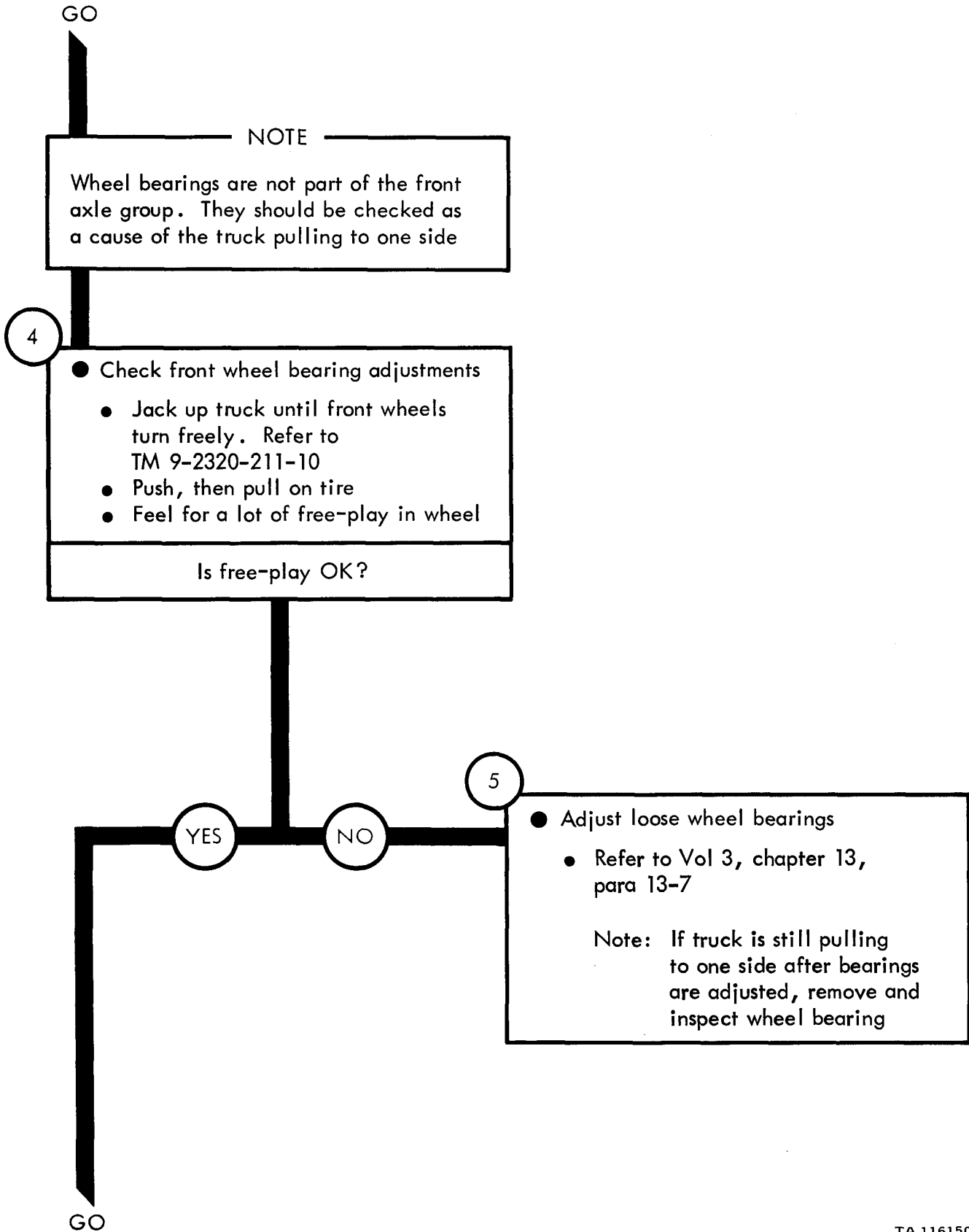

Figure 40-4 (Sheet 2 of 3)

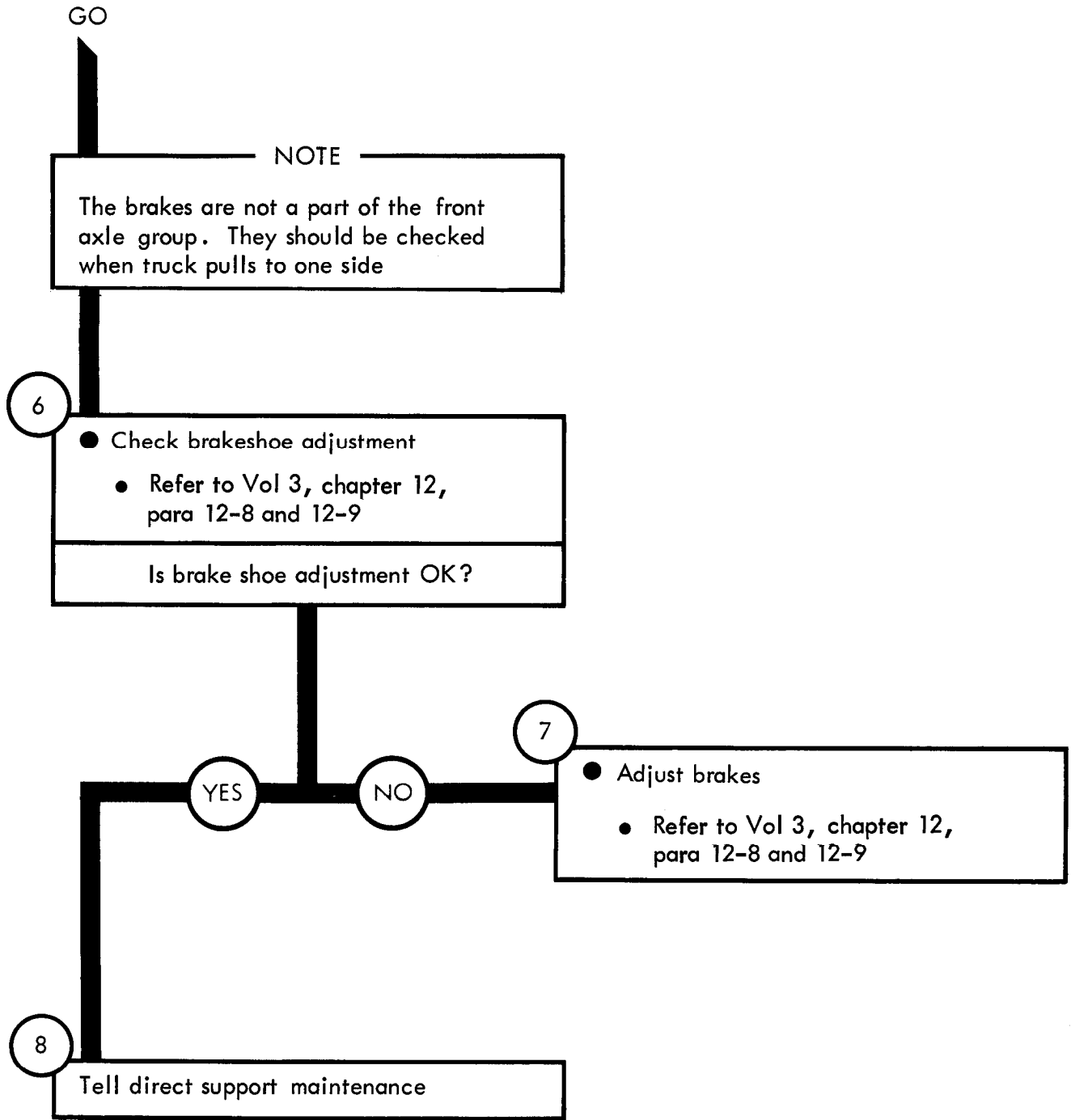

Figure 40-4 (Sheet 3 of 3)

CHAPTER 41

FRONT AXLE SYSTEM TROUBLESHOOTING SUMMARY

41-1. GENERAL. This chapter gives a summary of troubleshooting procedures given in chapter 40, for the Front Axle System.

41-2. PROCEDURES. The summary in this chapter covers all fault symptoms found in the detailed troubleshooting procedures in Part 1. Chapter 7 outlines a sample troubleshooting procedure. The summary procedures are based on the "what-to-do" portions of the detailed procedures and do not include the "How-to-do-it" instructions. Warnings, cautions, and notes are given where needed.

FRONT AXLE SYSTEM TROUBLESHOOTING SUMMARY

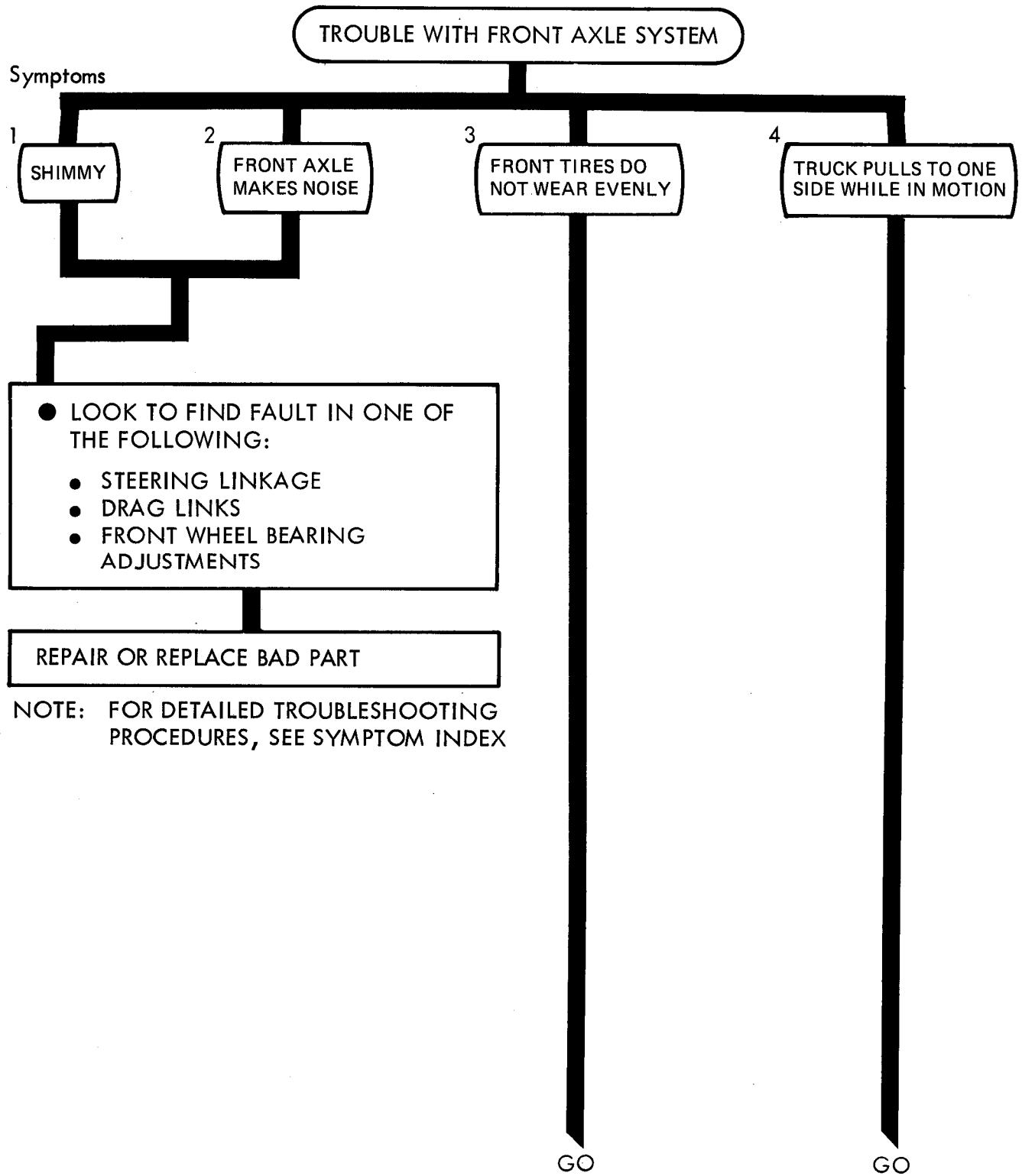

TA 116152

Figure 41-1 (Sheet 1 of 2)

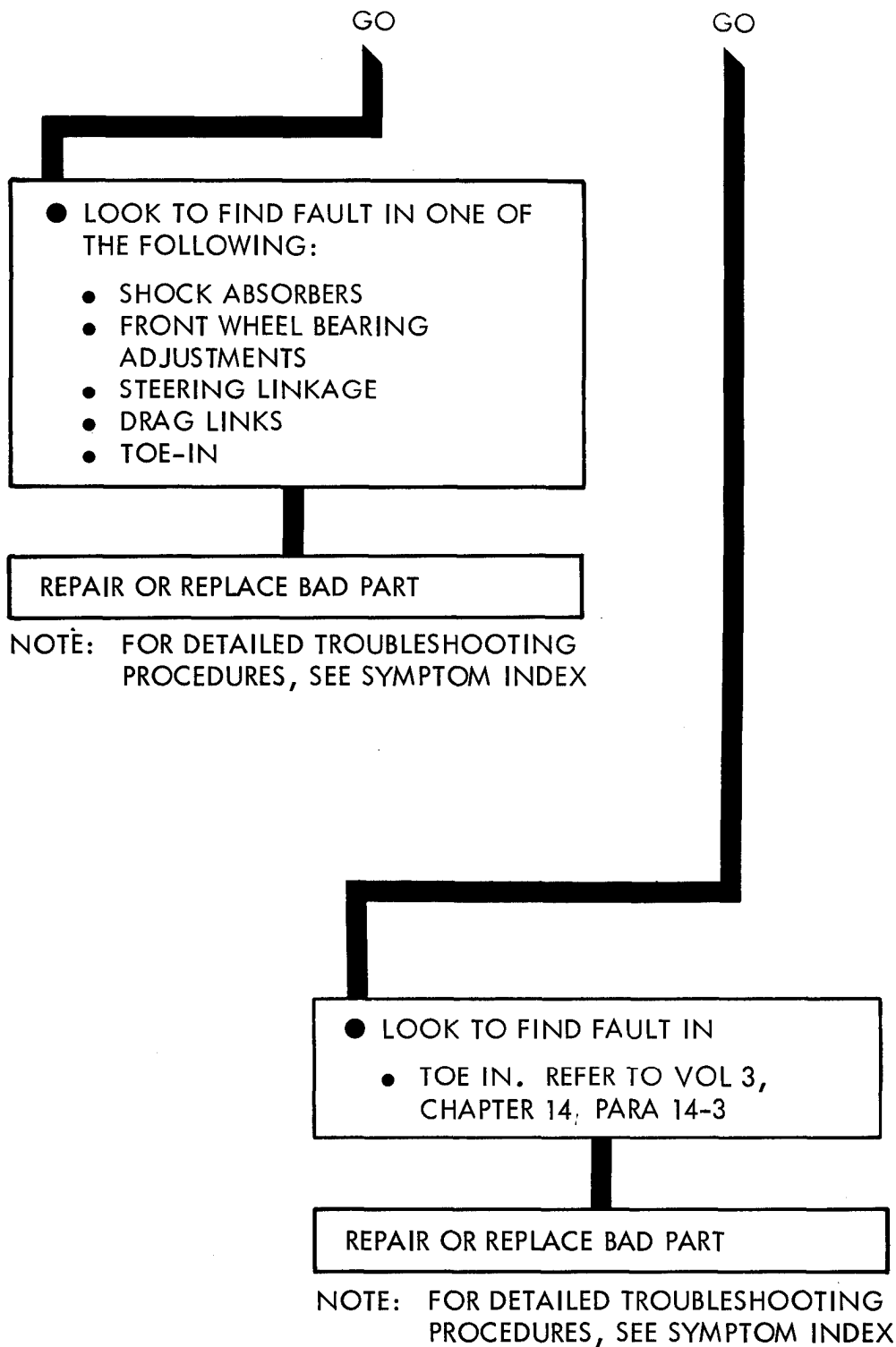

TA 116153

Figure 41-1 (Sheet 2 of 2)

CHAPTER 42

FRONT AXLE SYSTEM CHECKOUT PROCEDURES

42-1. GENERAL. This chapter gives procedures for checking out the system after troubleshooting and repair have been done. Procedures are set up in flow chart form showing the checkout steps in order and referring to the fault symptom index when the system does not check out.

FRONT AXLE SYSTEM CHECKOUT

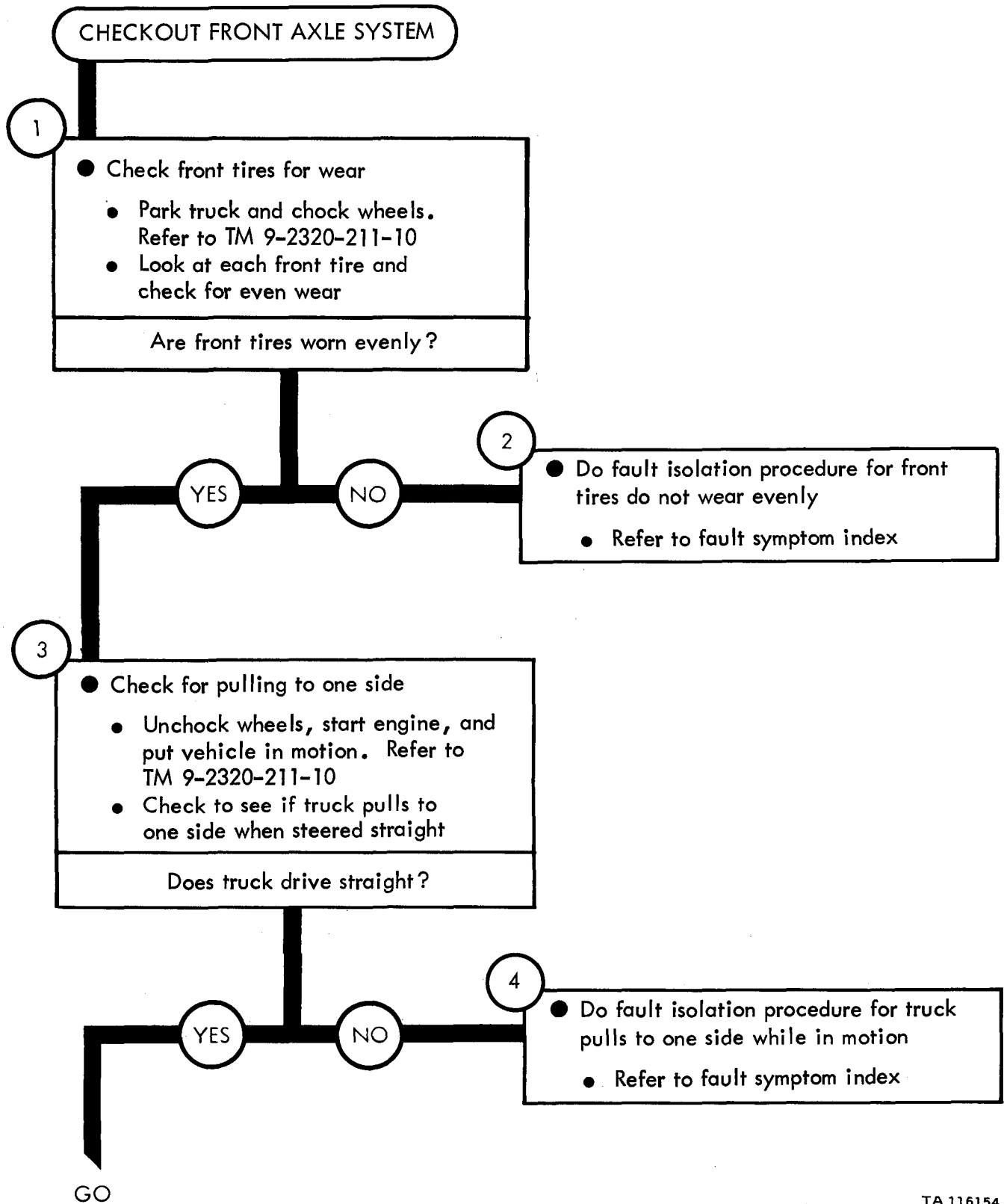
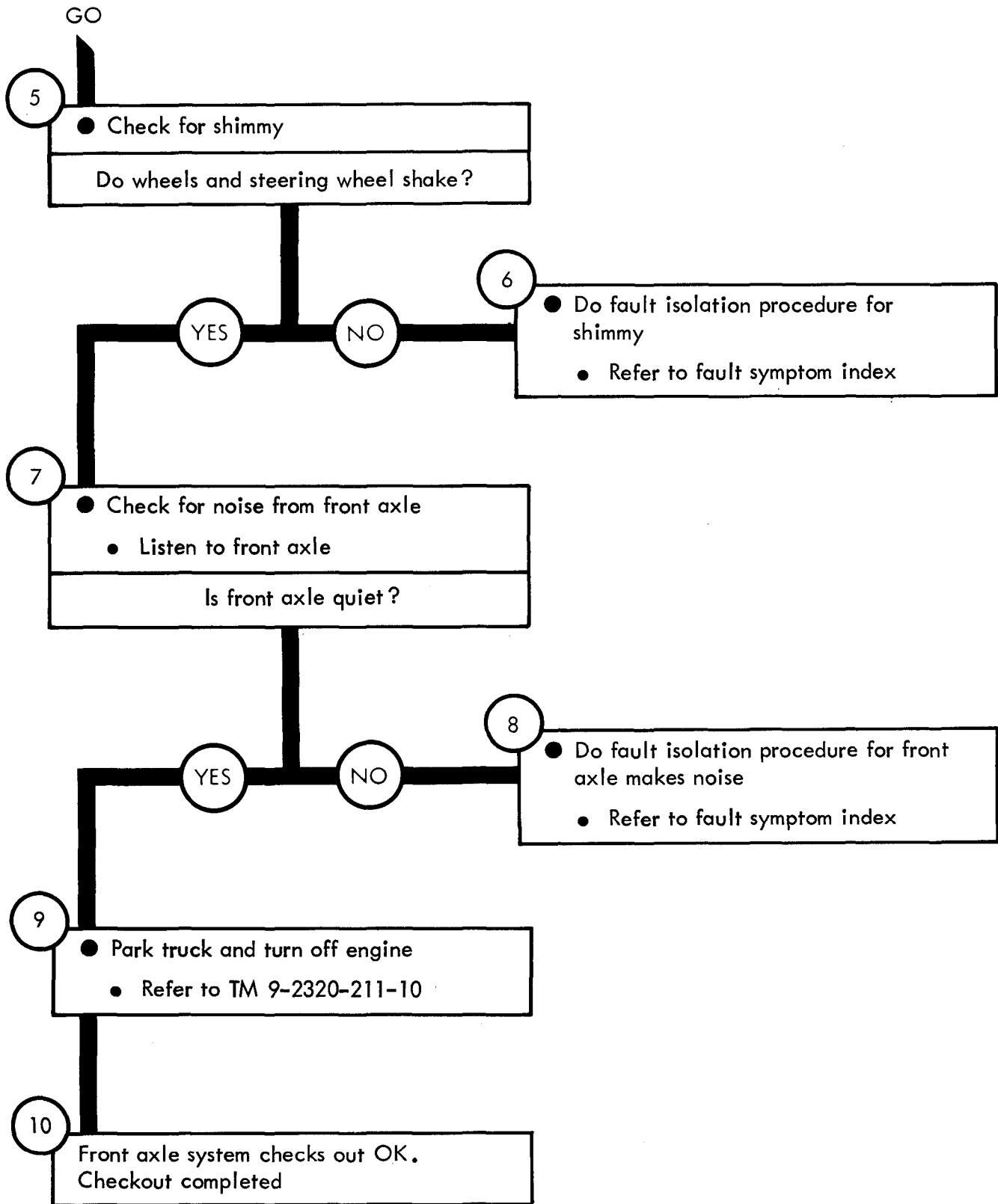

Figure 42-1 (Sheet 1 of 2)



TA 116155

Figure 42-1 (Sheet 2 of 2)

CHAPTER 43

REAR AXLE SYSTEM TROUBLESHOOTING

43-1. EQUIPMENT ITEMS COVERED. This chapter gives equipment troubleshooting procedures for the rear axle system, for which there are authorized corrective maintenance tasks at the organizational maintenance level.

43-2. EQUIPMENT ITEMS NOT COVERED. All equipment items for which corrective maintenance is authorized at the organizational maintenance level are covered in this chapter.

REAR AXLE SYSTEM TROUBLESHOOTING

Symptom

1 REAR AXLE MAKES NOISE

- 1
- Park truck
 - Refer to TM 9-2320-211-10

NOTE

Torque rods and spring seats are not part of the rear axle group. However, they should be checked as a cause of the rear axle making noise

- 2
- Check torque rods
 - Shake torque rods
 - Look for free play at torque rod ends
- NOTE: There should be no freeplay at torque rod ends
- Are torque rods OK?

GO

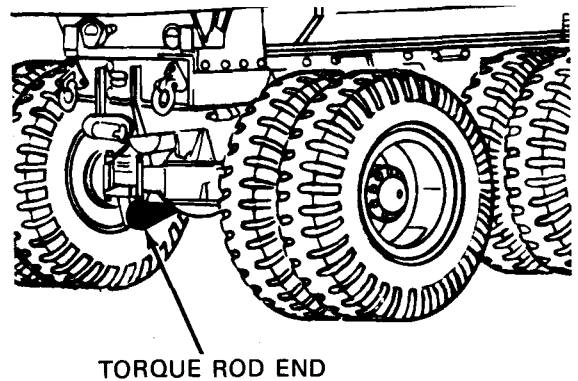

Figure 43-1 (Sheet 1 of 4)

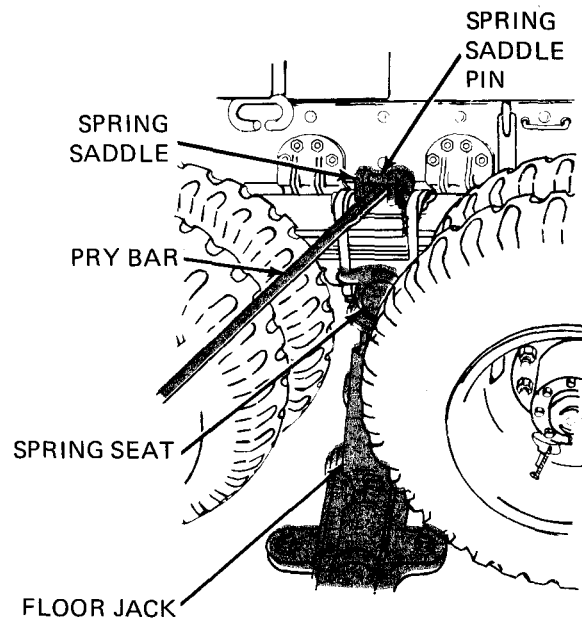
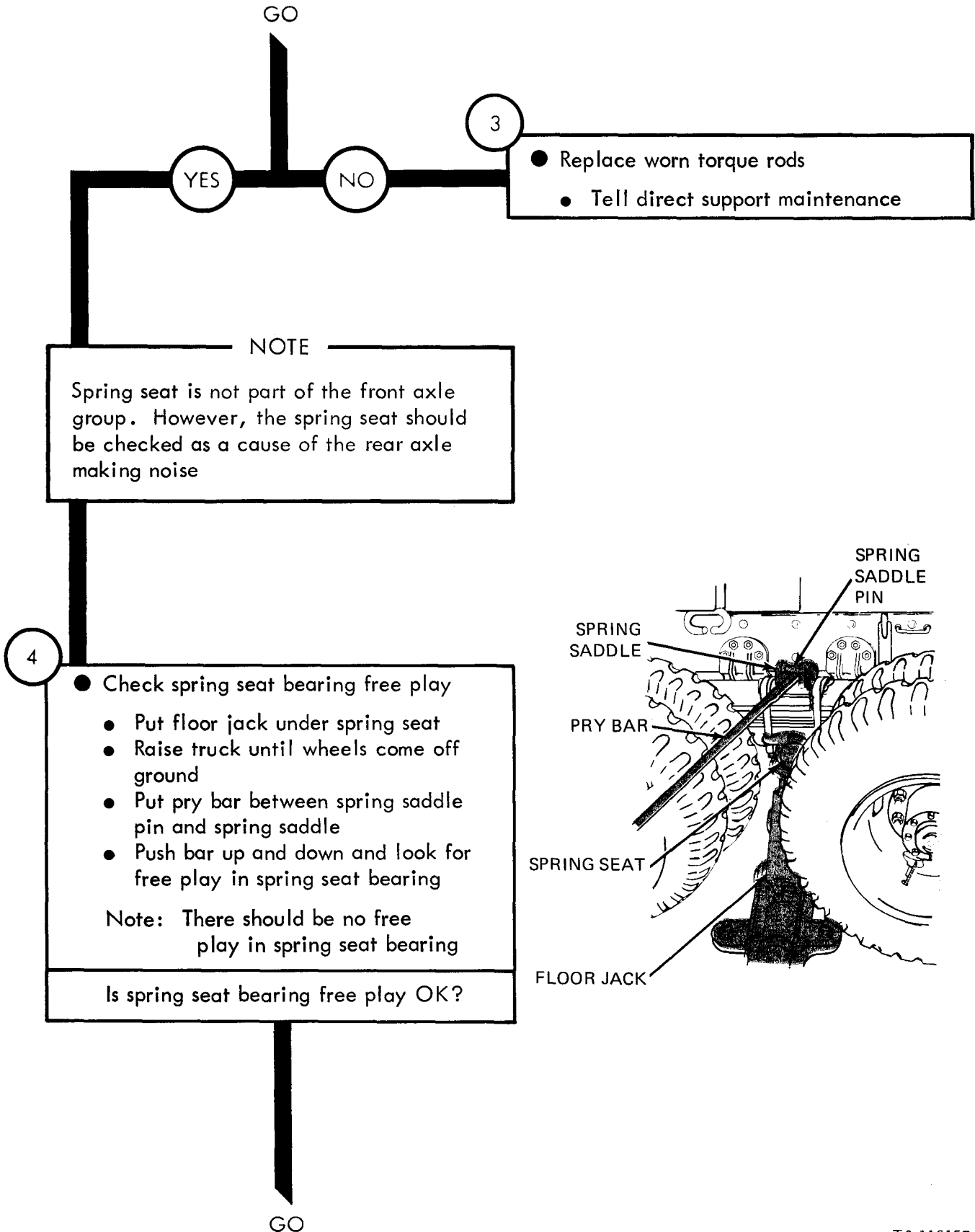

Figure 43-1 (Sheet 2 of 4)

TA 116157

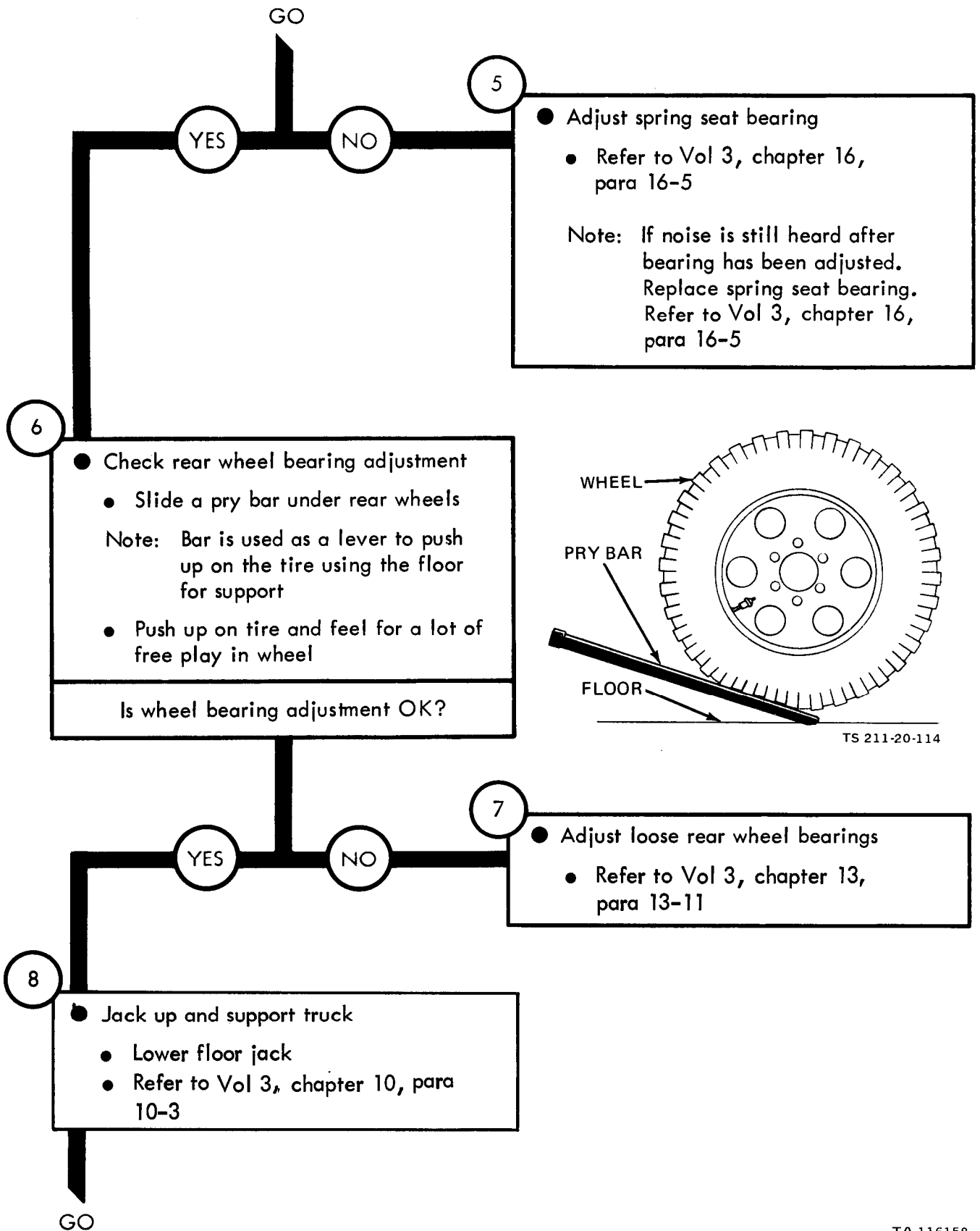
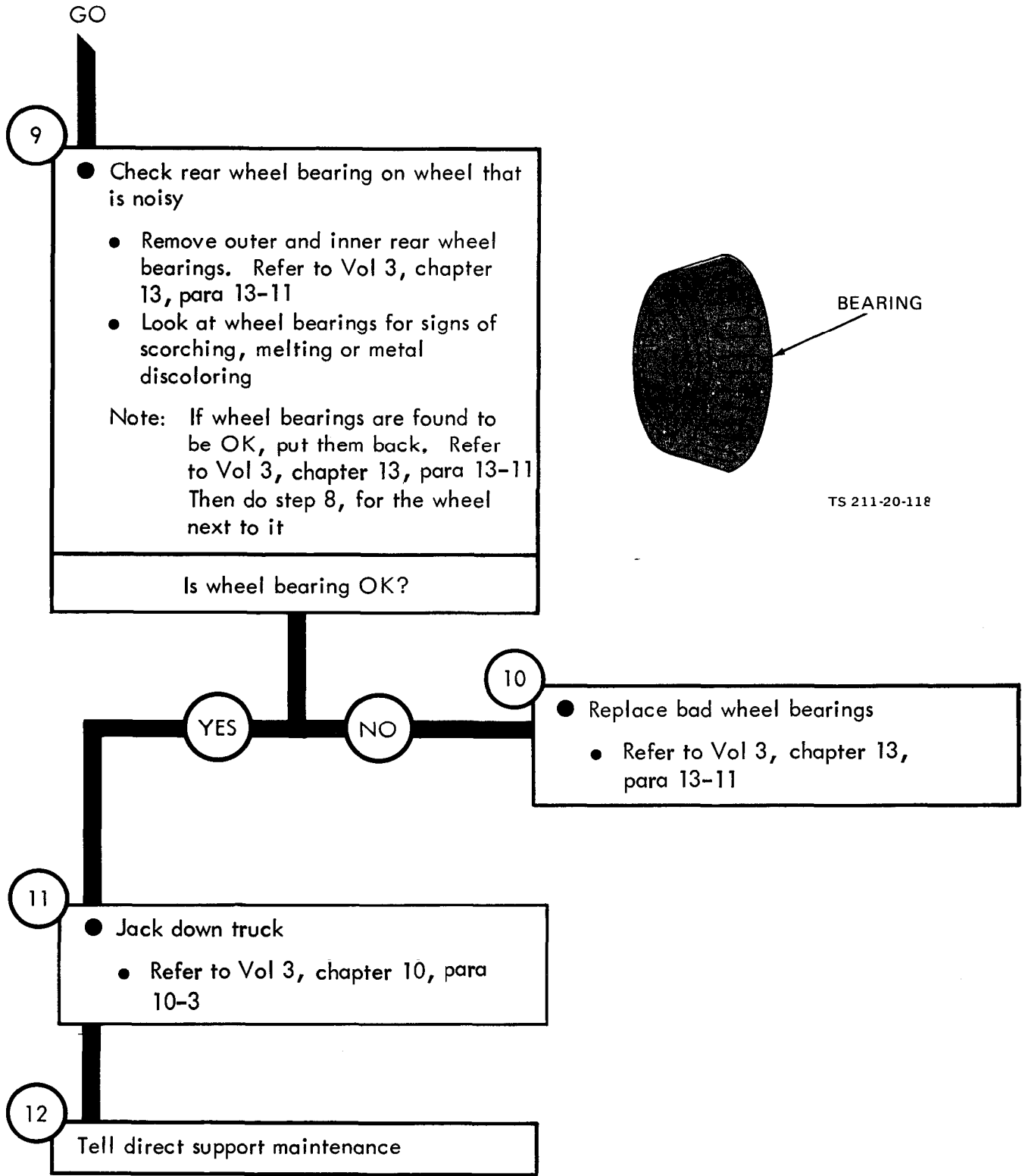
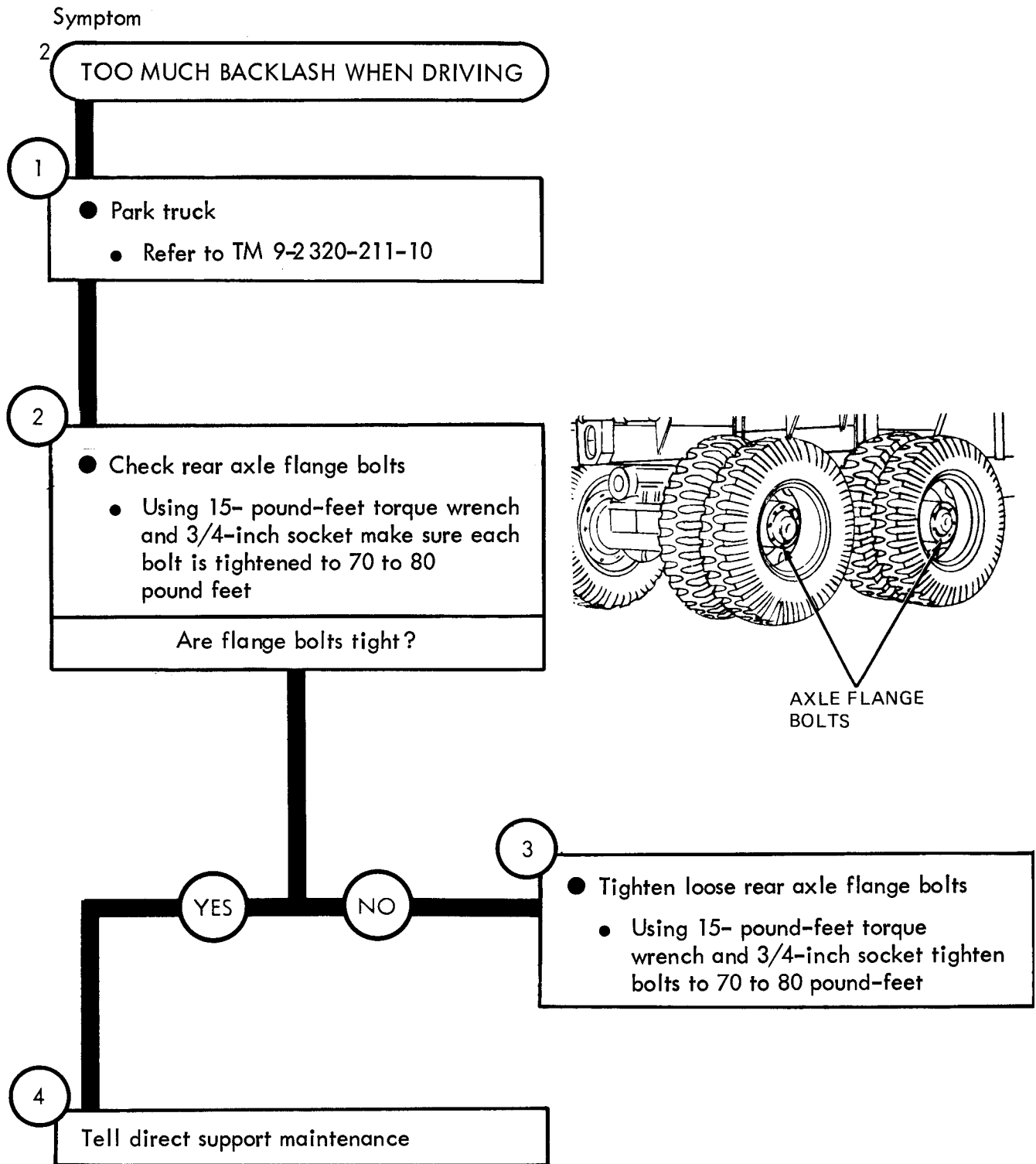

Figure 43-1 (Sheet 3 of 4)



TA 116159

Figure 43-1 (Sheet 4 of 4)



TA 116160

Figure 43-2

CHAPTER 44

REAR AXLE SYSTEM TROUBLESHOOTING SUMMARY

44-1. GENERAL. This chapter gives a summary of troubleshooting procedures given in chapter 43, for the Rear Axle System.

44-2. PROCEDURES. The summary in this chapter covers all fault symptoms found in the detailed troubleshooting procedures in Part 1. Chapter 7 outlines a sample troubleshooting procedure. The summary procedures are based on the "what-to-do" portions of the detailed procedures and do not include the "How-to-do-it" instructions. Warnings, cautions, and notes are given where needed.

REAR AXLE SYSTEM TROUBLESHOOTING SUMMARY

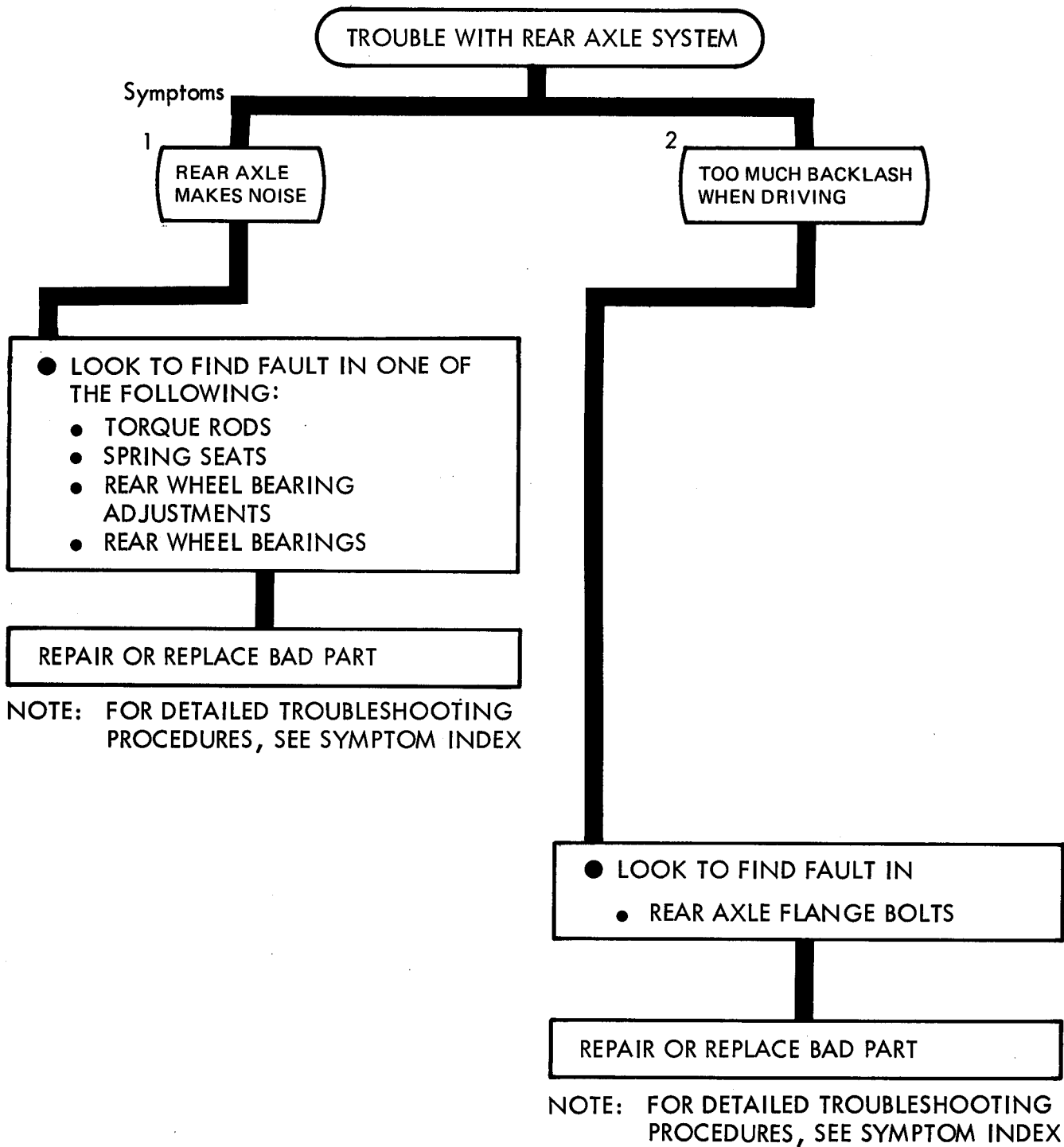

Figure 44-1

CHAPTER 45

REAR AXLE SYSTEM CHECKOUT PROCEDURES

45-1. GENERAL. This chapter gives procedures for checking out the system after troubleshooting and repair have been done. Procedures are set up in flow chart form showing the checkout steps in order and referring to the fault symptom index when the system does not checkout.

REAR AXLE SYSTEM CHECKOUT

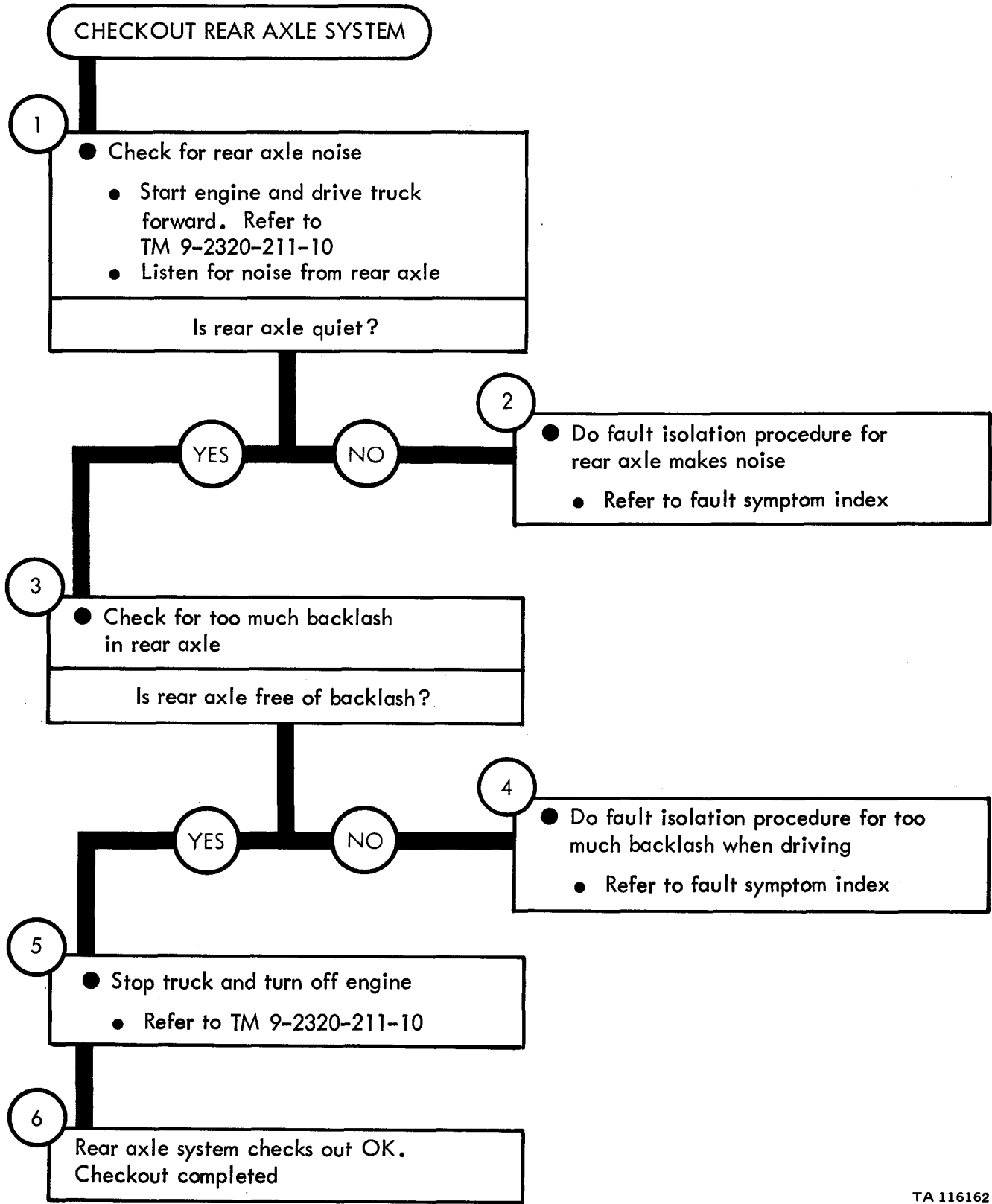

Figure 45-1

TA 116162

CHAPTER 46

BRAKE SYSTEM TROUBLESHOOTING

46-1. EQUIPMENT ITEMS COVERED . This chapter gives equipment troubleshooting procedures for the brake system, for which there are authorized corrective maintenance tasks at the organizational maintenance level.

46-2. EQUIPMENT ITEMS NOT COVERED . All equipment items for which corrective maintenance is authorized at the organizational maintenance level are covered in this chapter.

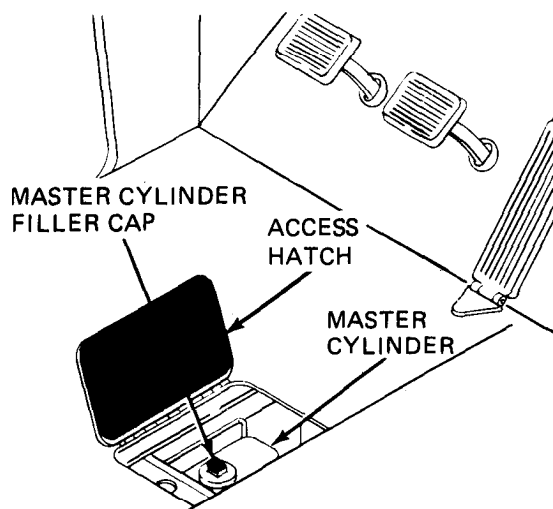
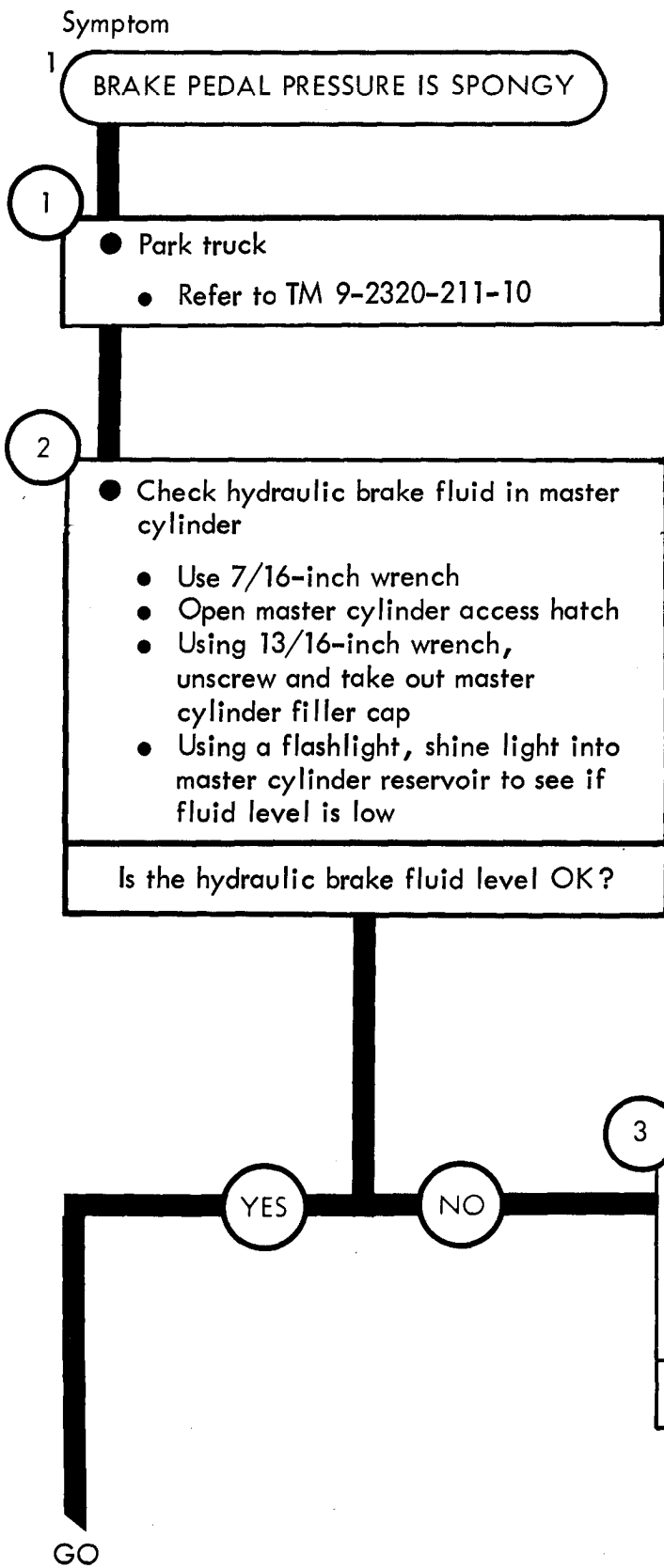

TS 211-20-21

TA 116163

Figure 46-1 (Sheet 1 of 8)

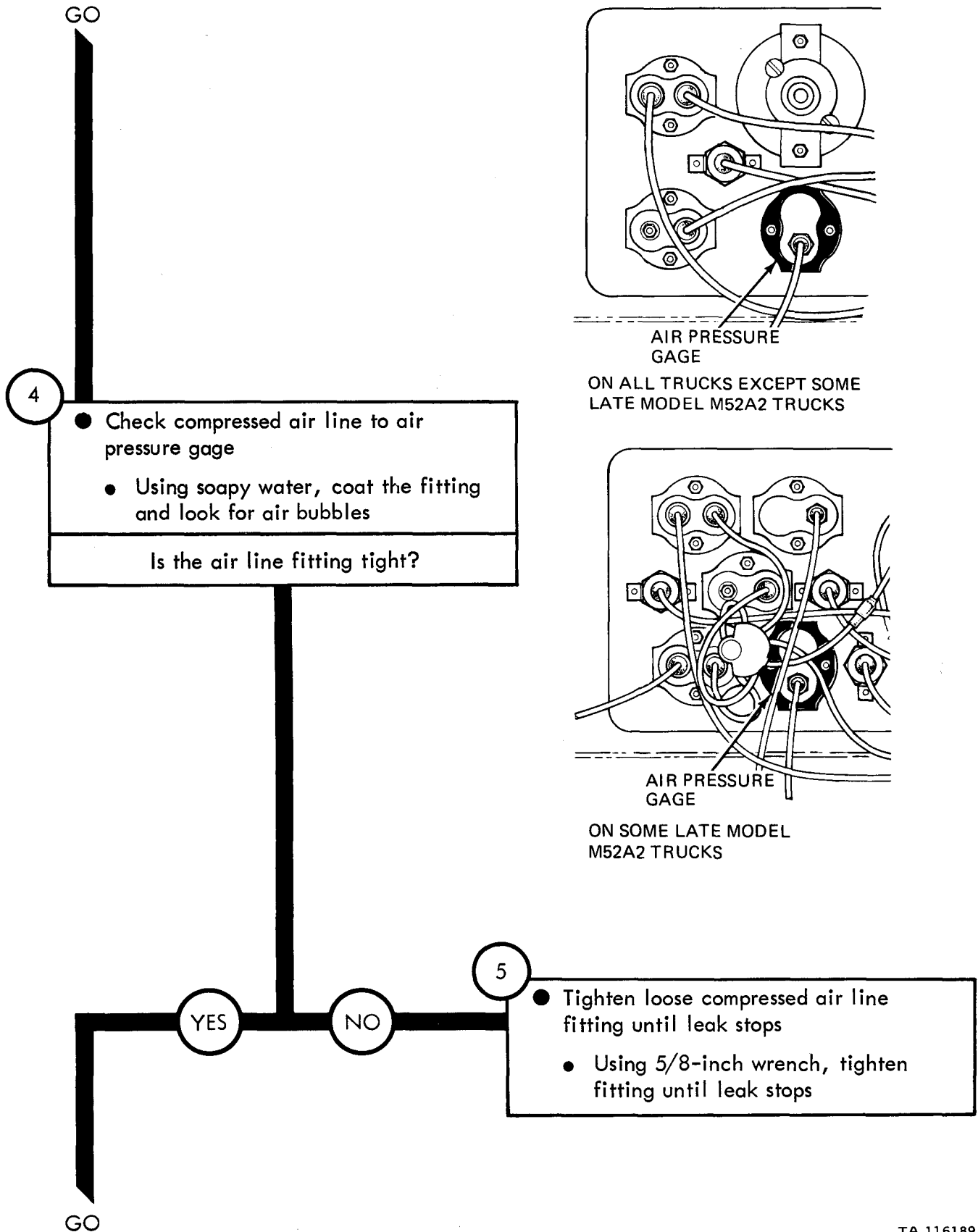

Figure 46-7 (Sheet 2 of 5)

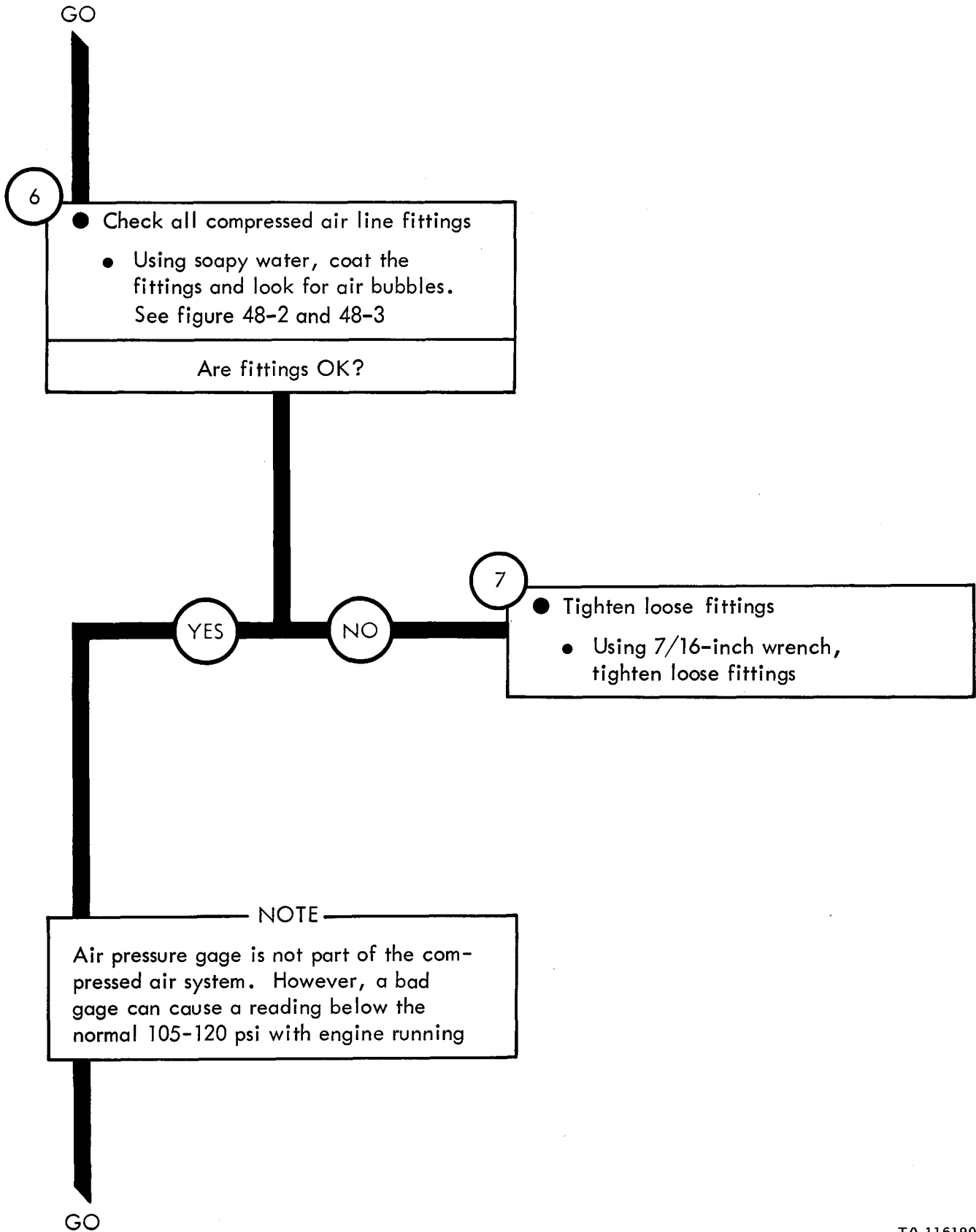

Figure 46-7 (Sheet 3 of 5)

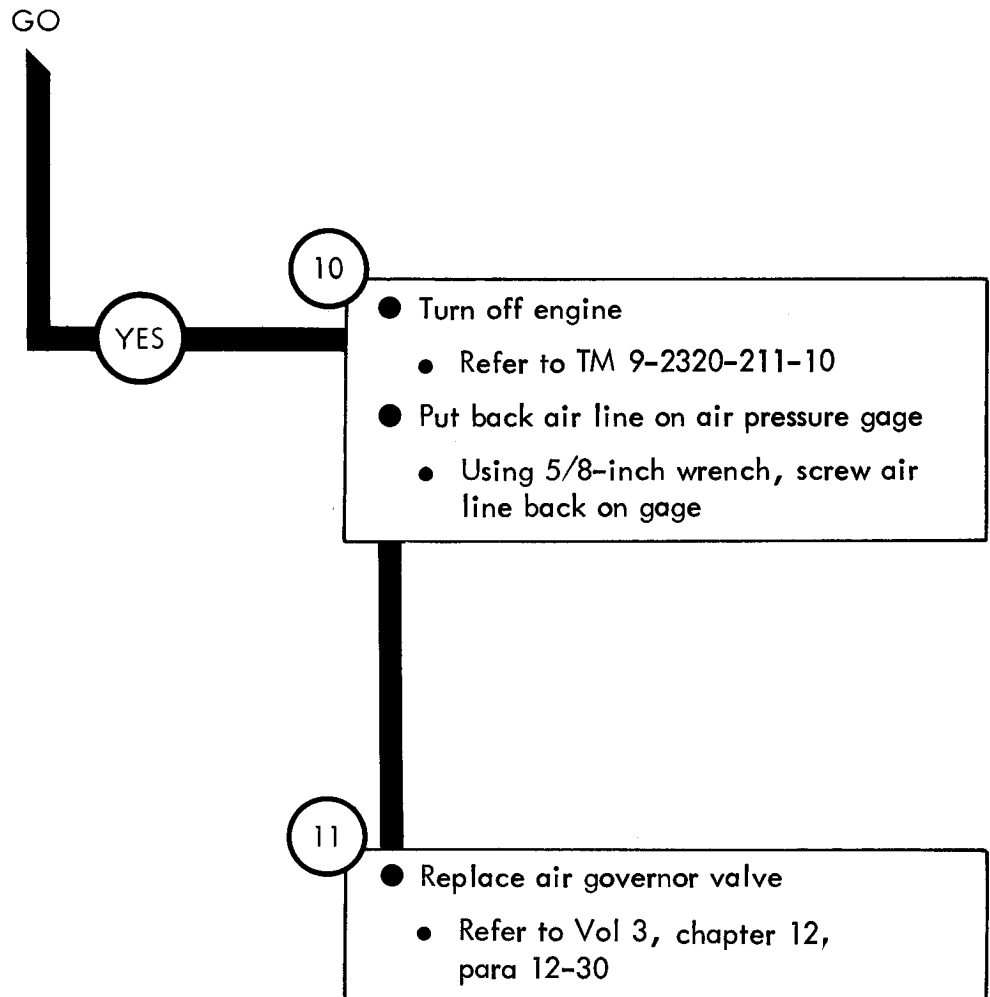

Figure 46-7 (Sheet 5 of 5)

Symptom

8 READING ON AIR PRESSURE GAGE IS ABOVE NORMAL

- 1
- Park truck and turn off engine
 - Refer to TM 9-2320-211-10

- 2
- Check air pressure gage
 - Open air reservoir drain valve
 - Using 5/8 inch wrench unscrew and take off air line from gage
 - Put air line on gage that is known to be good and tighten line using 5/8 inch wrench

GO

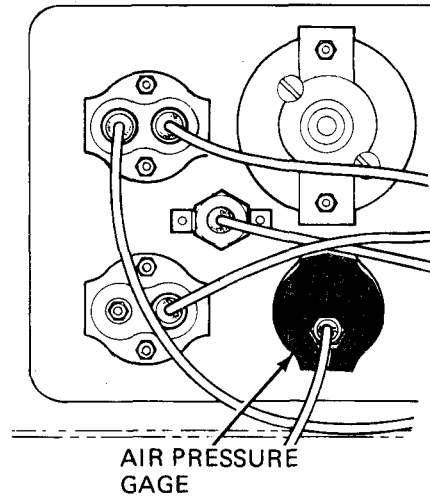

AIR PRESSURE GAGE

ON ALL TRUCKS EXCEPT SOME LATE MODEL M52A2 TRUCKS

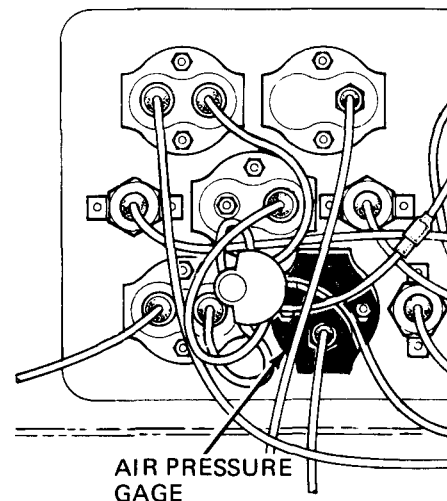

AIR PRESSURE GAGE

ON SOME LATE MODEL M52A2 TRUCKS

Figure 46-8 (Sheet 1 of 3)

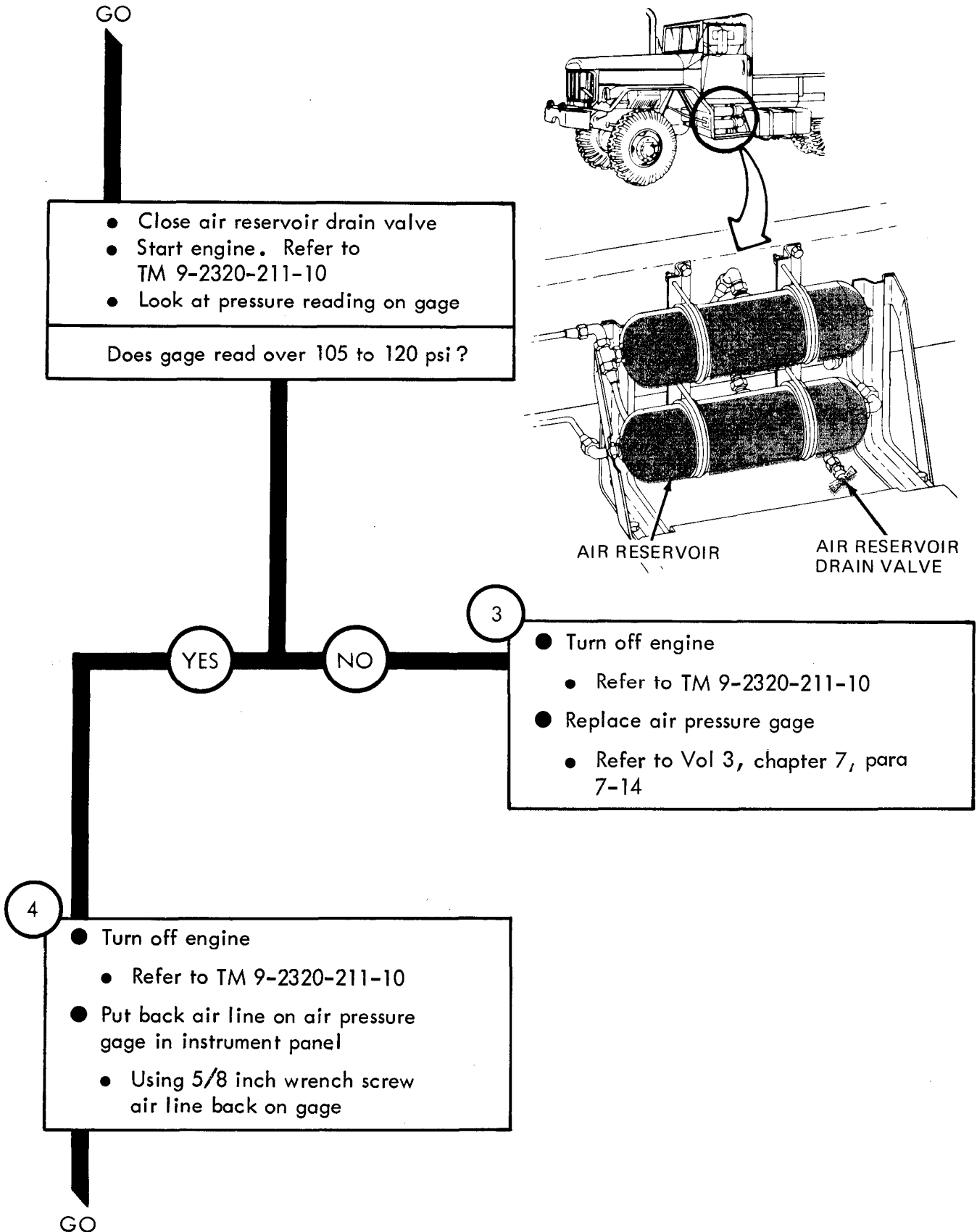

Figure 46-8 (Sheet 2 of 3)

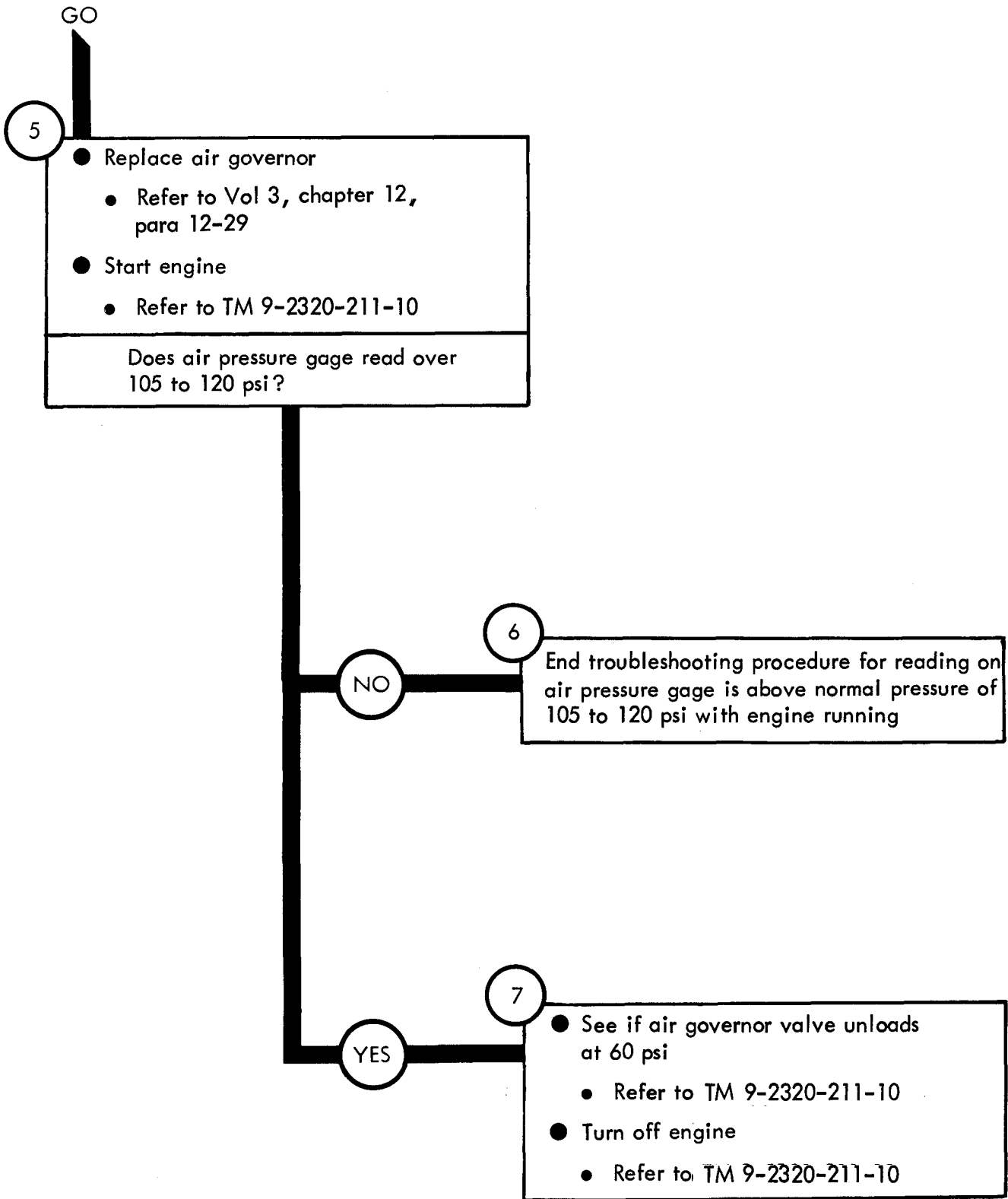

Figure 46-8 (Sheet 3 of 3)

Symptom

9 TRAILER BRAKES DO NOT WORK WHEN PEDAL IS PRESSED OR HAND CONTROL VALVE IS USED

1

- Park truck
 - Refer to TM 9-2320-211-10

2

- Check trailer brake compressed air lines, fittings, and service coupling
 - Turn on trailer brake hand control lever. Refer to TM 9-2320-211-10
 - Using soap suds, check for leaks. See figure 48-3
 - Look for crushed or broken lines. See figure 48-3

Are air lines, fittings, and coupling OK?

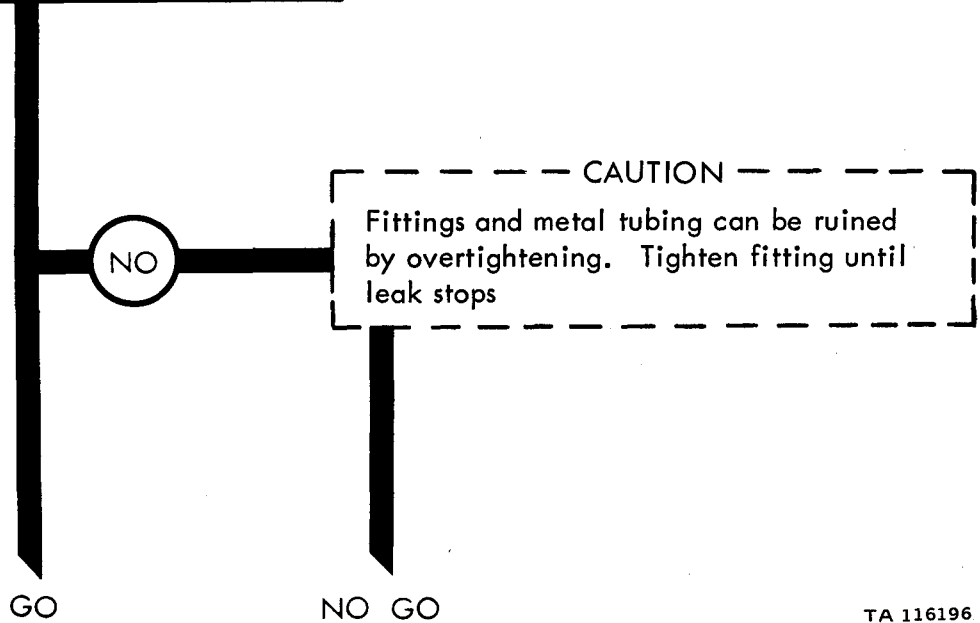

Figure 46-9 (Sheet 1 of 2)

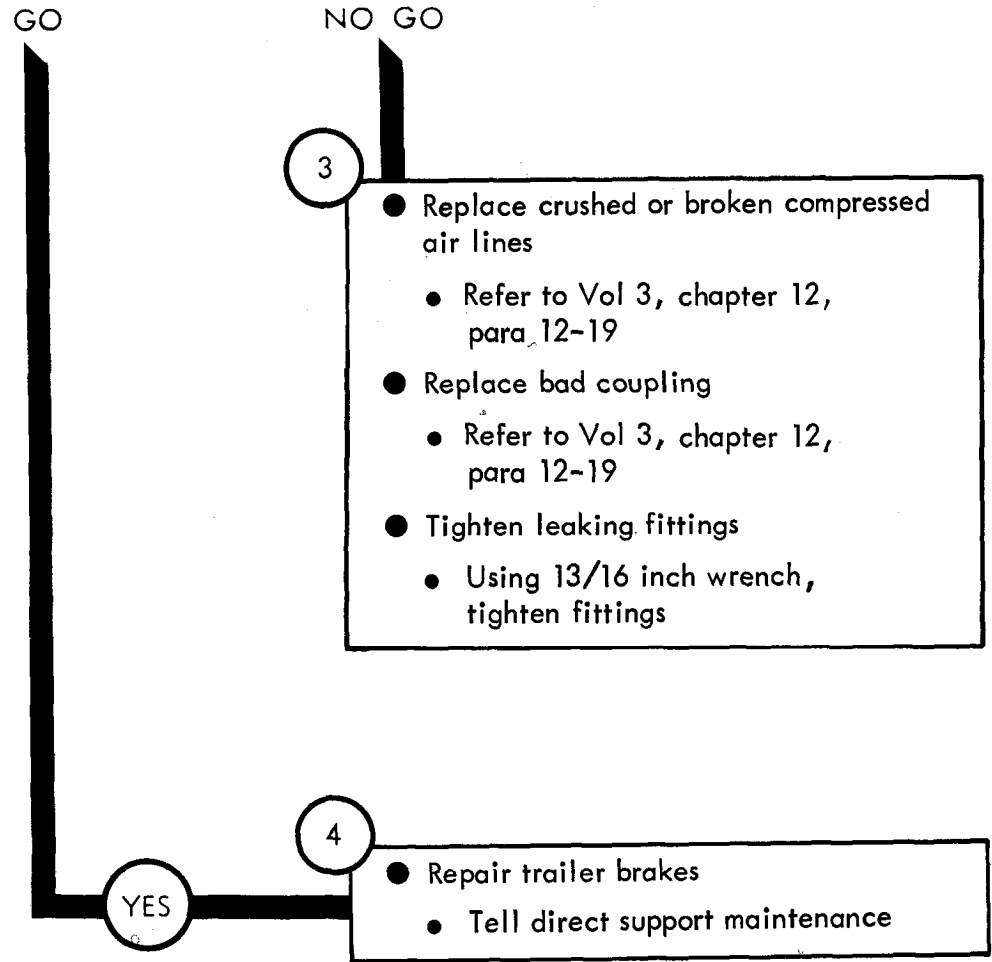

Figure 46-9 (Sheet 2 of 2)

Symptom

11

HANDBRAKE ASSEMBLY DRAGS AFTER HANDBRAKE LEVER IS PUT DOWN

1

- Make truck ready for work on handbrake
 - Park truck. Refer to TM 9-2320-211-10
 - Chock wheels

2

- Check brakeshoe retracting spring, and lever retracting spring at rear of transfer
 - Crawl under truck
 - Look for retracting springs that have come off mount
 - Look for worn or broken retracting spring

Are retracting springs OK?

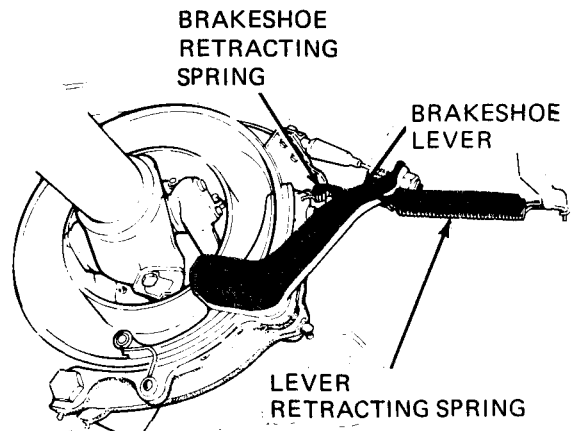

GO

TA 116201

Figure 46-11 (Sheet 1 of 3)

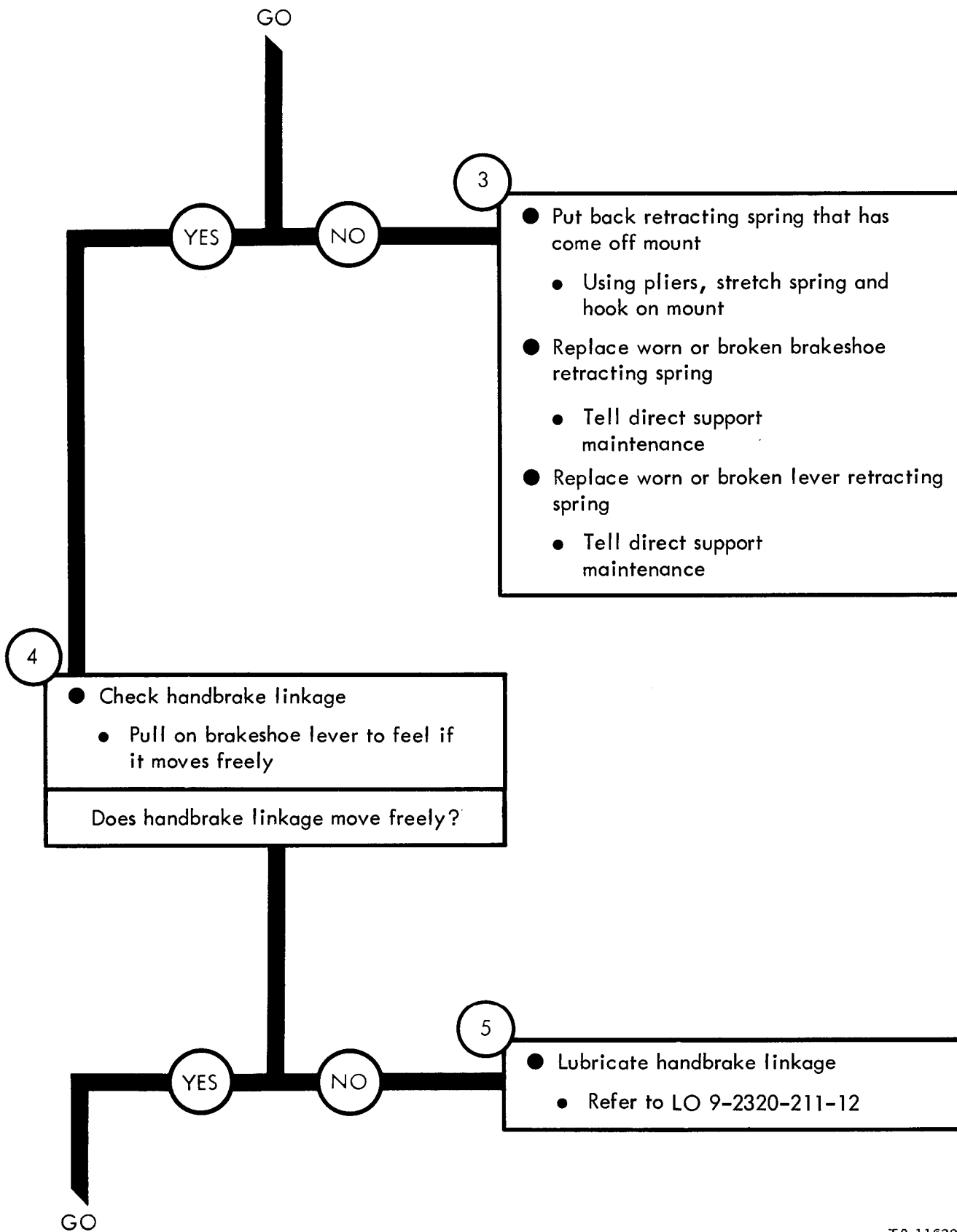

TA 116202

Figure 46-11 (Sheet 2 of 3)

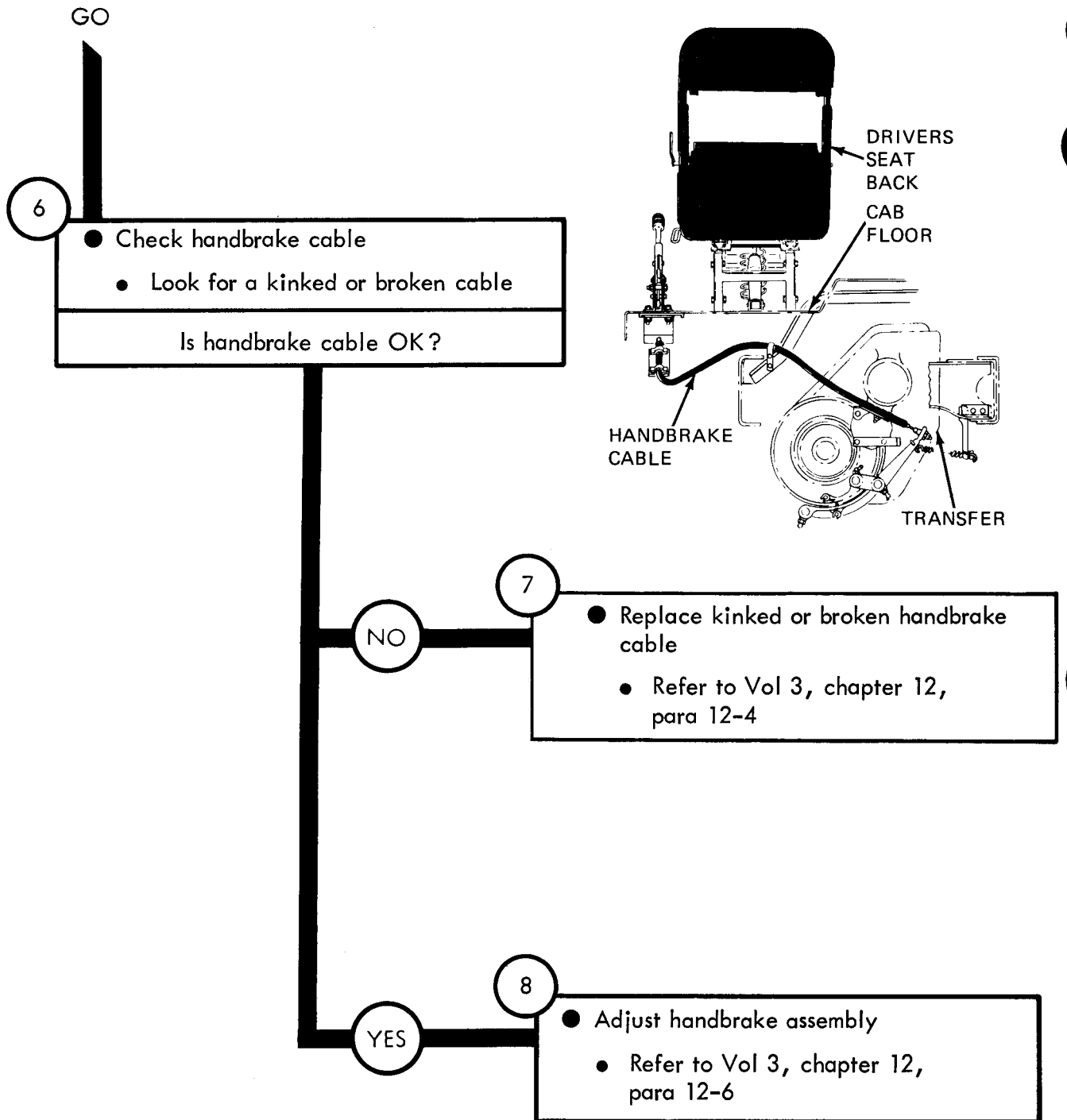

Figure 46-11 (Sheet 3 of 3)

CHAPTER 47

BRAKE SYSTEM TROUBLESHOOTING SUMMARY

47-1. GENERAL. This chapter gives a summary of troubleshooting procedures given in chapter 46, for the Brake System.

47-2. PROCEDURES. The summary in this chapter covers all fault symptoms found in the detailed troubleshooting procedures in Part 1. Chapter 7 outlines a sample troubleshooting procedure. The summary procedures are based on the "what-to-do" portions of the detailed procedures and do not include the "How-to-do-it" instructions. Warnings, cautions, and notes are given where needed.

BRAKE SYSTEM TROUBLESHOOTING SUMMARY

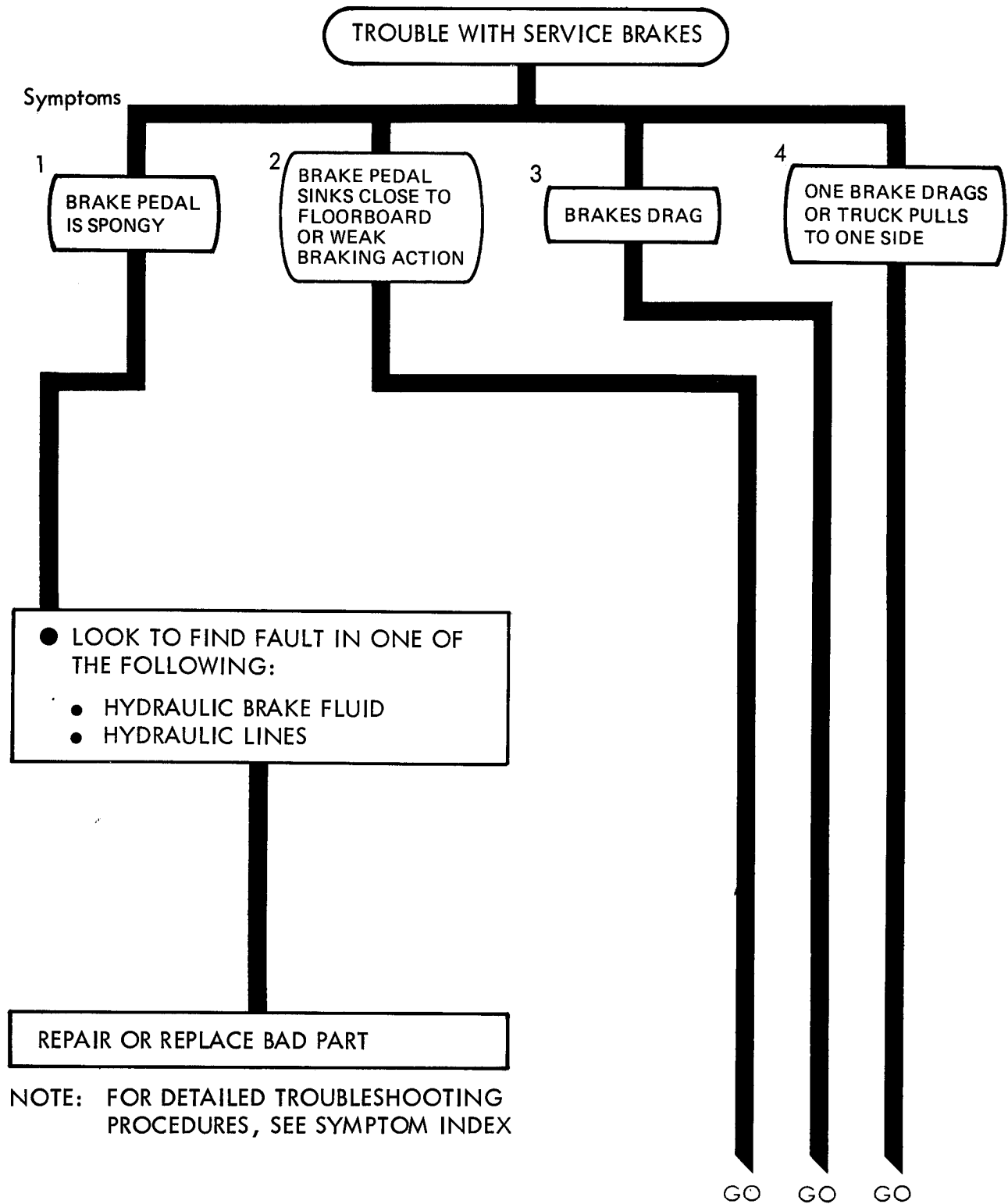

Figure 47-1 (Sheet 1 of 9)

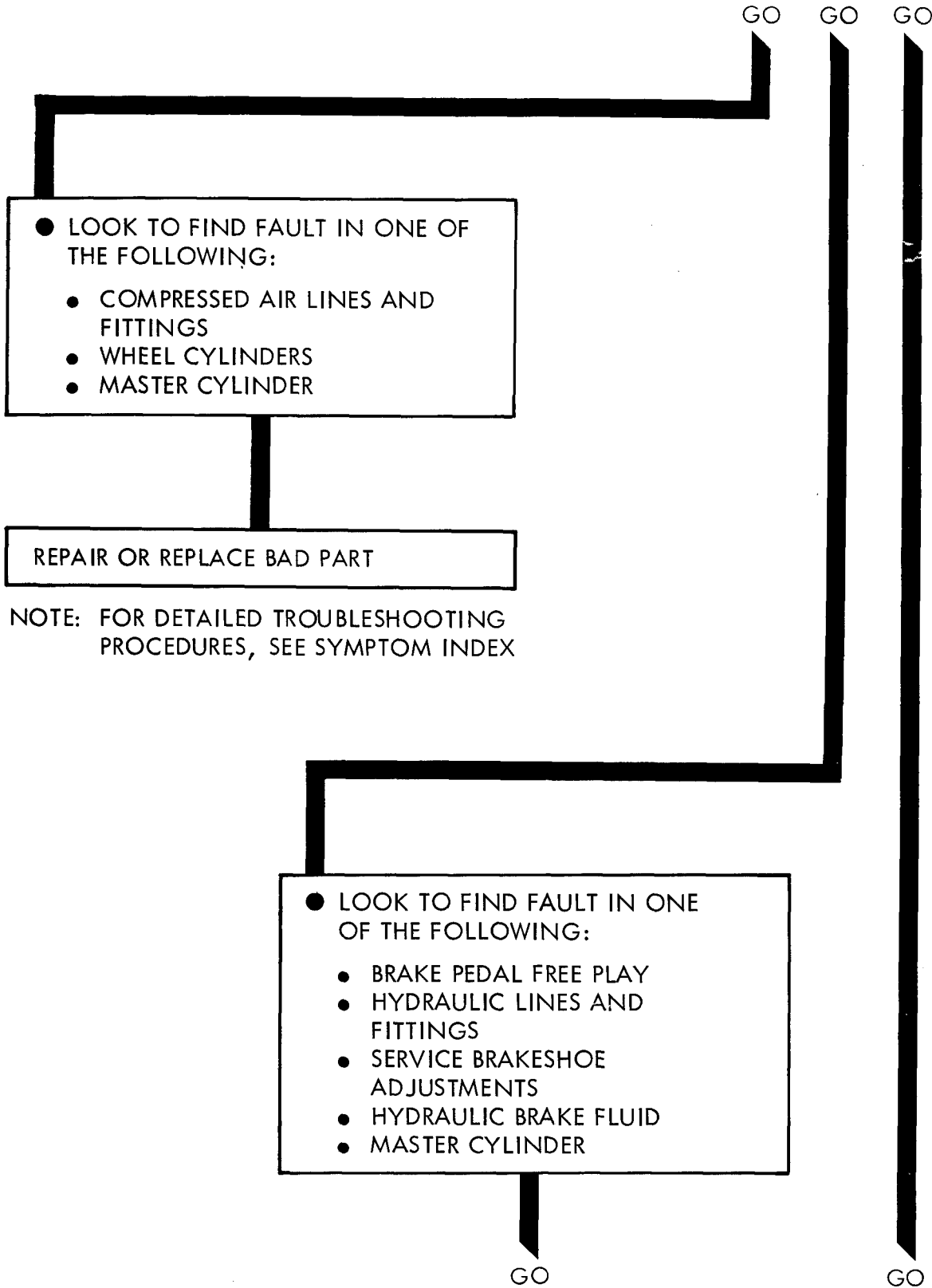

Figure 47-1 (Sheet 2 of 9)

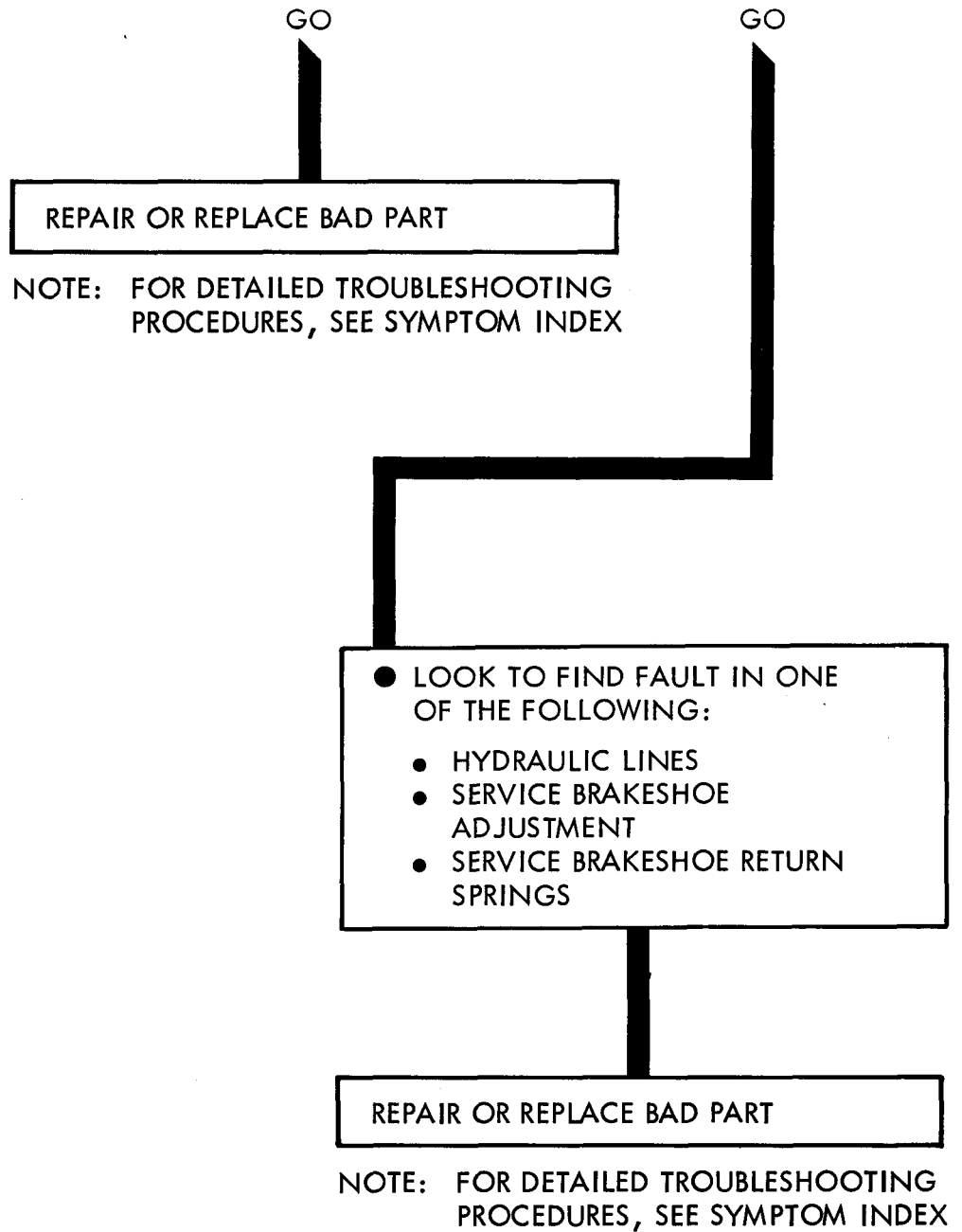
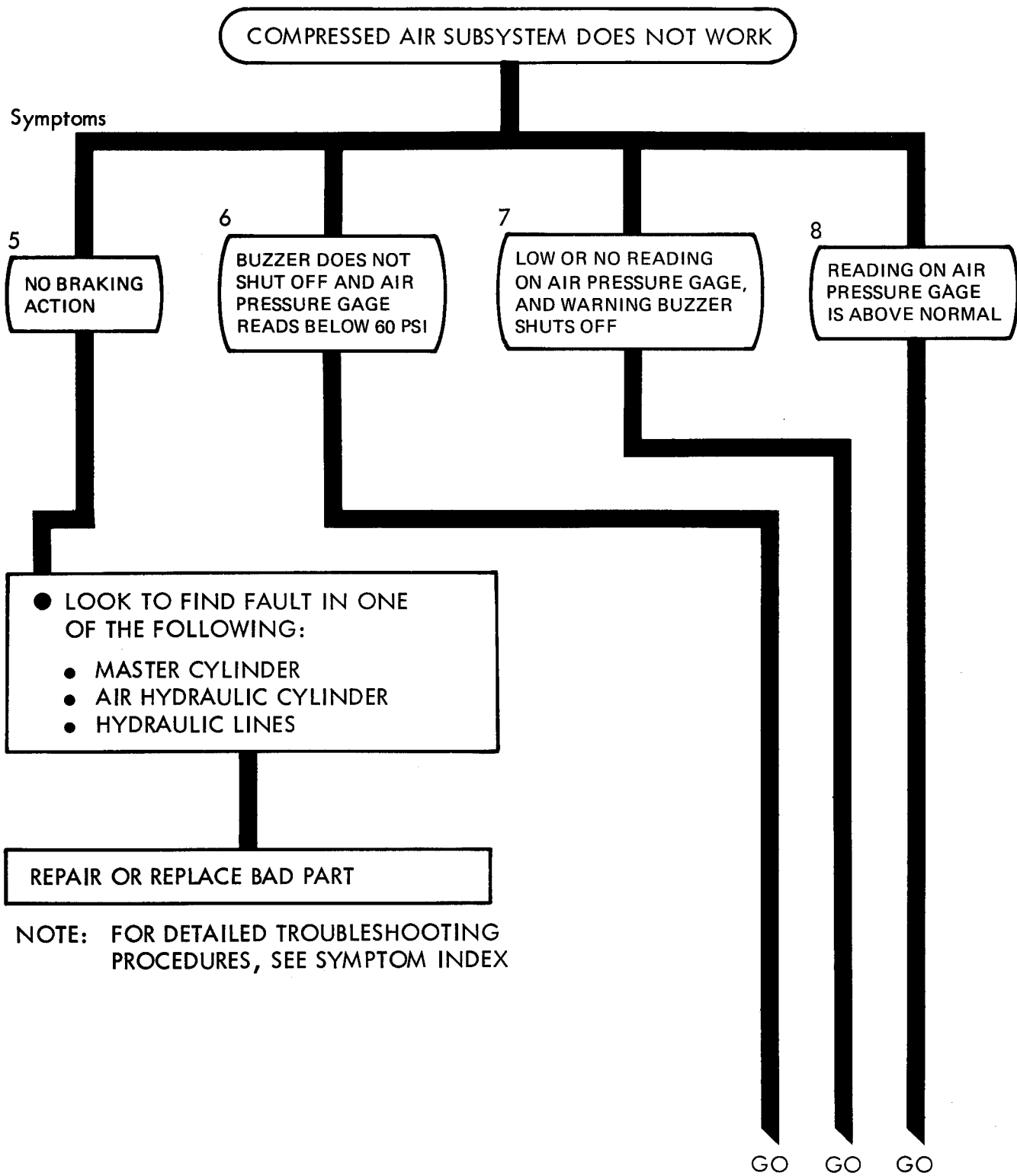

Figure 47-1 (Sheet 3 of 9)



TA 116207

Figure 47-1 (Sheet 4 of 9)

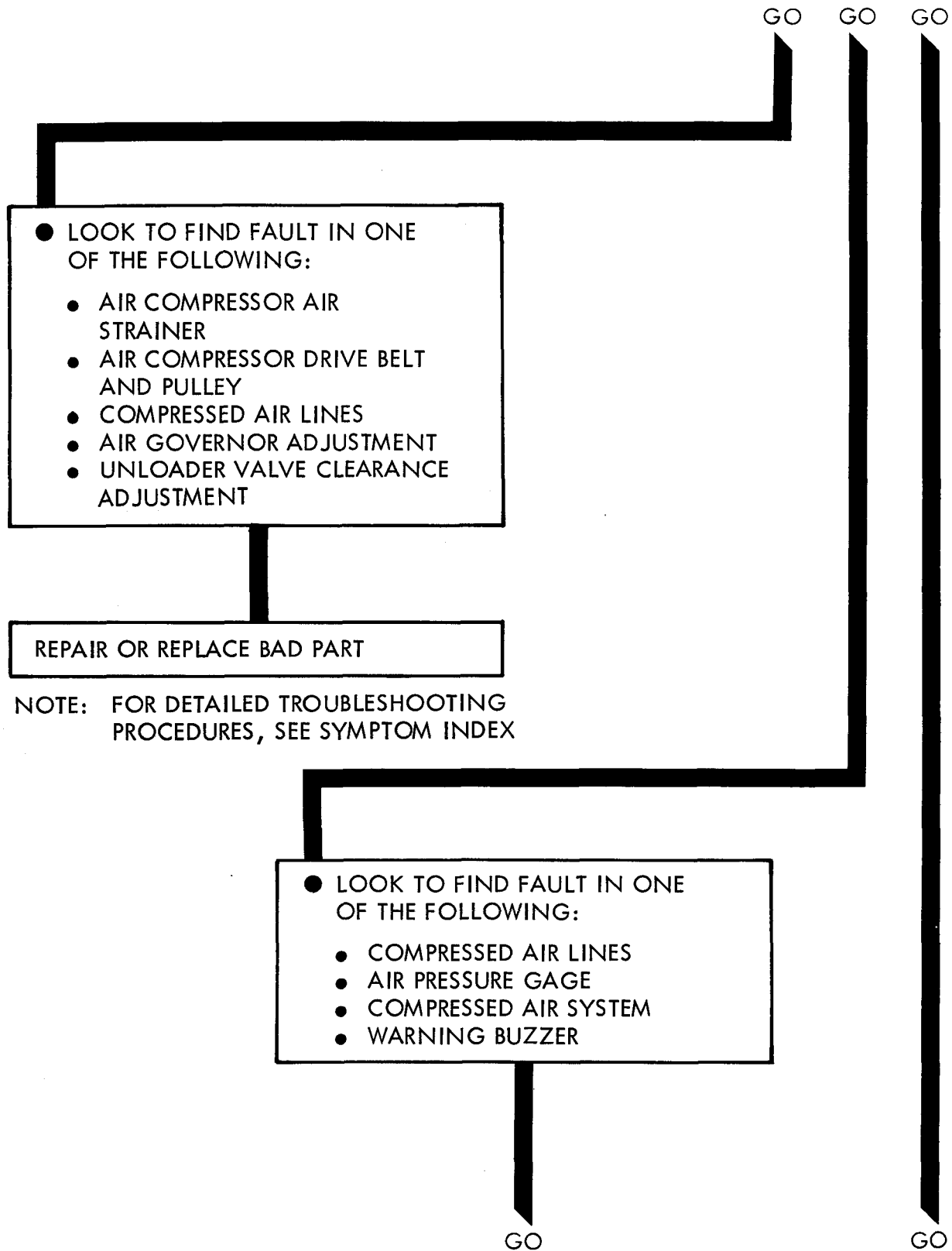

Figure 47-1 (Sheet 5 of 9)

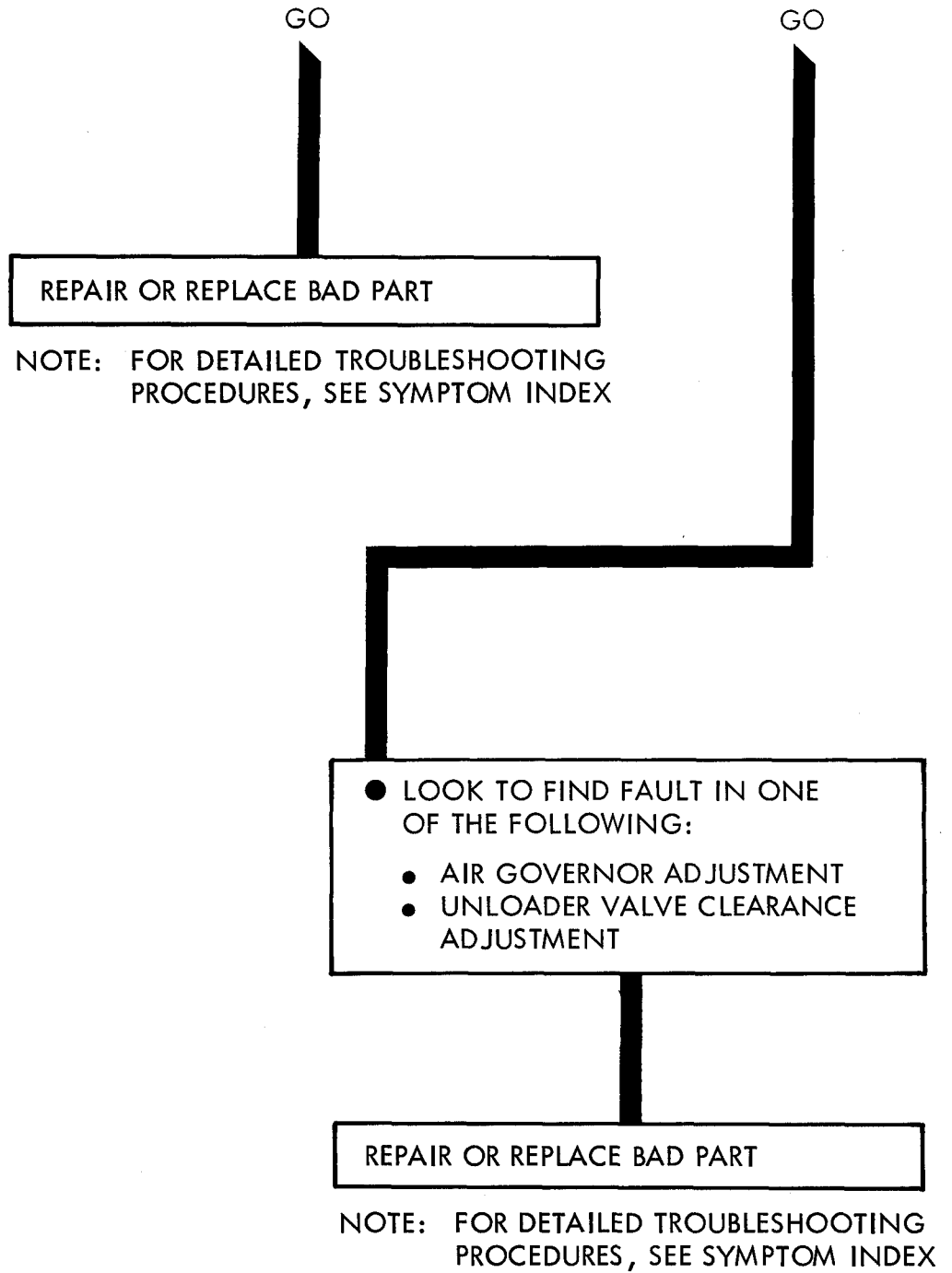
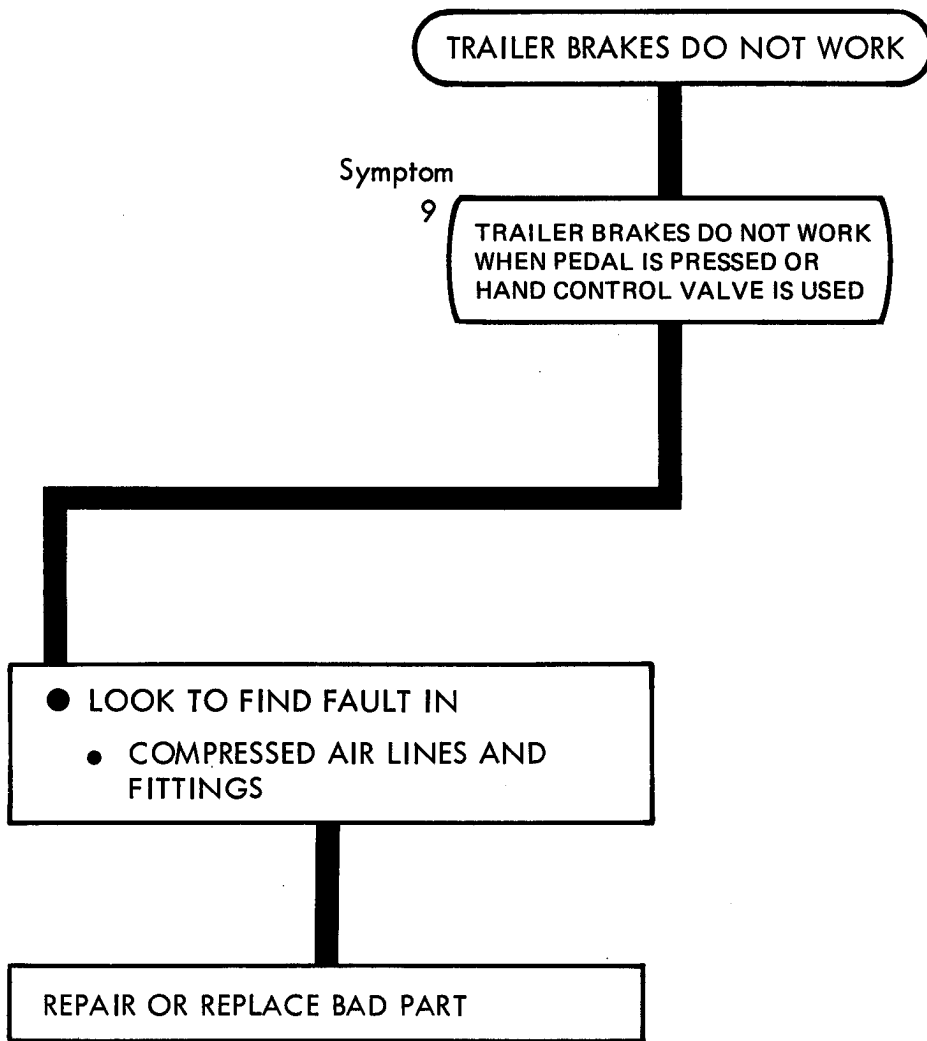
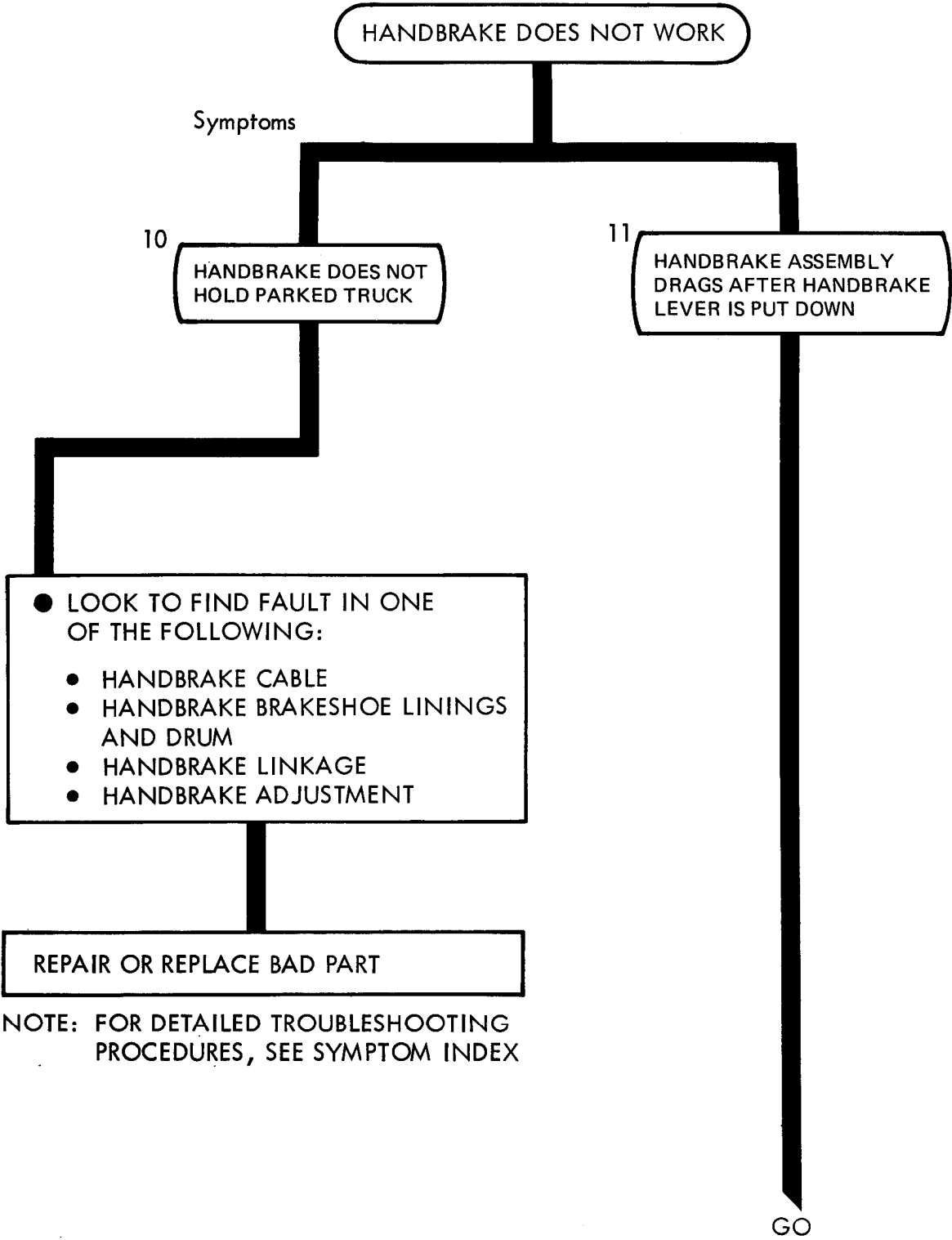

Figure 47-1 (Sheet 6 of 9)



NOTE: FOR DETAILED TROUBLESHOOTING PROCEDURES, SEE SYMPTOM INDEX

Figure 47-1 (Sheet 7 of 9)



NOTE: FOR DETAILED TROUBLESHOOTING PROCEDURES, SEE SYMPTOM INDEX

Figure 47-1 (Sheet 8 of 9)

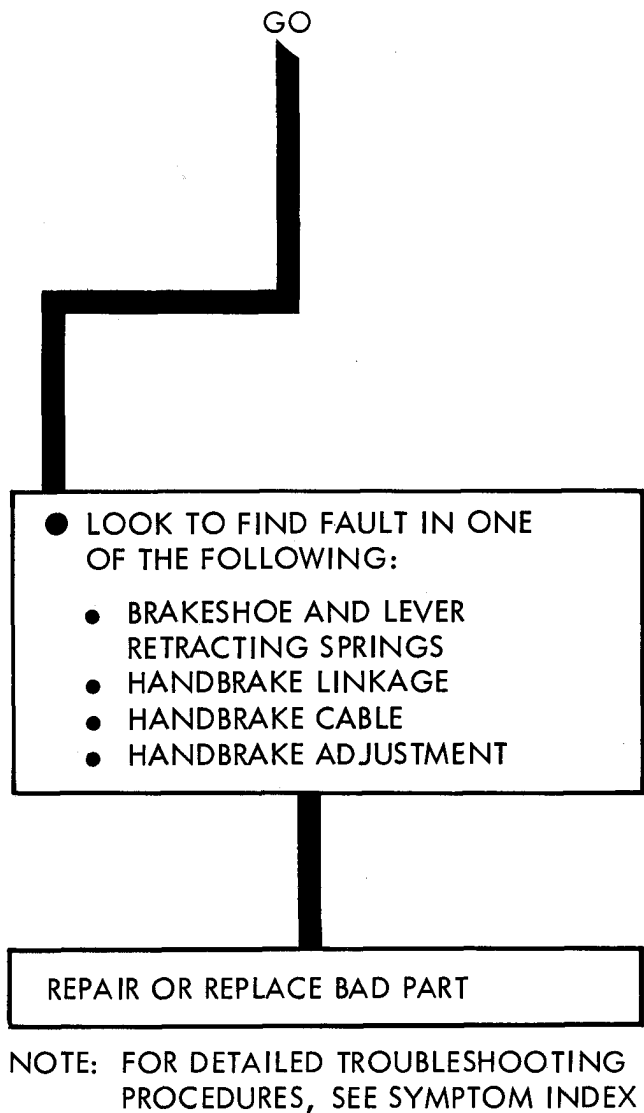
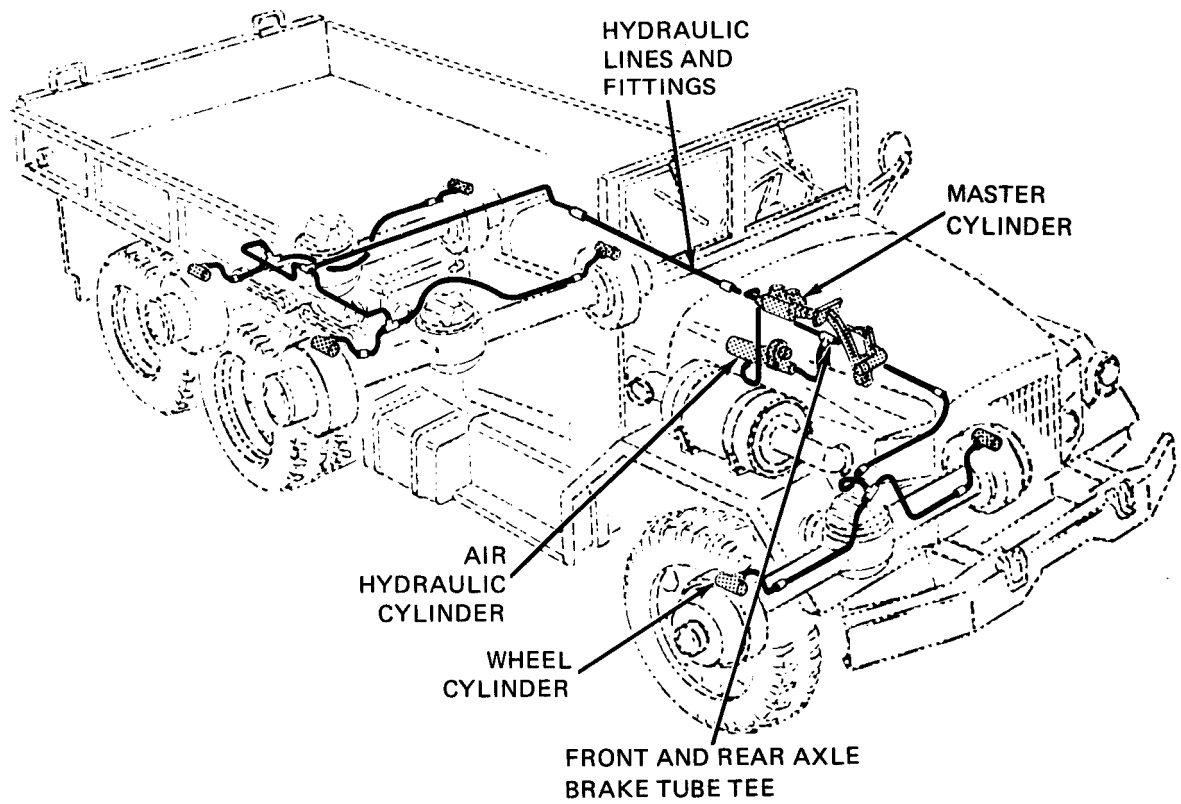

Figure 47-1 (Sheet 9 of 9)

CHAPTER 48

BRAKE SYSTEM SUPPORT DIAGRAMS

48-1. GENERAL. This chapter gives the diagrams you need when doing troubleshooting procedures in chapter 46. Table 3-1 is a complete listing of all support diagrams used in this manual.



TA 116213

Figure 48-1. Brake Hydraulic Lines

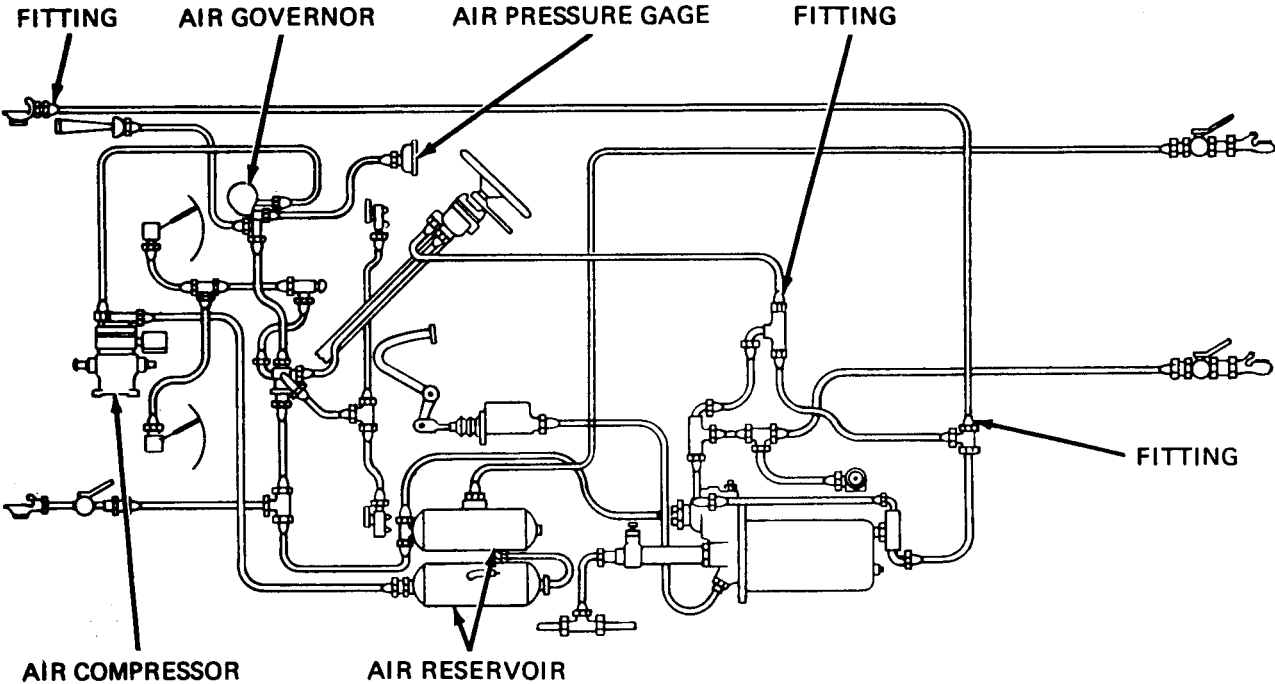

TA 116214

Figure 48-2. Compressed Air System

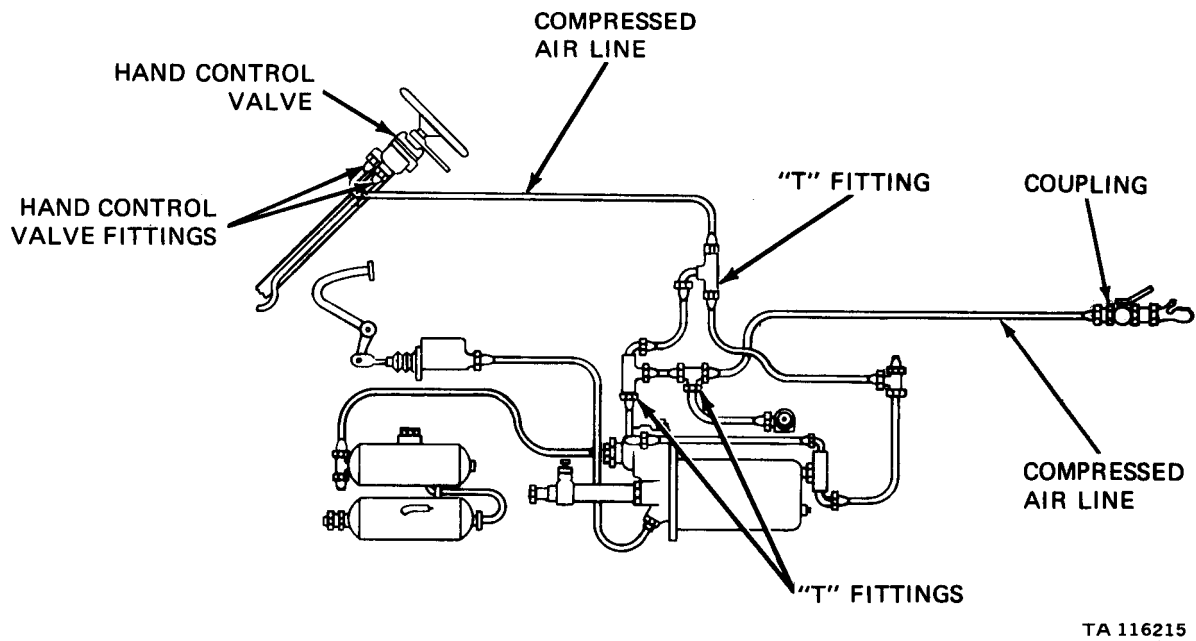

Figure 48-3. Compressor Air System (Trailer Brakes)

CHAPTER 49

BRAKE SYSTEM TEST PROCEDURES

49-1. GENERAL. This chapter gives test procedures for the tests given in chapter 46, for the Brake System.

49-2. TEST SET-UP. Instructions for setup of test equipment and parts to be tested are given before the test procedures. Illustrations are used, when needed, to show you how to hook up the test equipment to the part to be tested.

49-3. TEST PROCEDURE. Detailed step-by-step instructions, in flow chart form, are given for each test. The procedure calls out the type of test and the condition of the truck system for each part of testing. The step-by-step test will lead you to the bad component or to a fault symptom within a related system. Reference is made to the fault symptom index, chapter 6, if the test shows a fault in another system.

MASTER CYLINDER LEAKAGE TEST

- Check for leakage in master cylinder

NOTE: Two soldiers will be needed to do this test. Soldier A will check the master cylinder and soldier B will sit in the cab and work the brake pedal

- SOLDIER A:
- Using a 1/2-inch wrench, unscrew and take off hydraulic line from master cylinder
 - screw in a 1/2-inch pipe plug and tighten using pipe plug wrench

- SOLDIER B:
- Press down hard on brake pedal and feel if brake pedal slowly sinks to floorboard. If brake pedal does not sink close to floorboard, master cylinder is good

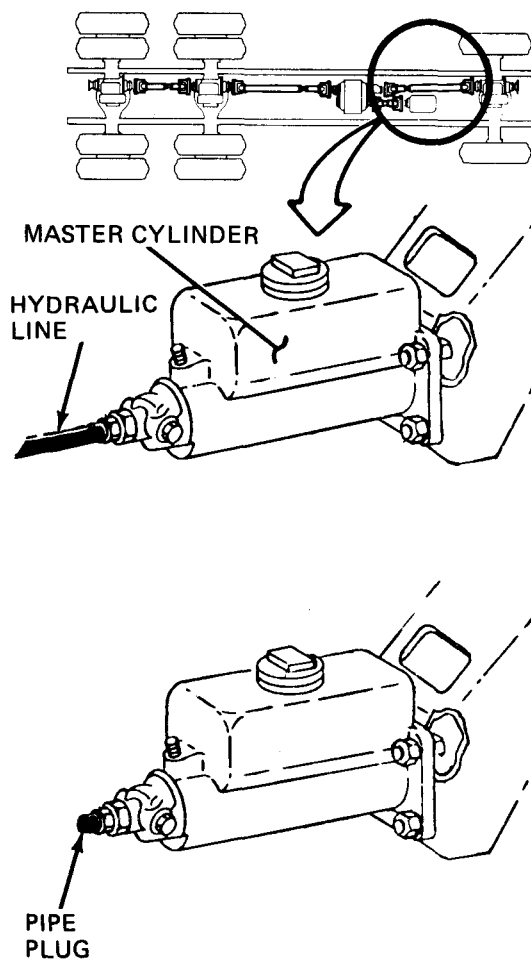

Figure 49-1

CHAPTER 50

BRAKE SYSTEM CHECKOUT PROCEDURES

50-1. GENERAL. This chapter gives procedures for checking out the system after troubleshooting and repair have been done. Procedures are set up in flow chart form showing the checkout steps in order and referring to the fault symptom index when the system does not check out.

BRAKE SYSTEM CHECKOUT

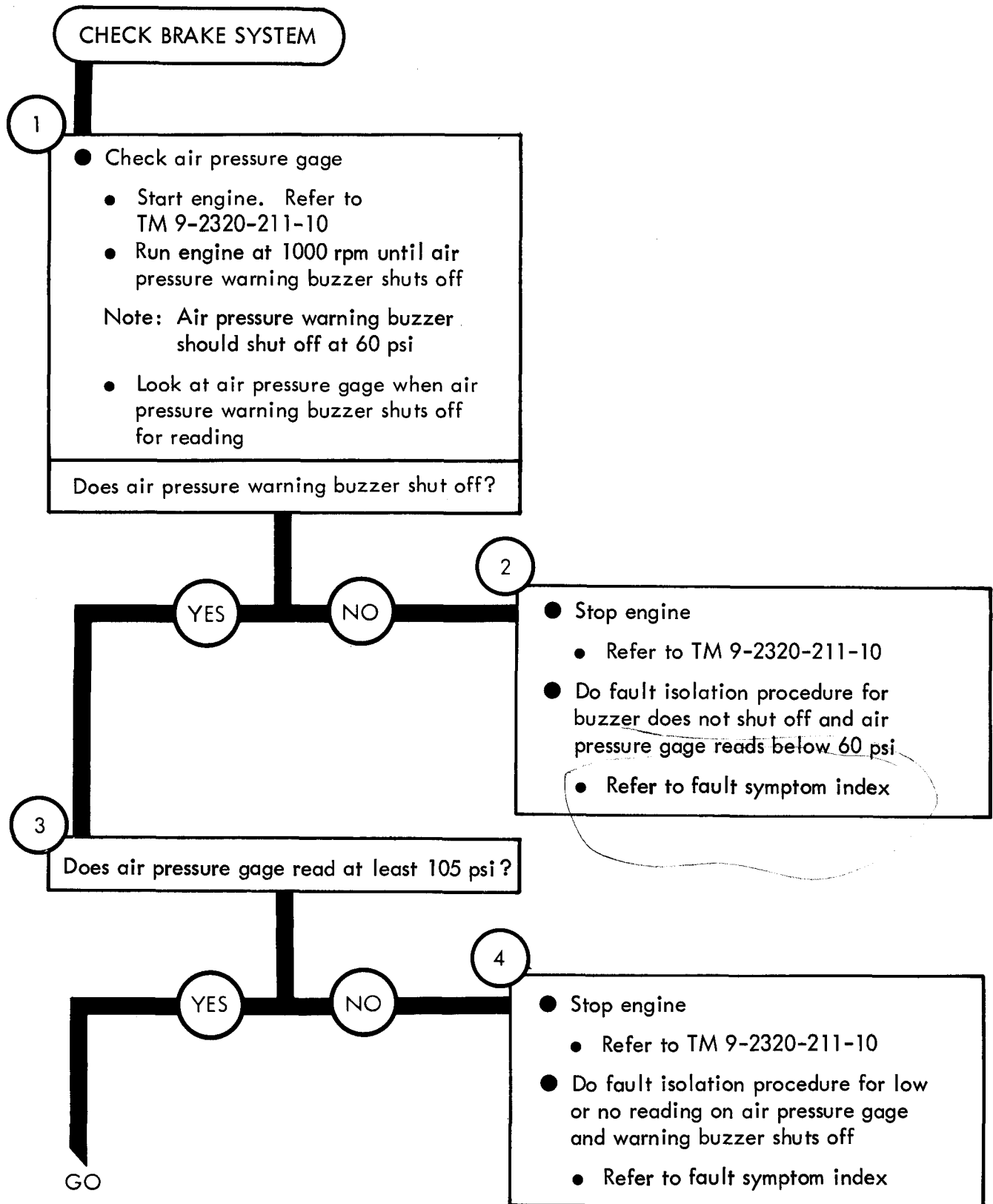

Figure 50-1 (Sheet 1 of 9)

TA 116217

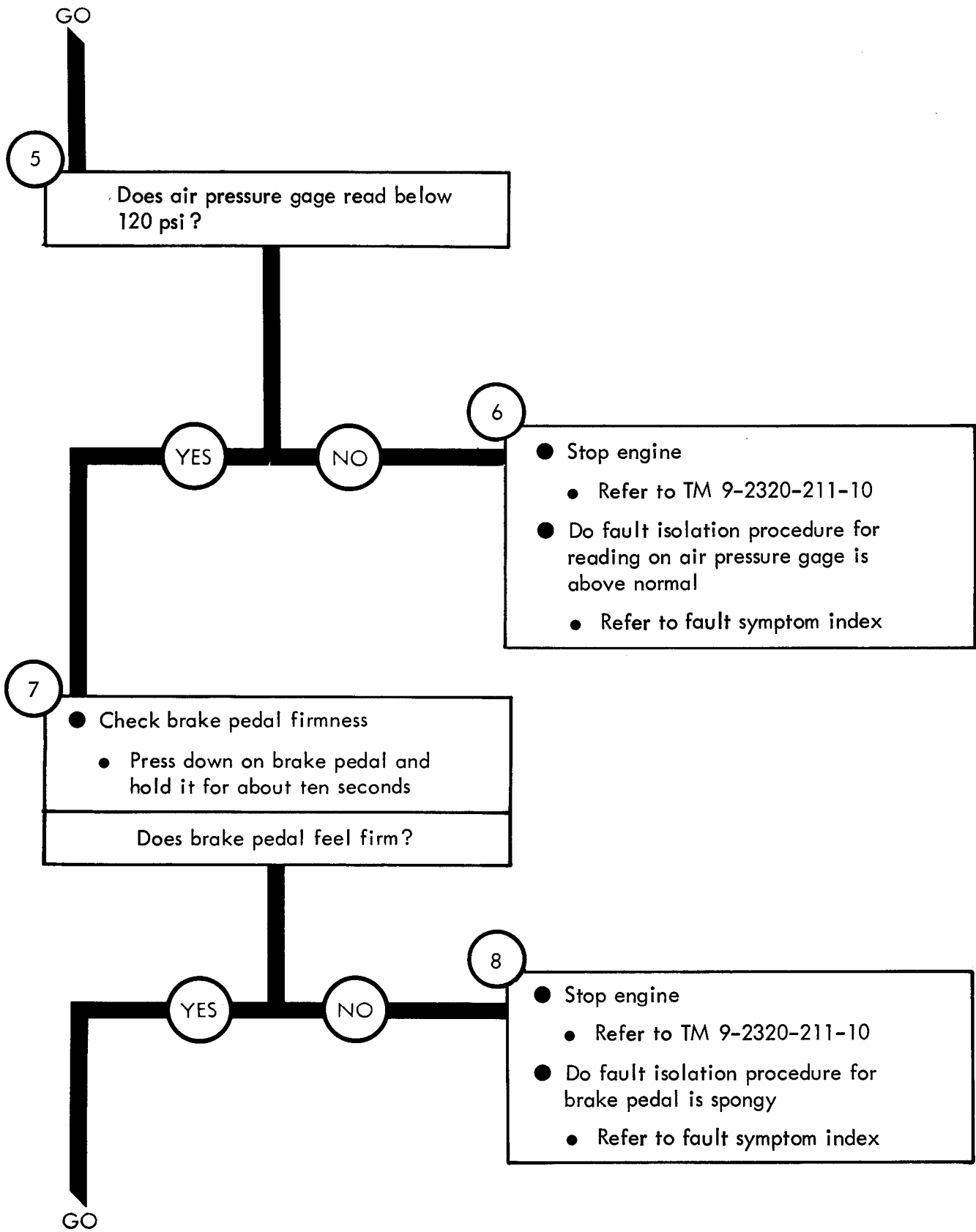

Figure 50-1 (Sheet 2 of 9)

TA 116218

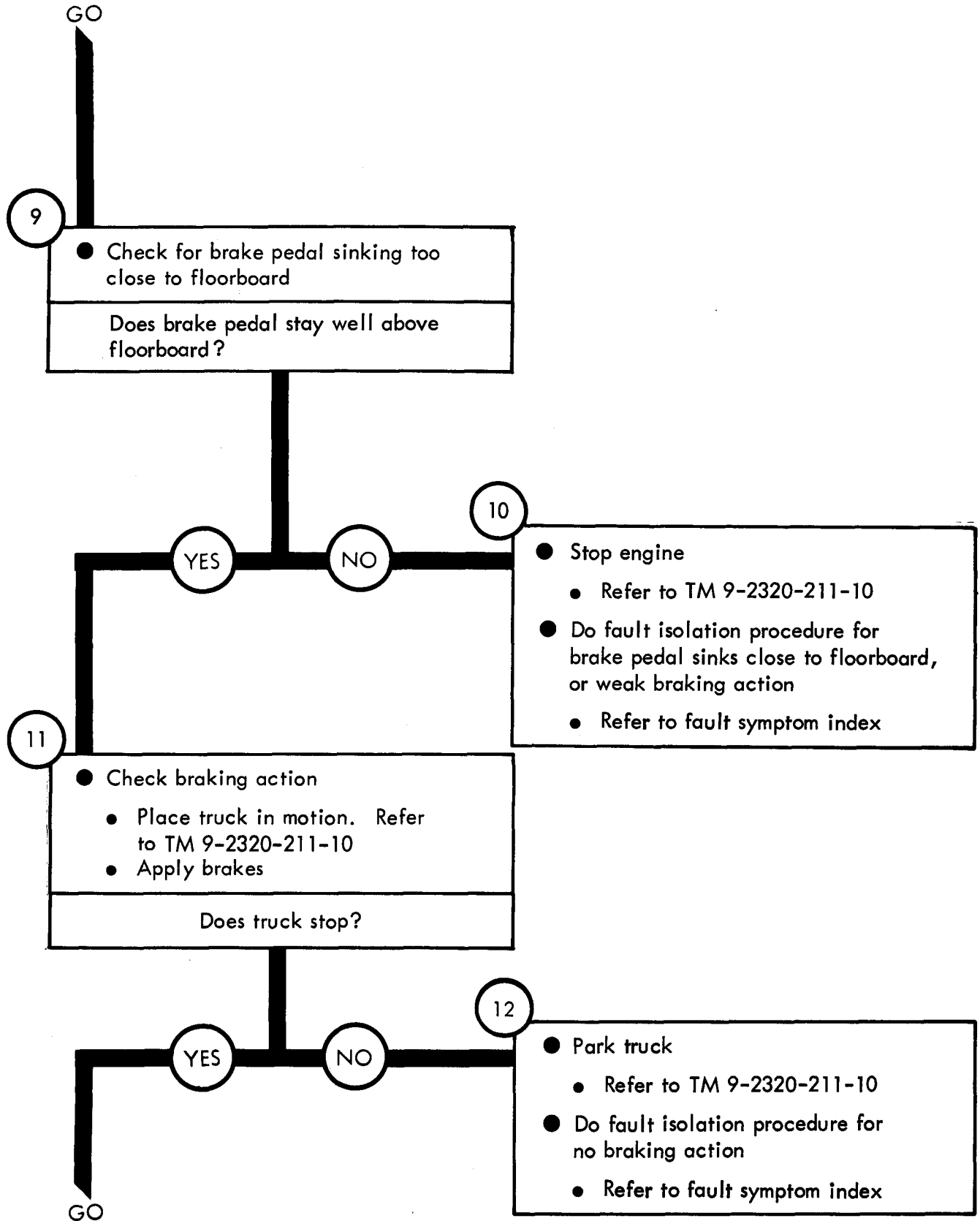

Figure 50-1 (Sheet 3 of 9)

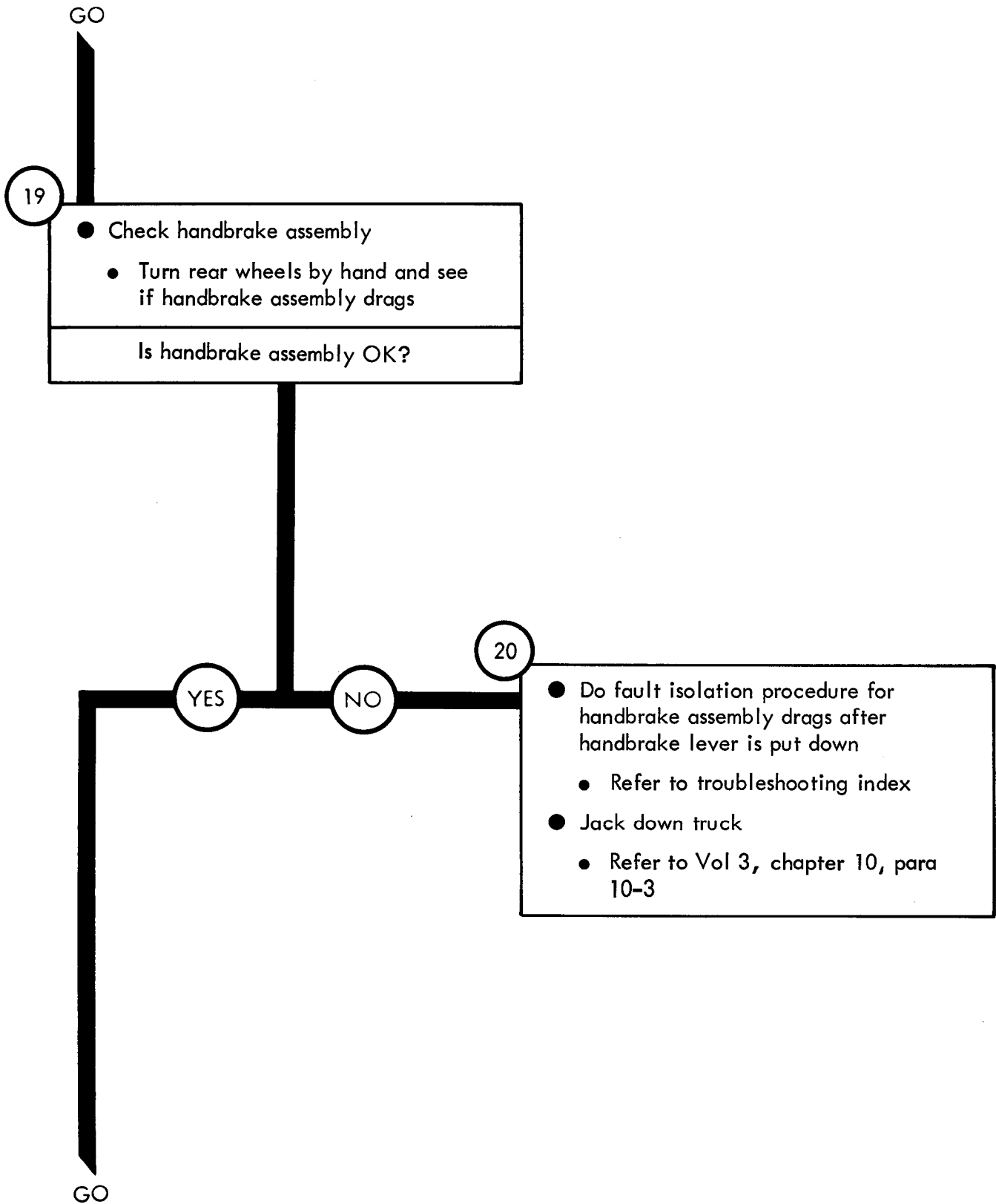

Figure 50-1 (Sheet 6 of 9)

TA 116221

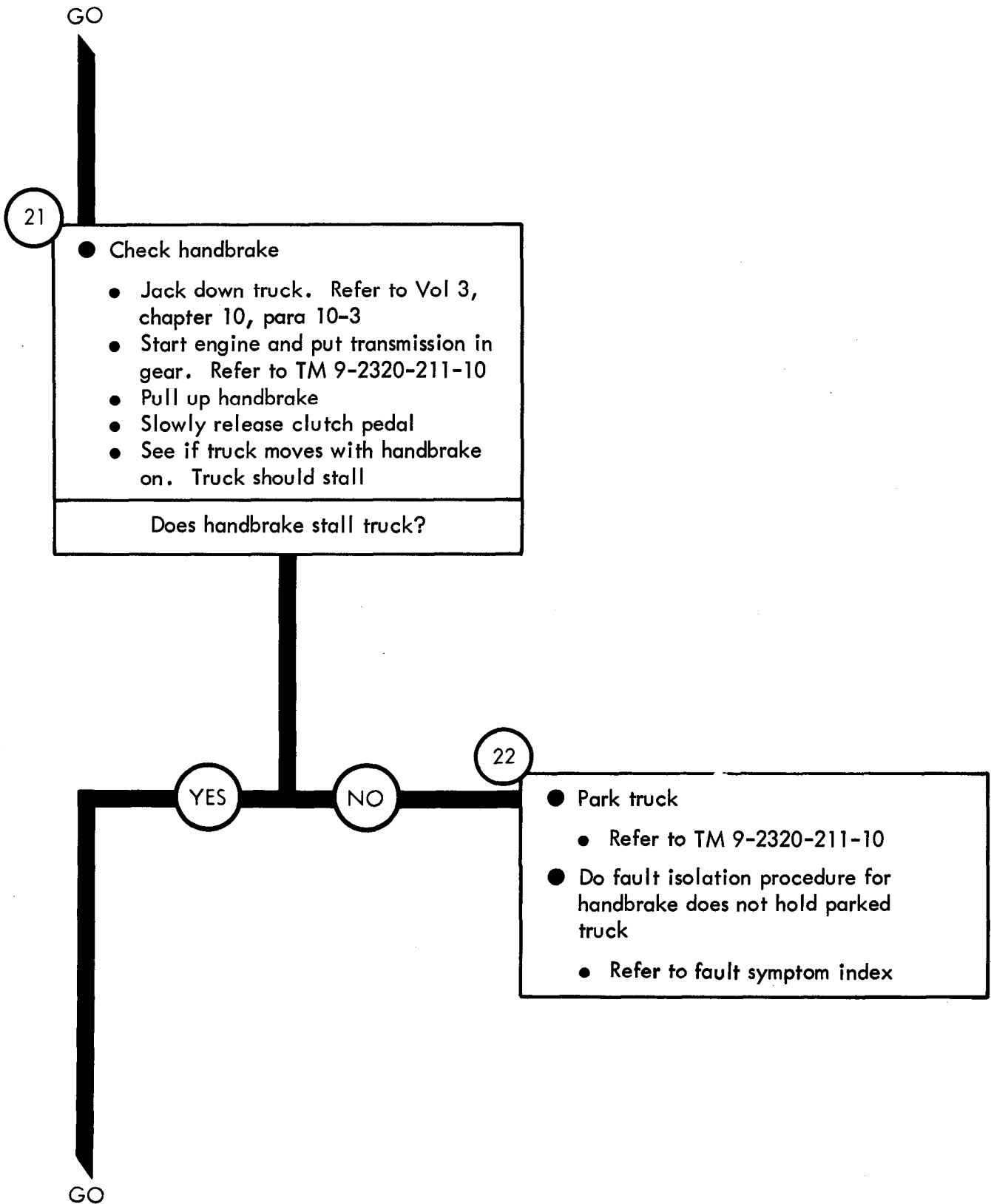

Figure 50-1 (Sheet 7 of 9)

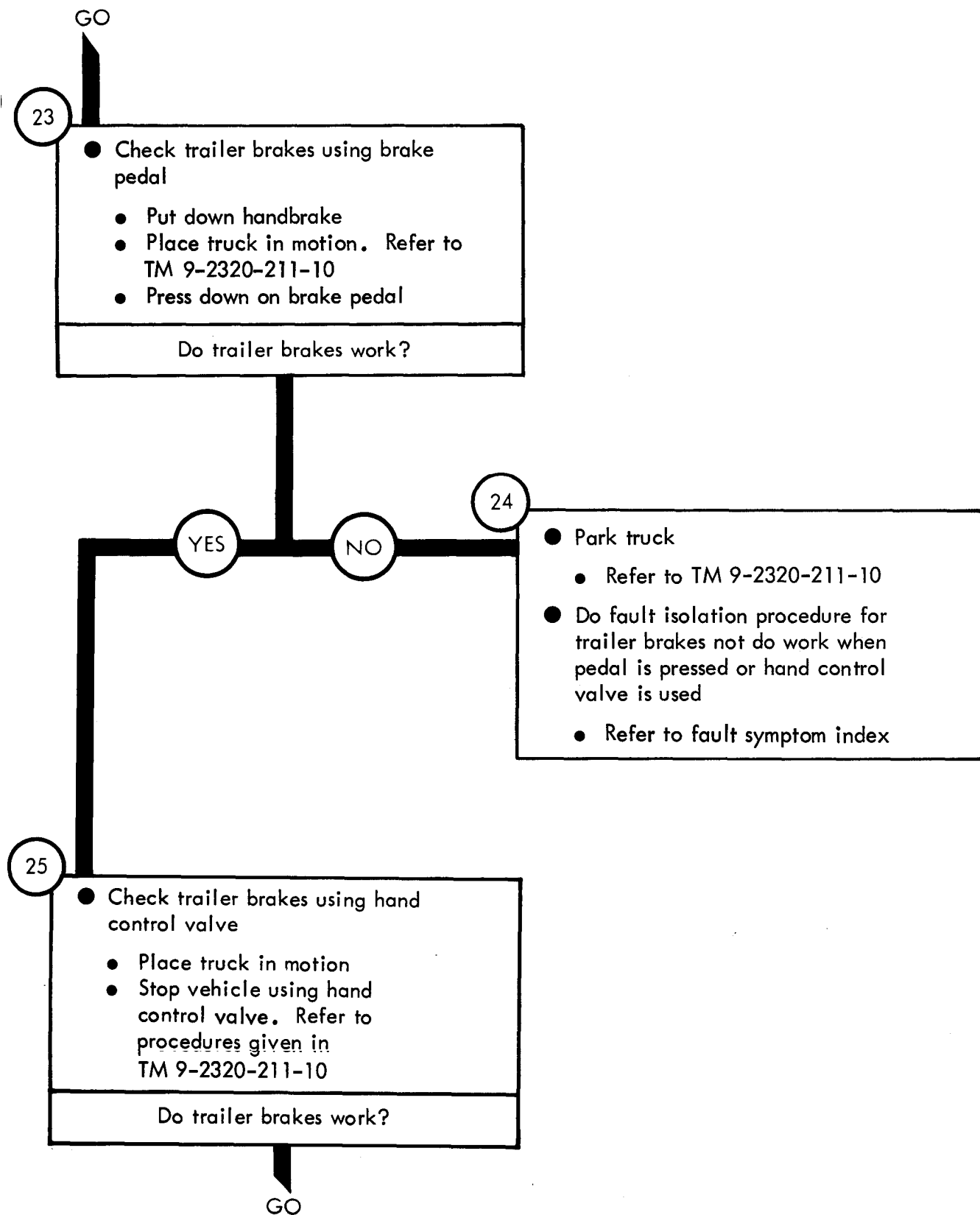

Figure 50-1 (Sheet 8 of 9)

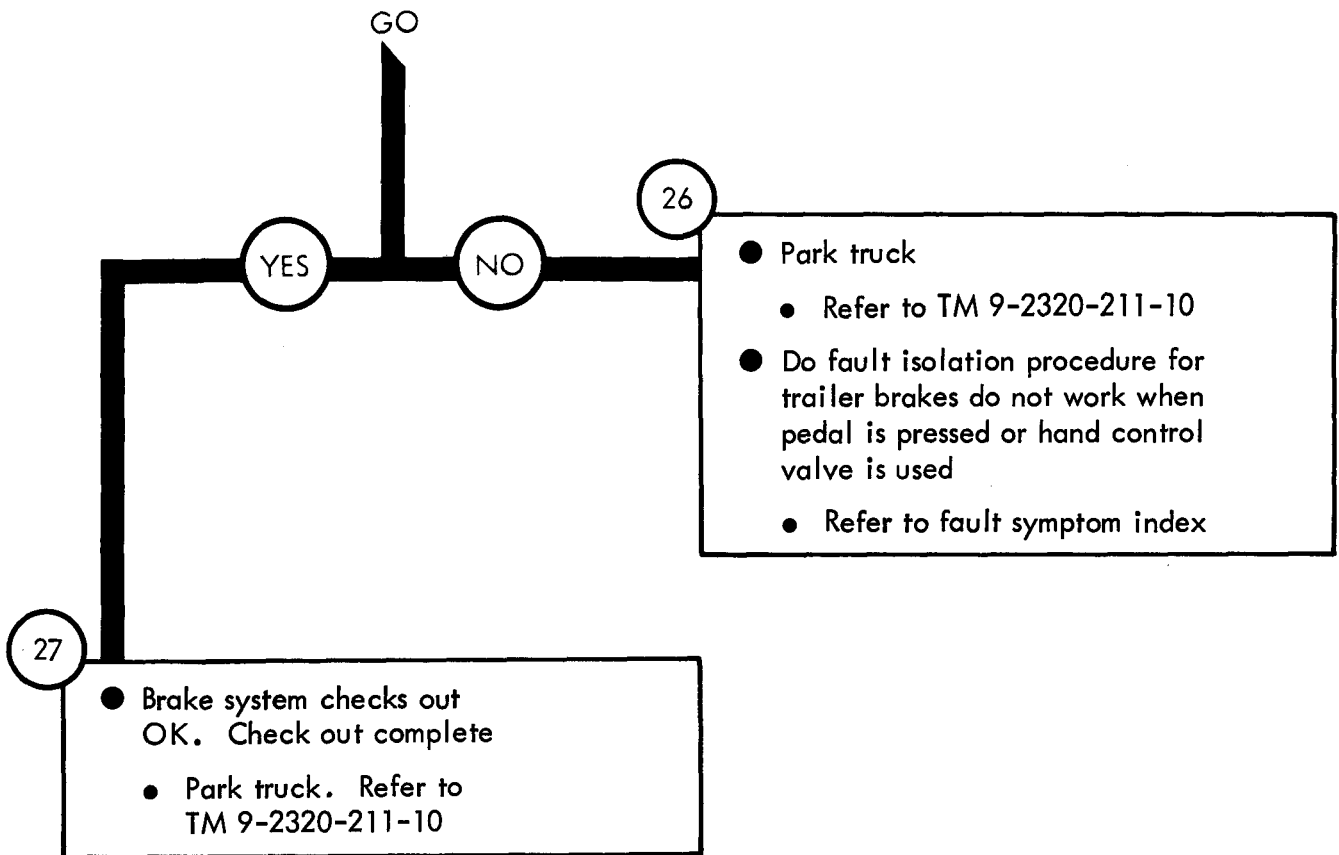

Figure 50-1 (Sheet 9 of 9)

CHAPTER 51

WHEEL SYSTEM TROUBLESHOOTING

51-1. EQUIPMENT ITEMS COVERED. This chapter gives equipment troubleshooting procedures for the wheel system, for which there are authorized corrective maintenance tasks at the organizational maintenance level.

51-2. EQUIPMENT ITEMS NOT COVERED. All equipment items for which corrective maintenance is authorized at the organizational maintenance level are covered in this chapter.

WHEEL SYSTEM TROUBLESHOOTING

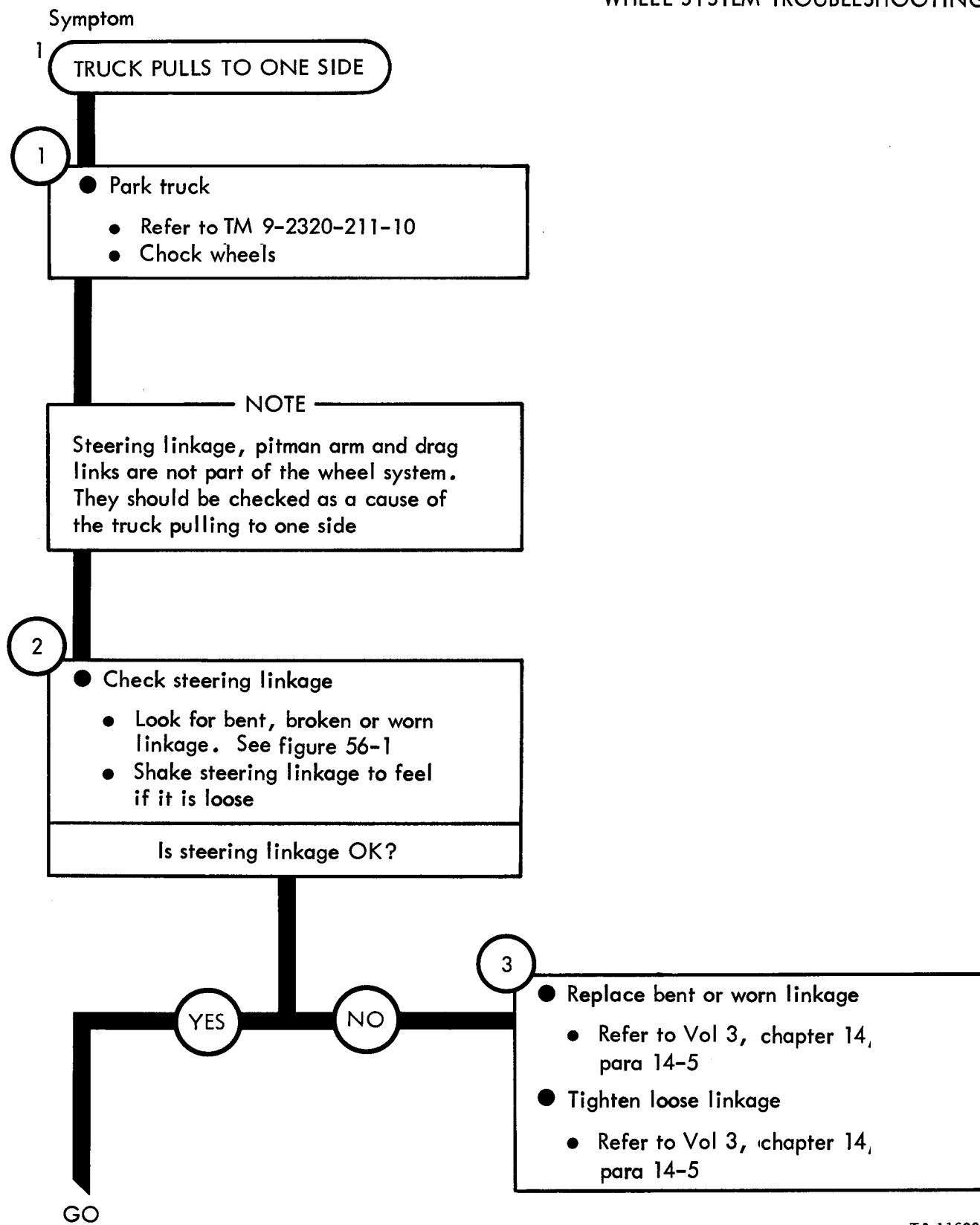

Figure 51-1 (Sheet 1 of 4)

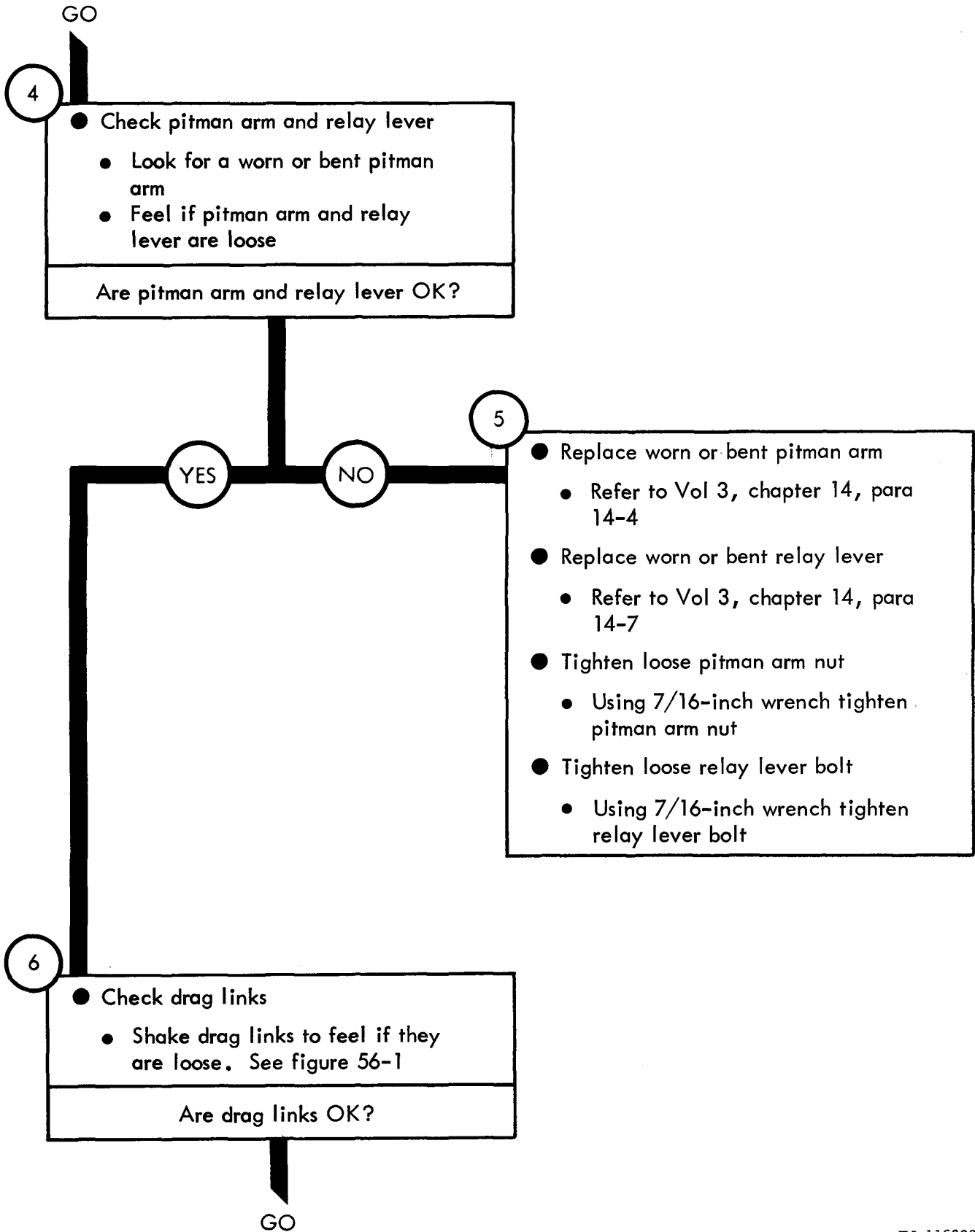

Figure 51-1 (Sheet 2 of 4)

TA 116228

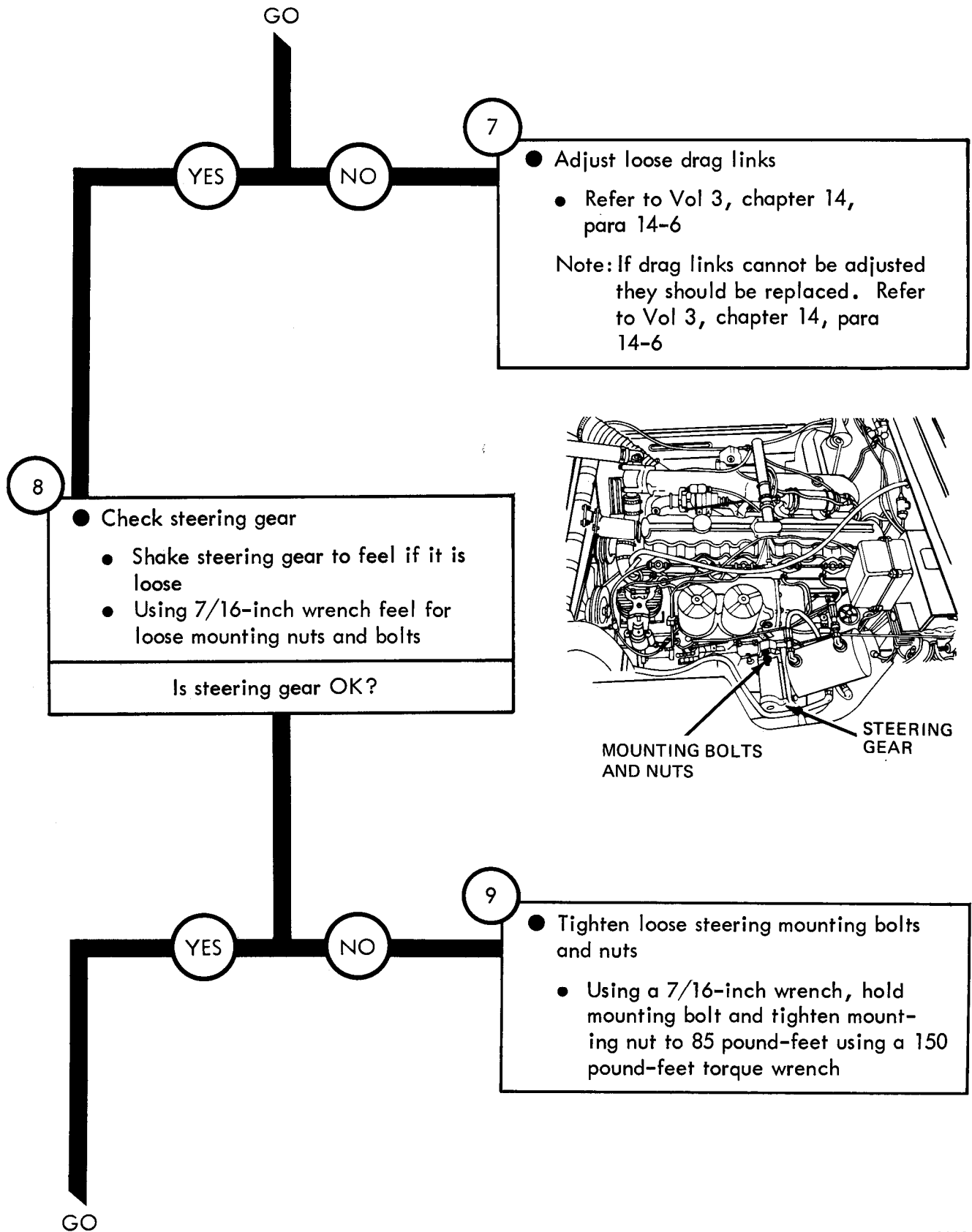

Figure 51-1 (Sheet 3 of 4)

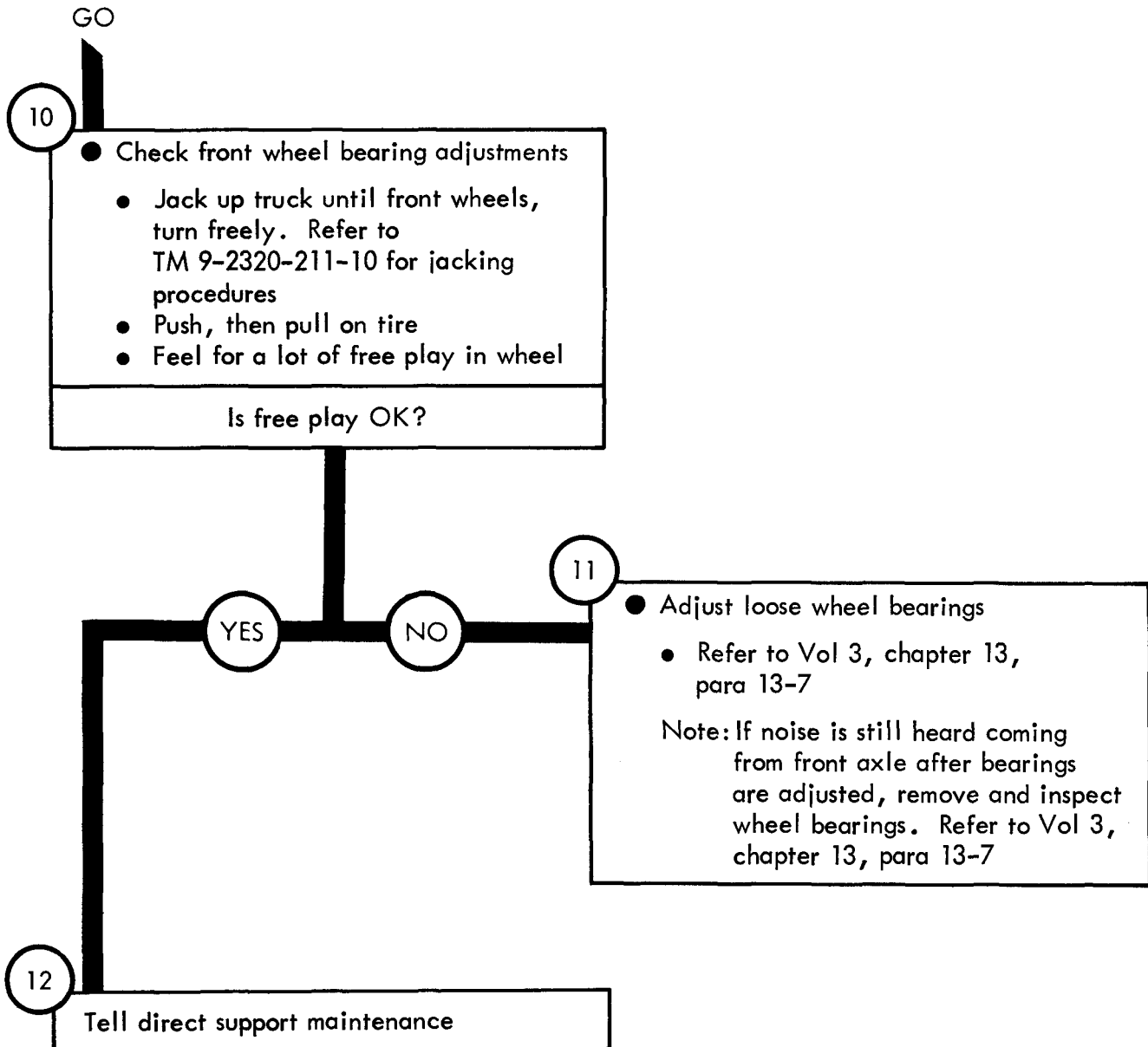
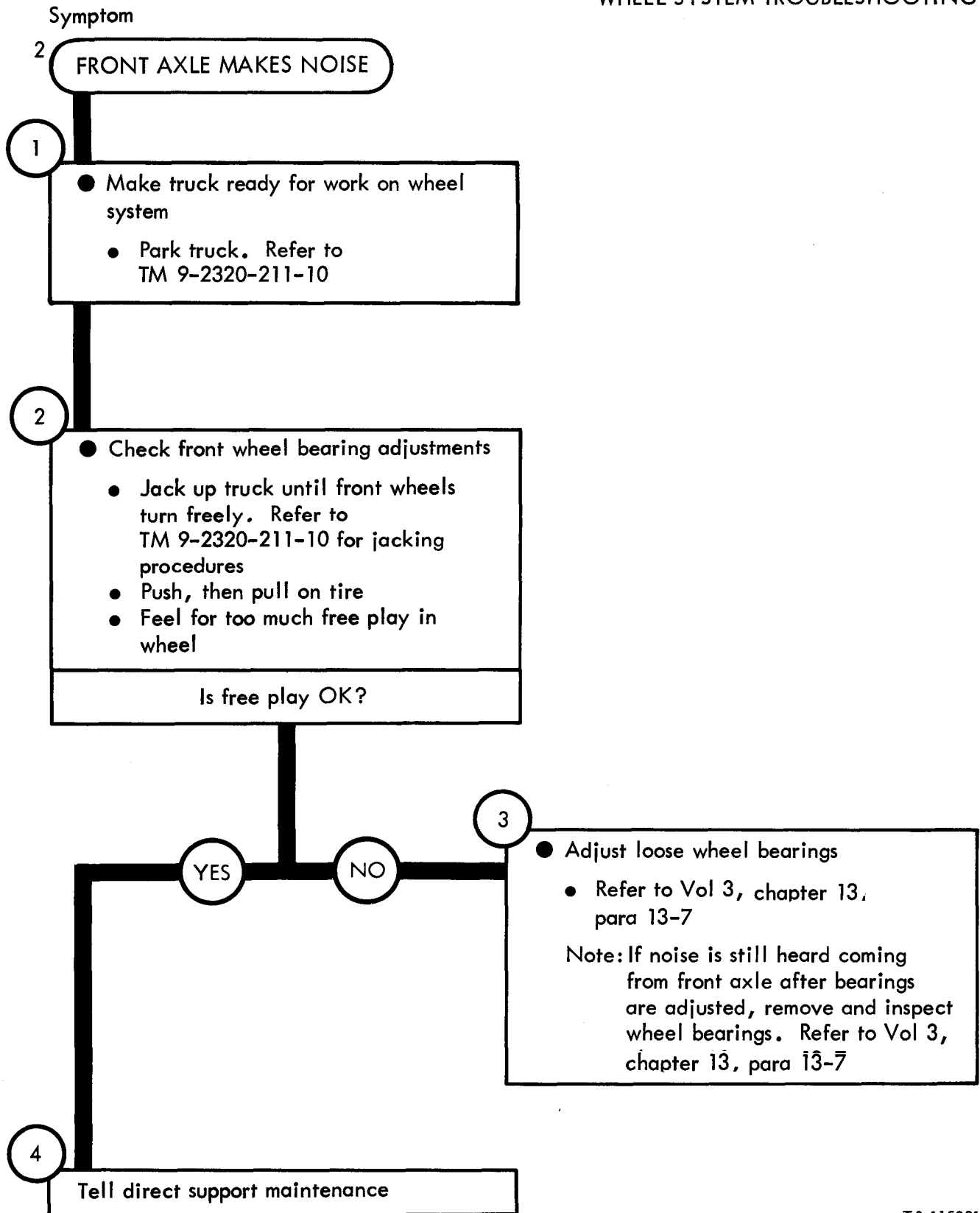

Figure 51-1 (Sheet 4 of 4)

WHEEL SYSTEM TROUBLESHOOTING



TA 116231

figure 51-2

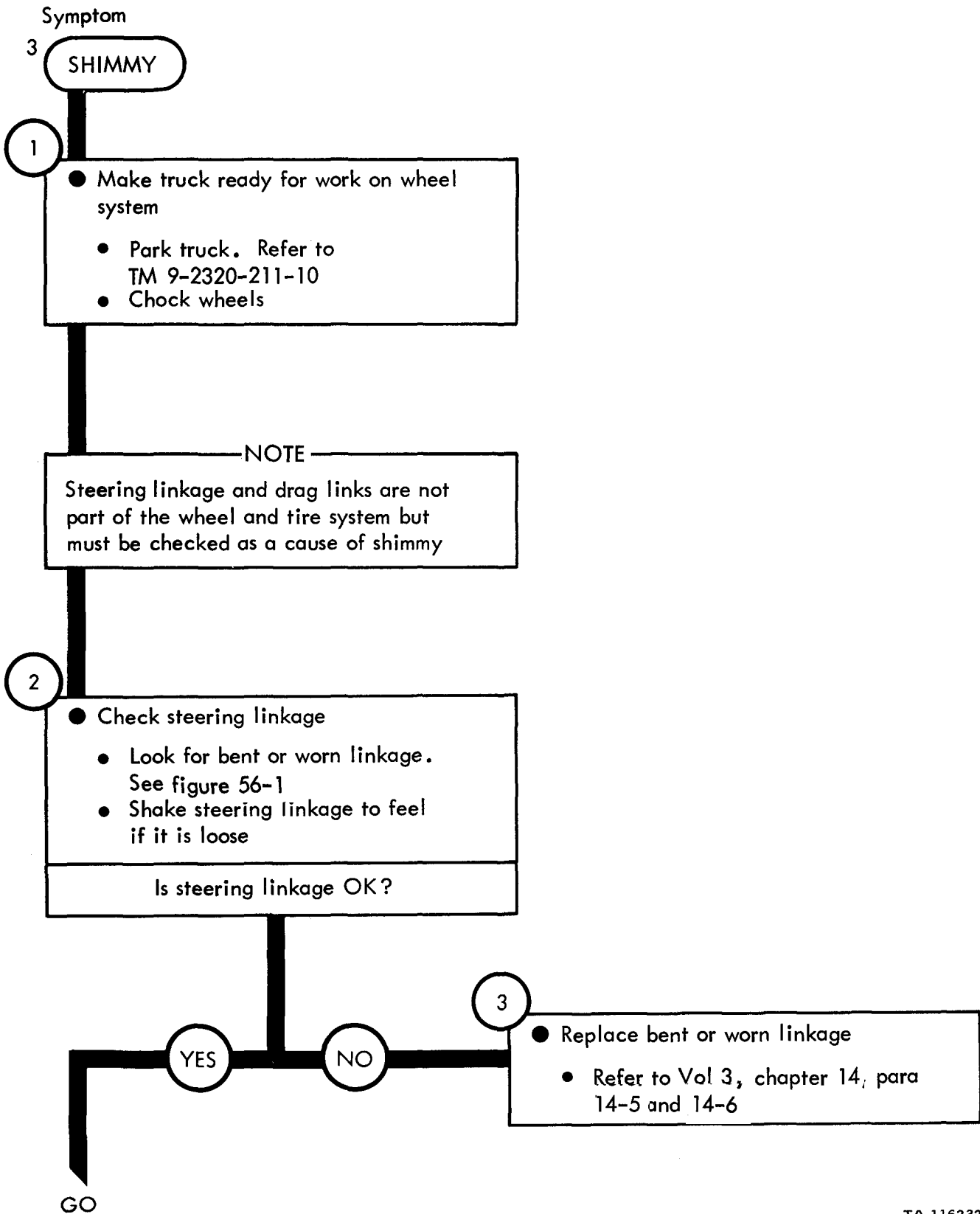
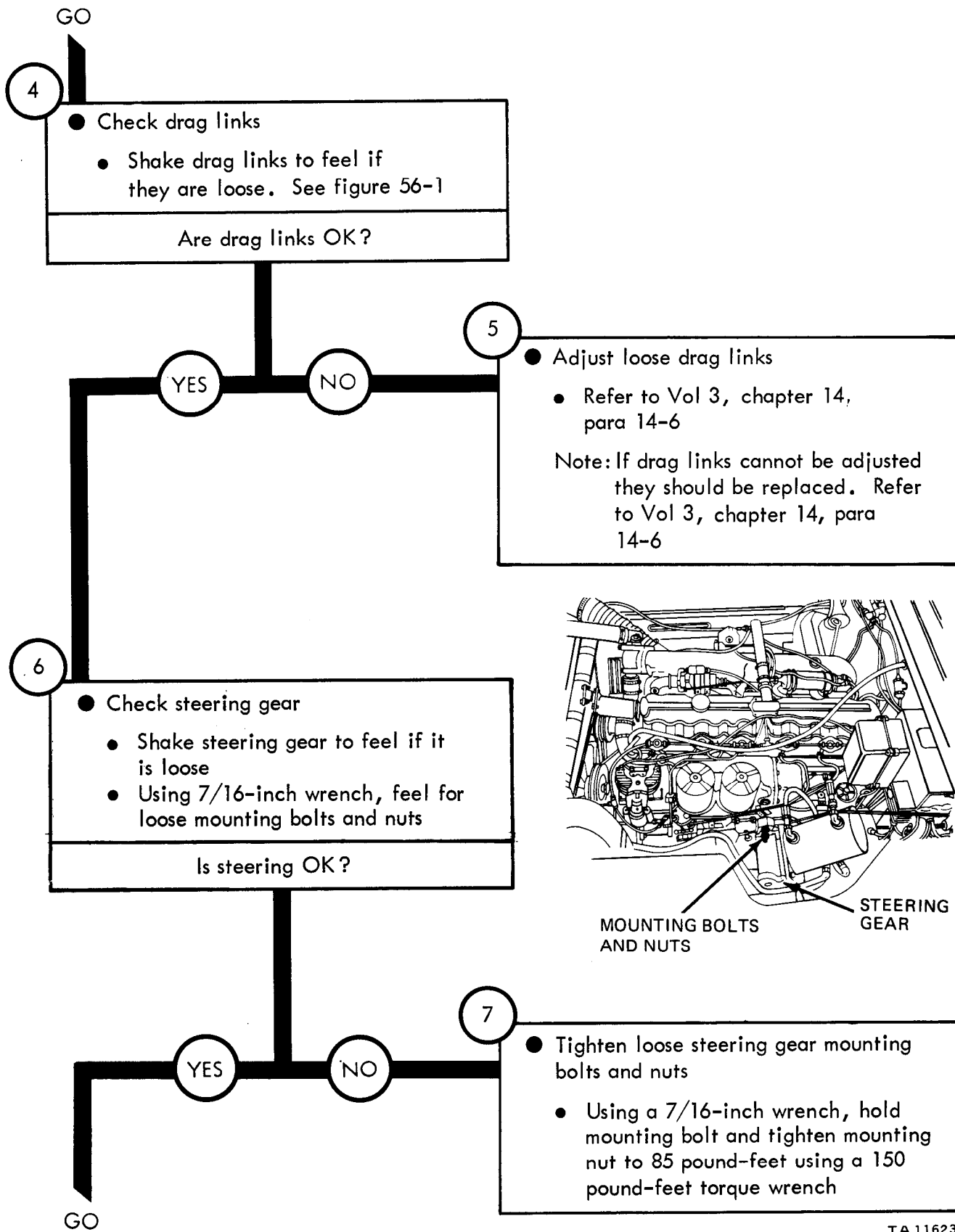

Figure 51-3 (Sheet 1 of 4)

TA 116232



TA 116233

Figure 51-3 (Sheet 2 of 4)

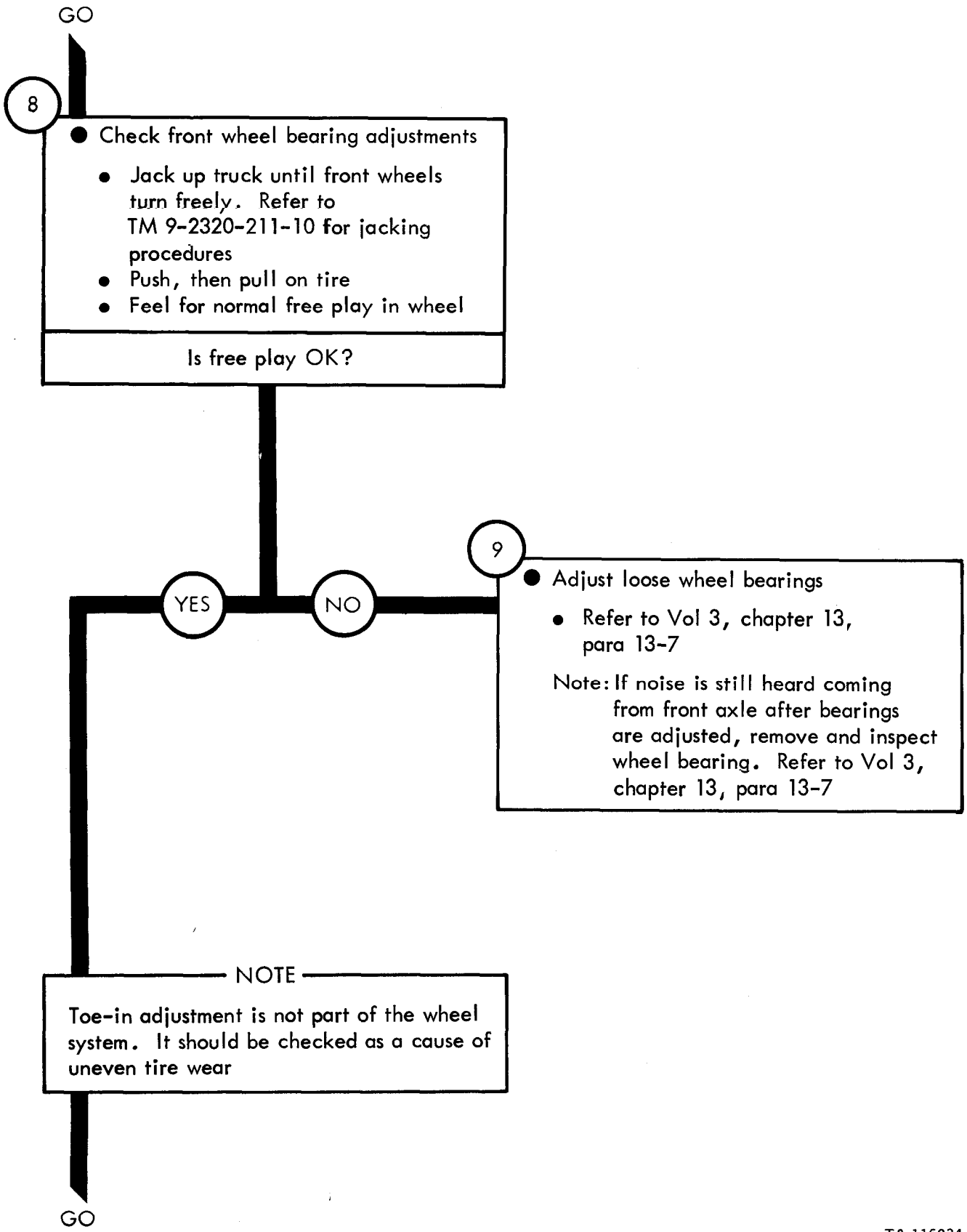

Figure 51-3 (Sheet 3 of 4)

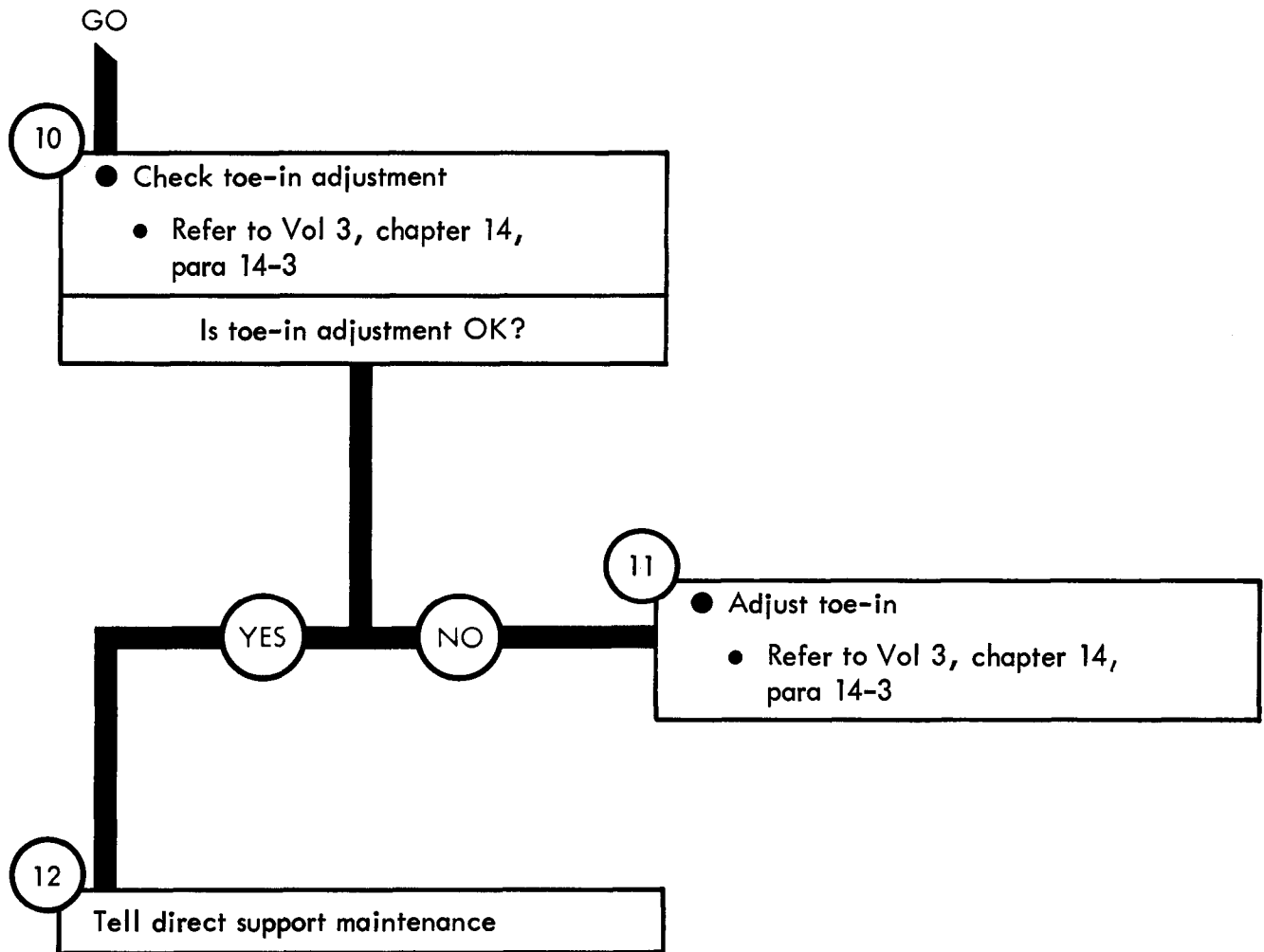

Figure 51-3 (Sheet 4 of 4)

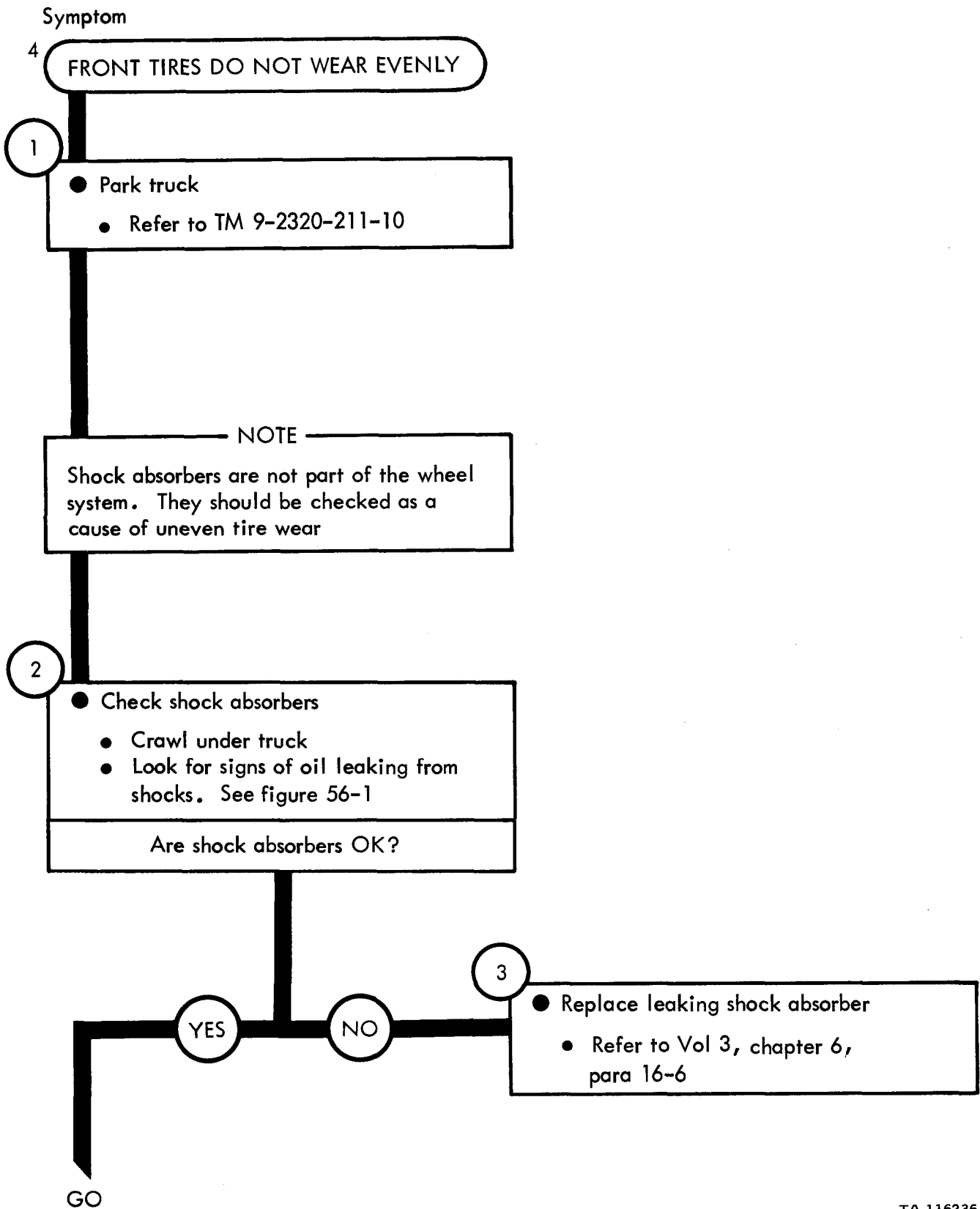

Figure 51-4 (Sheet 1 of 2)

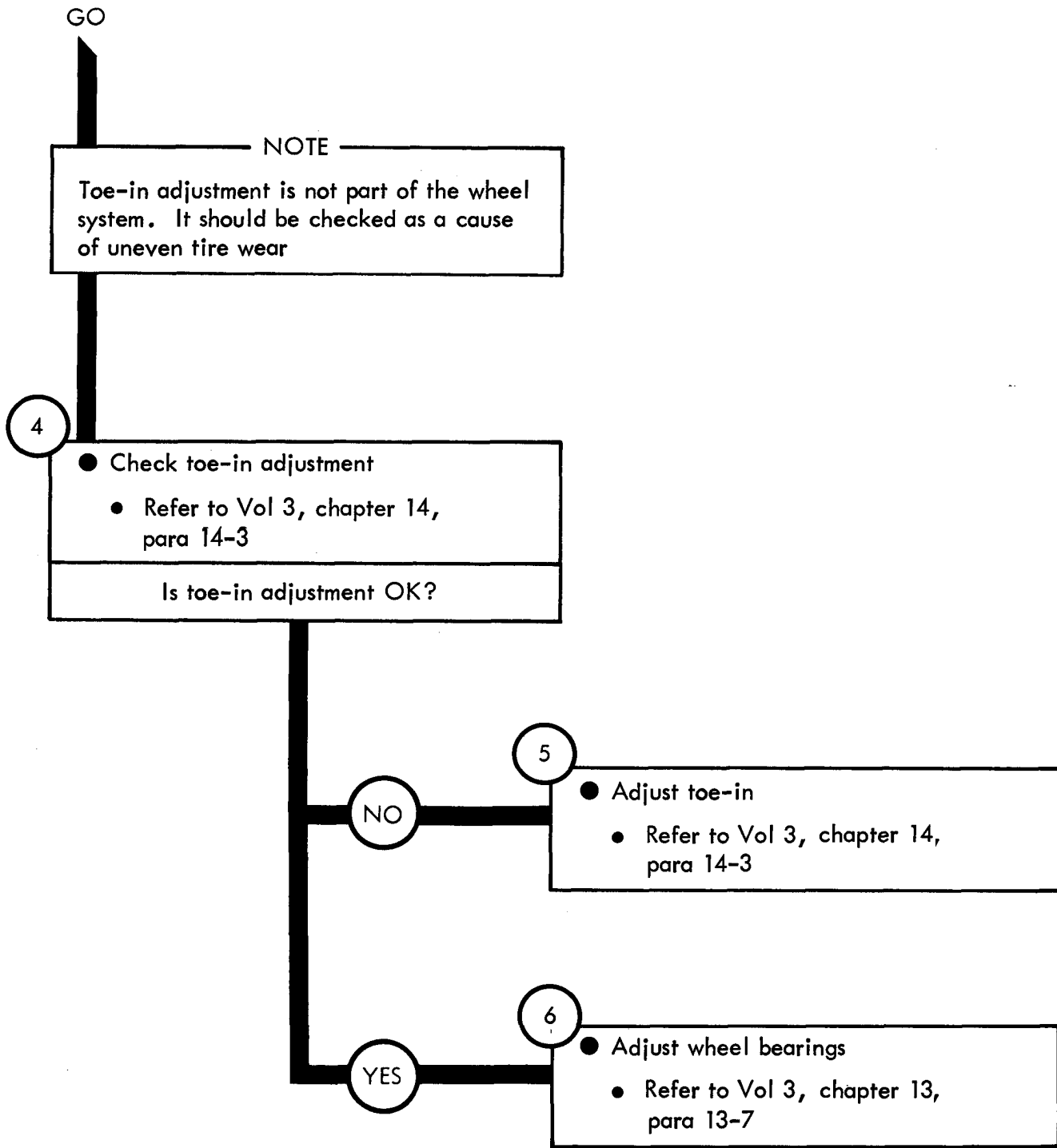

Figure 51-4 (Sheet 2 of 2)

CHAPTER 52

WHEEL SYSTEM TROUBLESHOOTING SUMMARY

52-1. GENERAL. This chapter gives a summary of troubleshooting procedures given in chapter 51, for the Wheel System.

52-2. PROCEDURES. The summary in this chapter covers all fault symptoms found in the detailed troubleshooting procedures. Chapter 7 outlines a sample troubleshooting procedure. The summary procedures are based on the "what-to-do" portions of the detailed procedures and do not include the "How-to-do-it" instructions. Warnings, cautions, and notes are given where needed.

WHEEL SYSTEM TROUBLESHOOTING SUMMARY

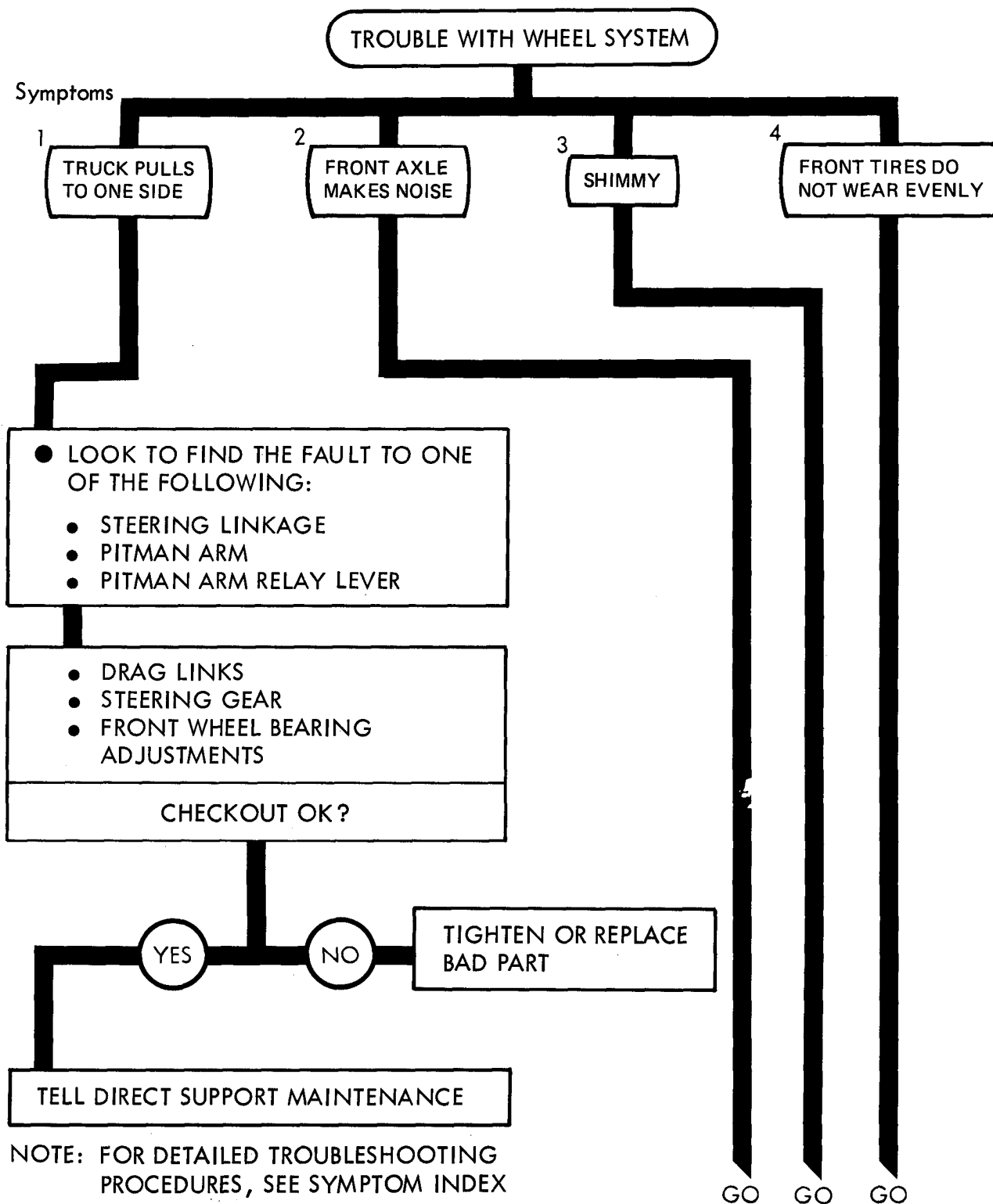

Figure 52-1 (Sheet 1 of 3)

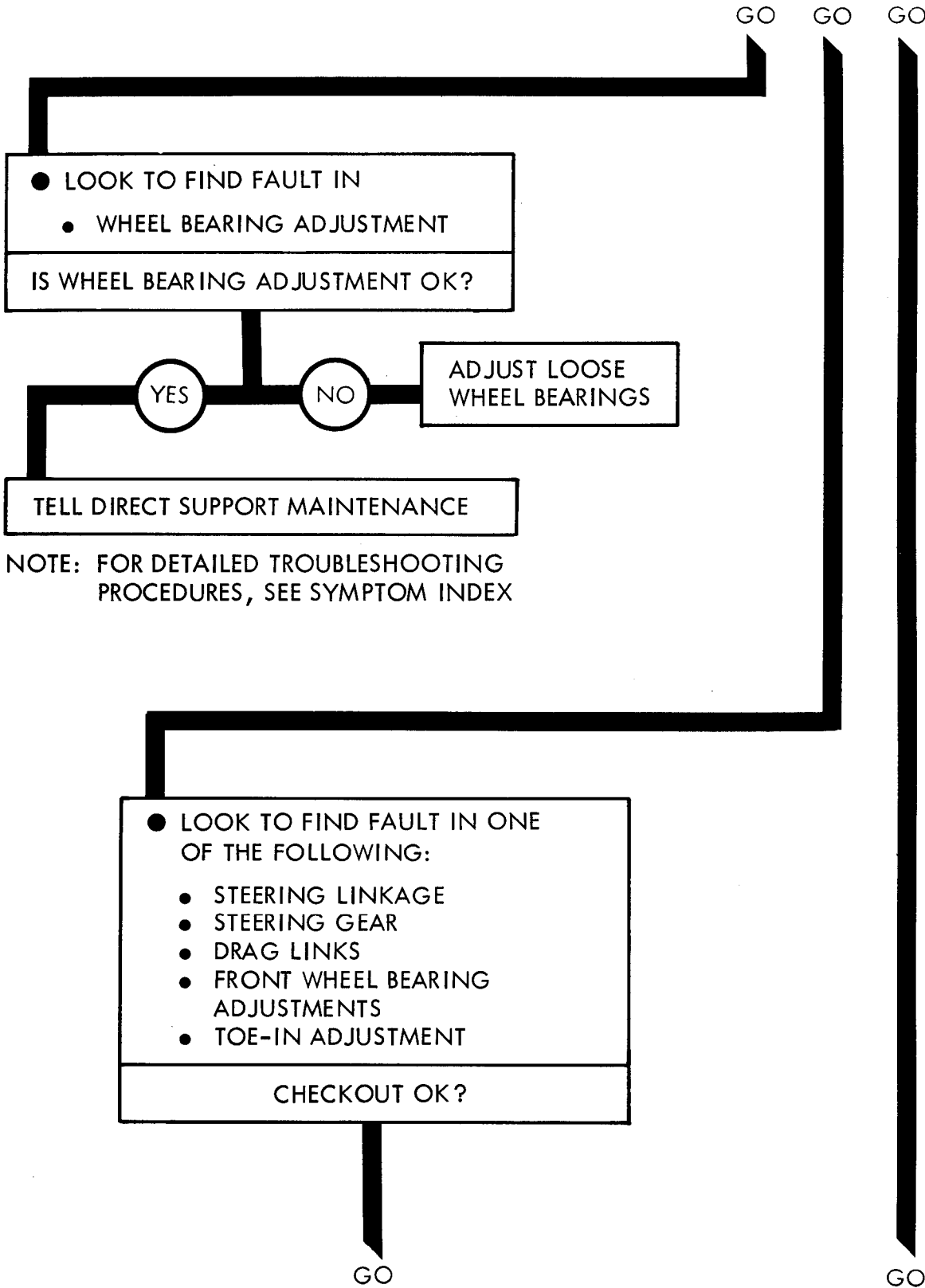

Figure 52-1 (Sheet 2 of 3)

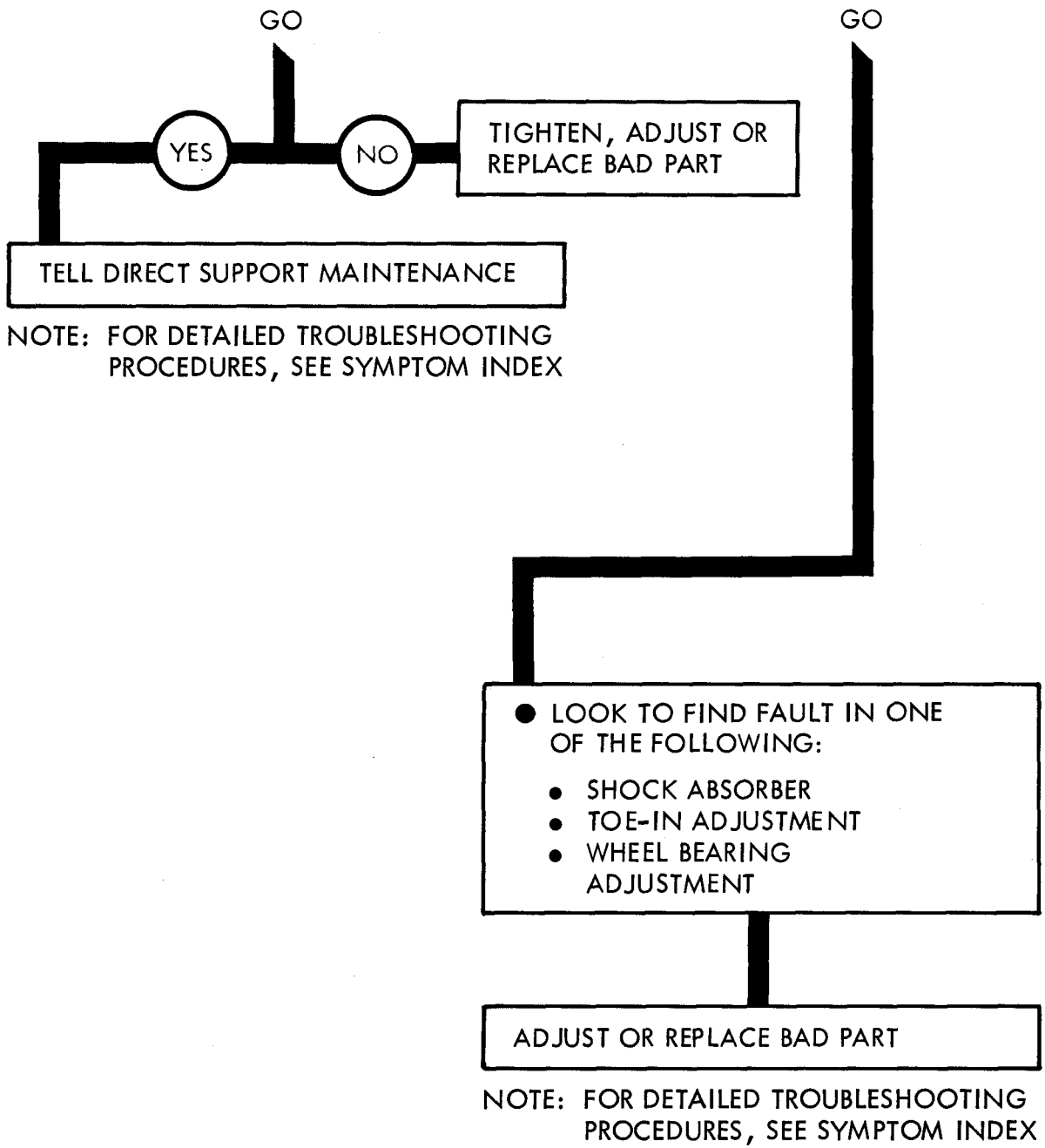

Figure 52-1 (Sheet 3 of 3)

CHAPTER 53

WHEEL SYSTEM CHECKOUT PROCEDURES

53-1. GENERAL. This chapter gives procedures for checking out the system after troubleshooting and repair have been done. Procedures are set up in flow chart form showing the checkout steps in order and referring to the fault symptom index when the system does not checkout.

WHEEL SYSTEM CHECKOUT

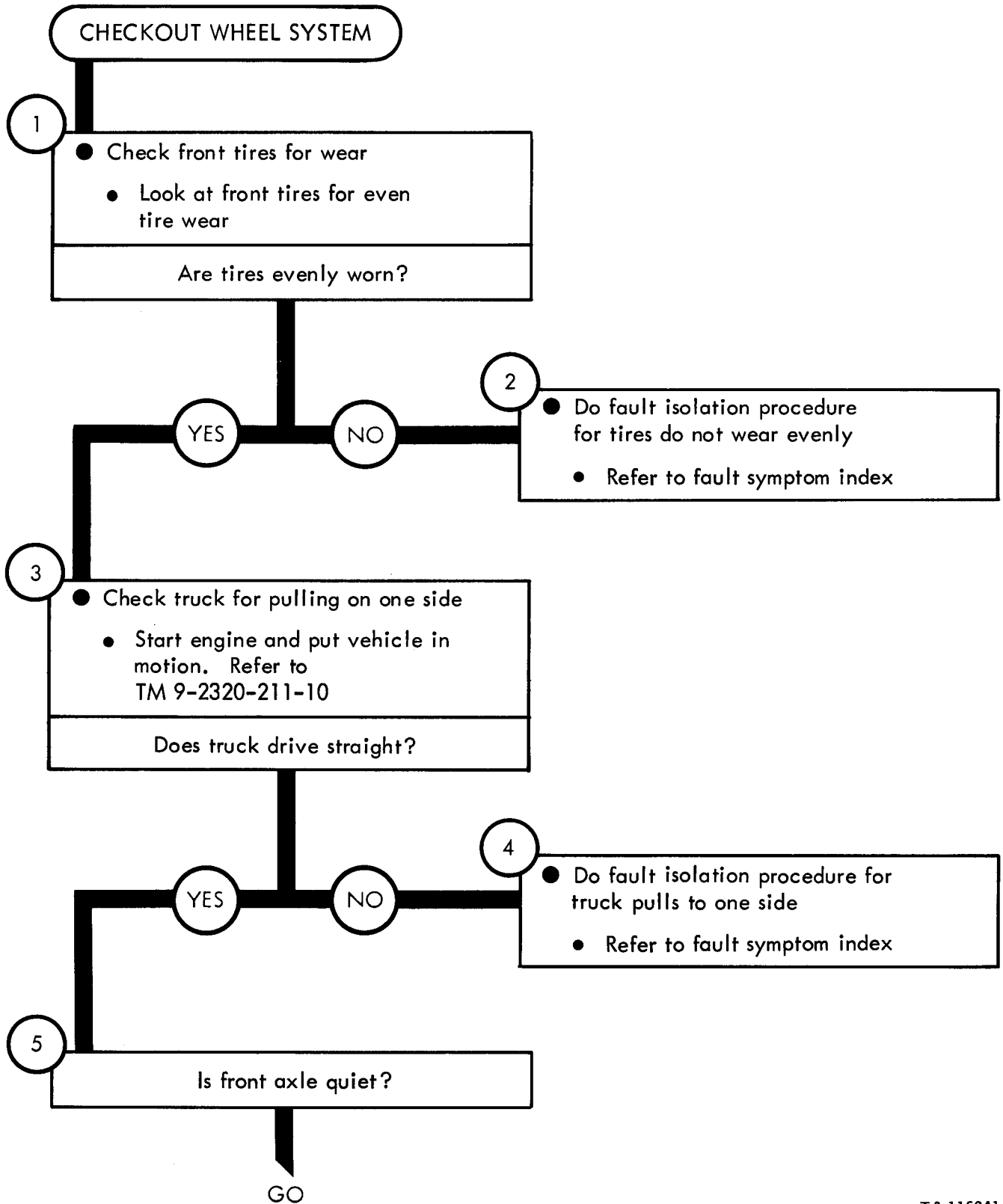

Figure 53-1 (Sheet 1 of 2)

TA 116241

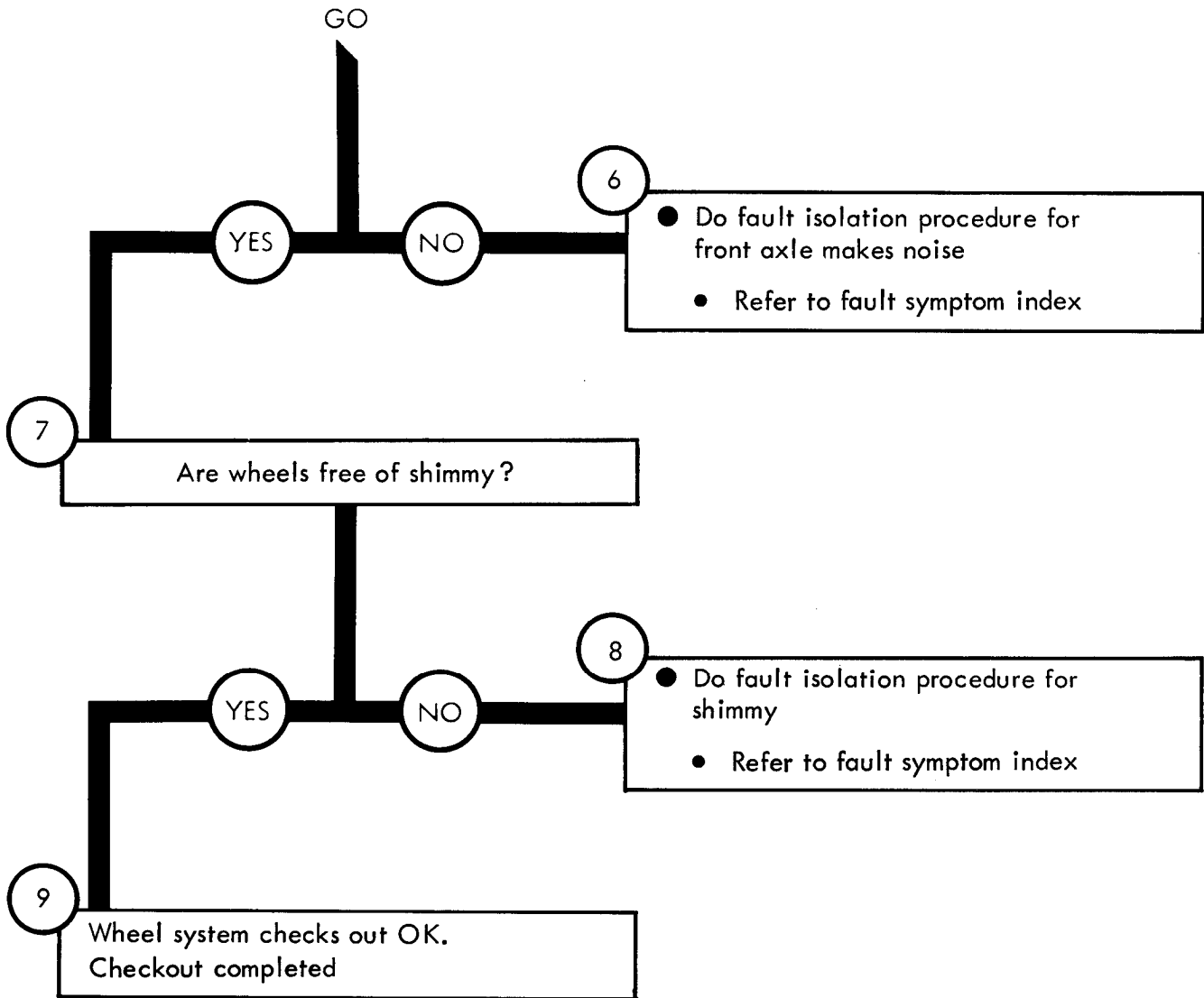

Figure 53-2 (Sheet 2 of 2)

CHAPTER 54

STEERING SYSTEM TROUBLESHOOTING

54-1. EQUIPMENT ITEMS COVERED. This chapter gives equipment troubleshooting procedures for the steering system, for which there are authorized corrective maintenance tasks at the organizational maintenance level.

54-2. EQUIPMENT ITEMS NOT COVERED. All equipment items for which corrective maintenance is authorized at the organizational maintenance level are covered in this chapter.

STEERING SYSTEM TROUBLESHOOTING

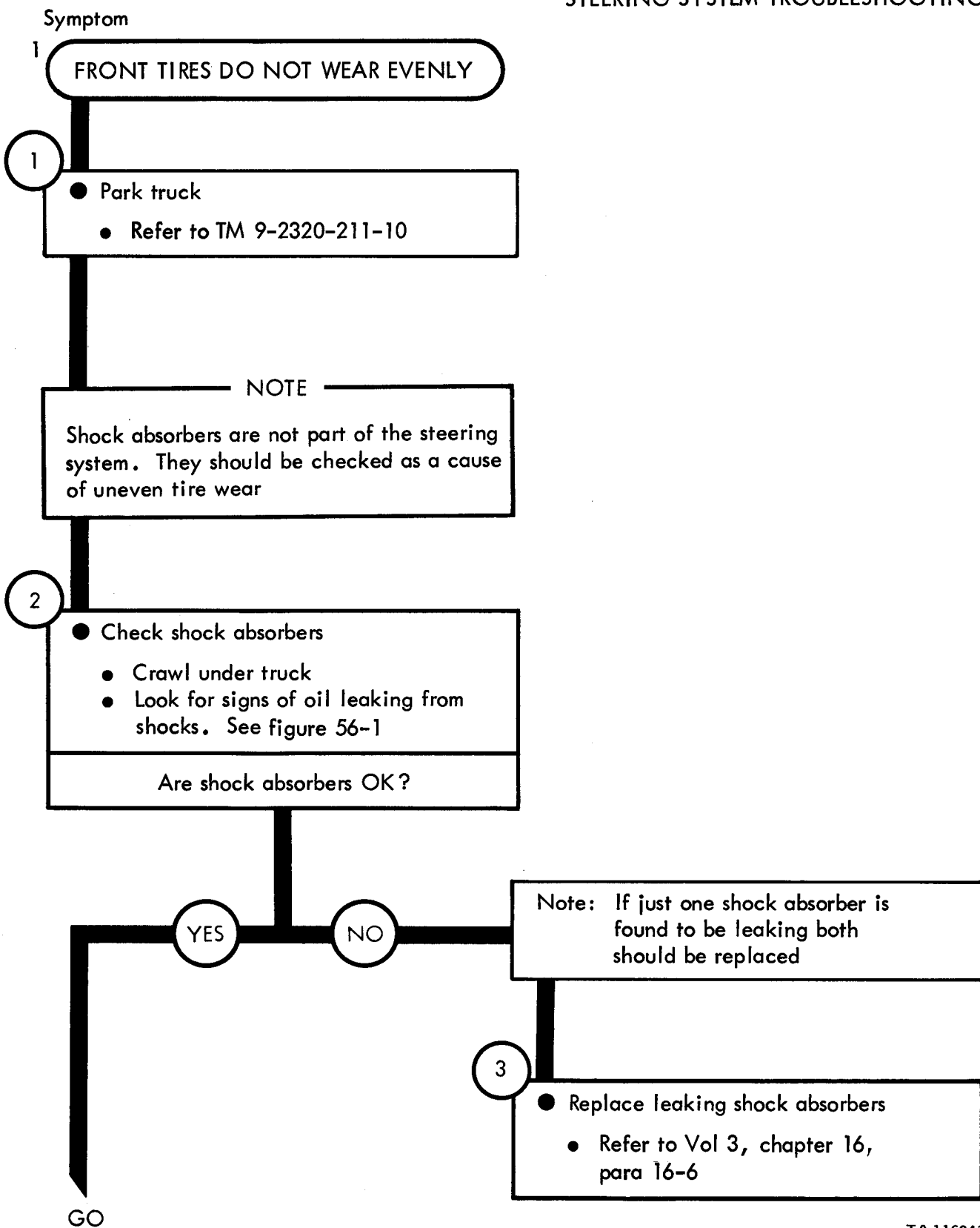

Figure 54-1 (Sheet 1 of 2)

TA 116243

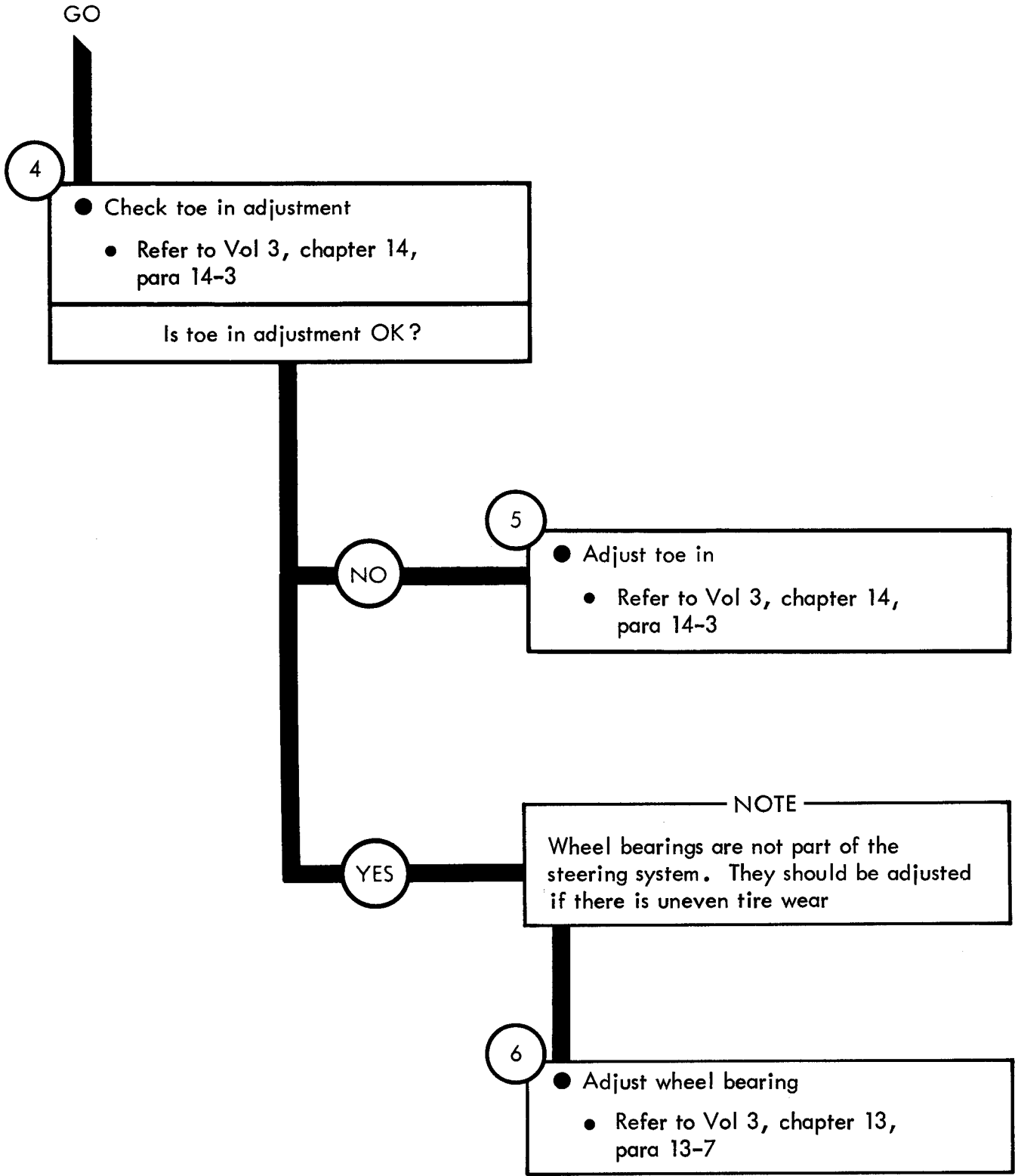

Figure 54-1 (Sheet 2 of 2)

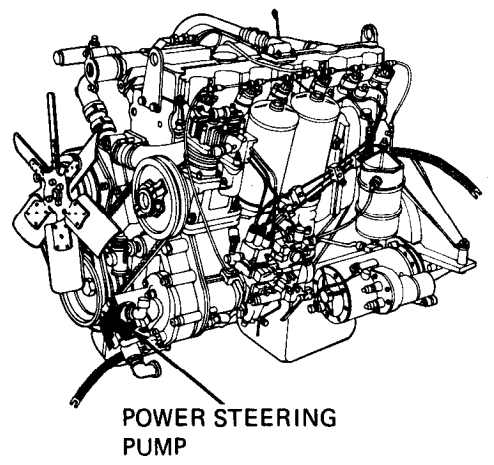
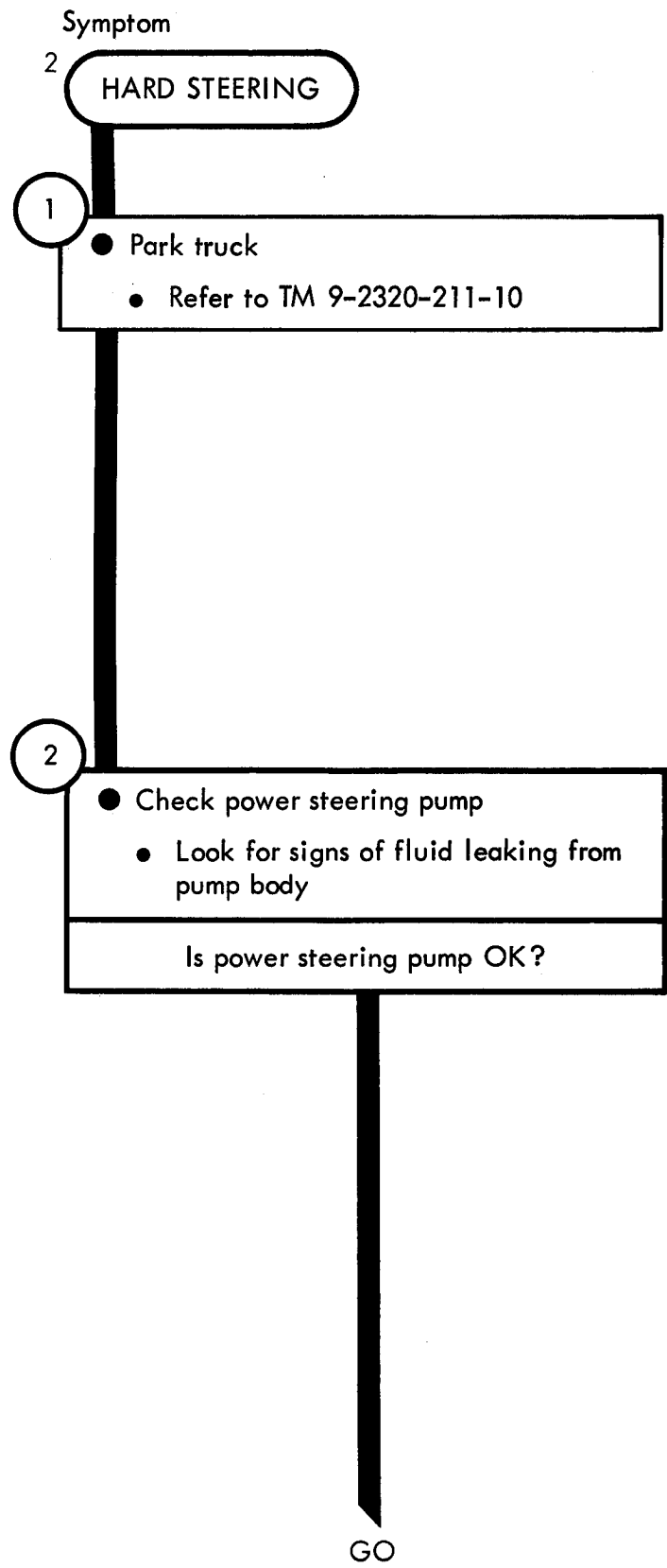

Figure 54-2 (Sheet 1 of 4)

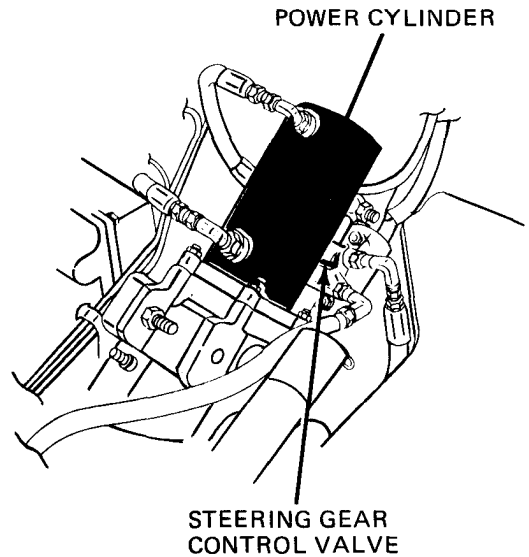
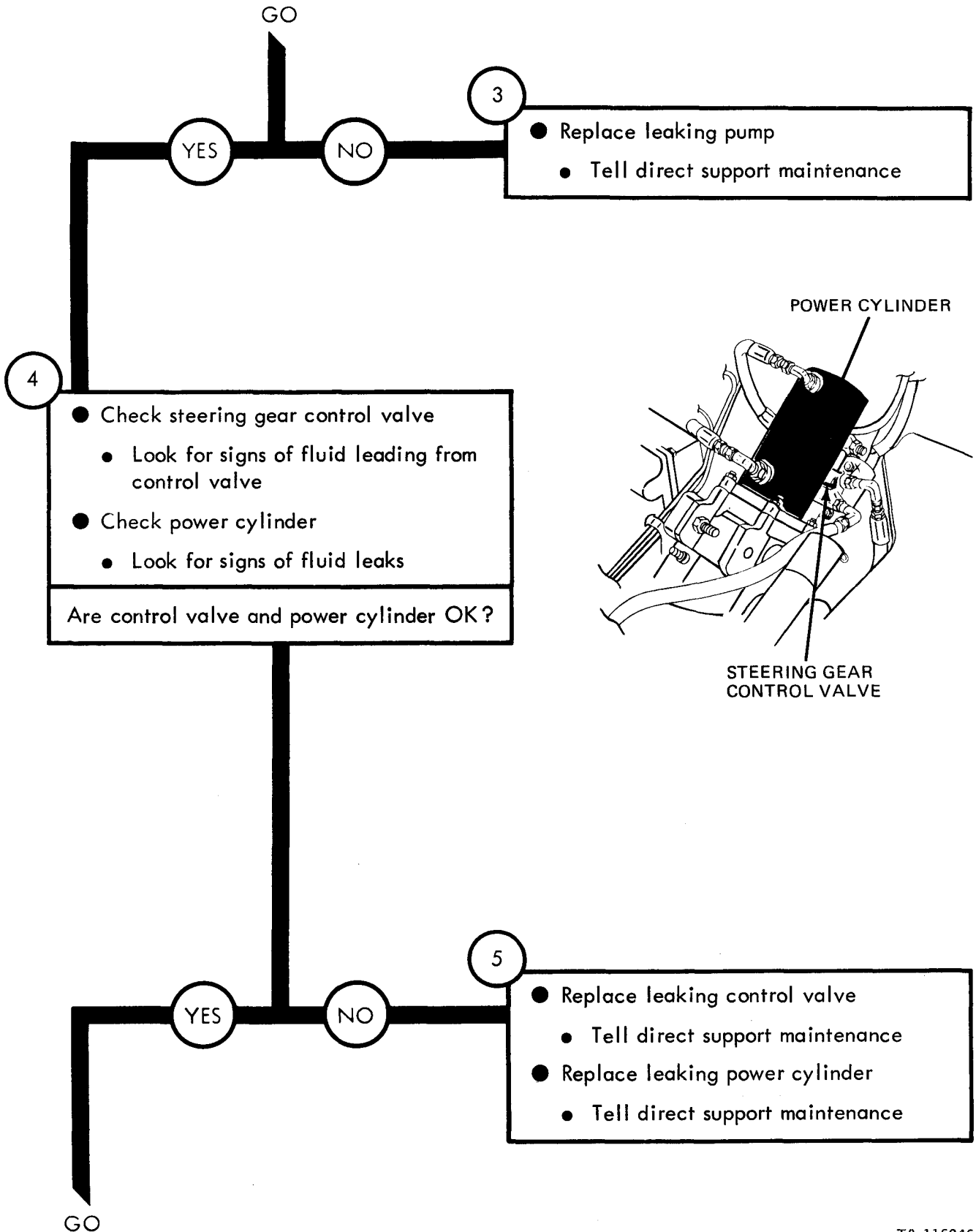

Figure 54-2 (Sheet 2 of 4)

TA 116246

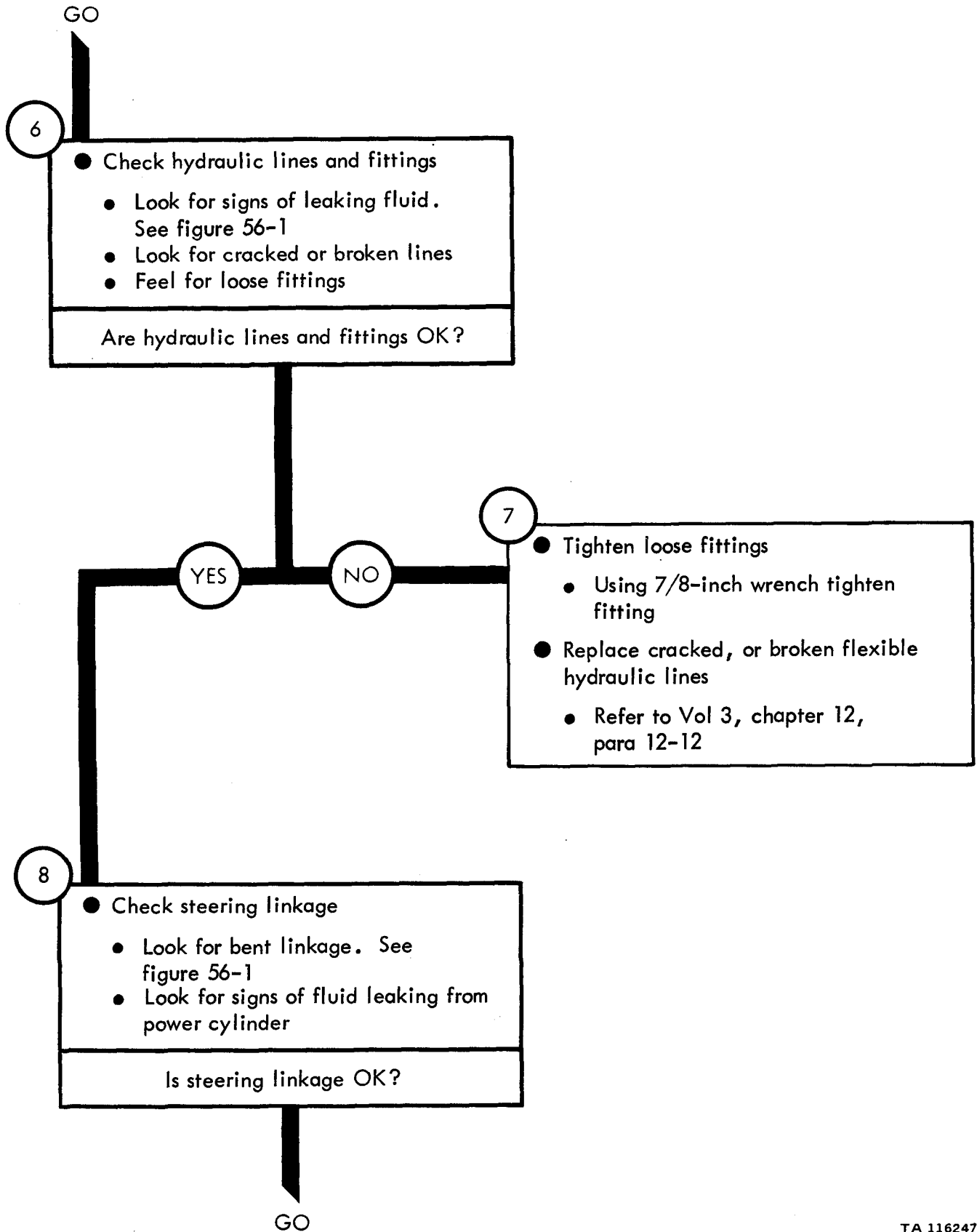

Figure 54-2 (Sheet 3 of 4)

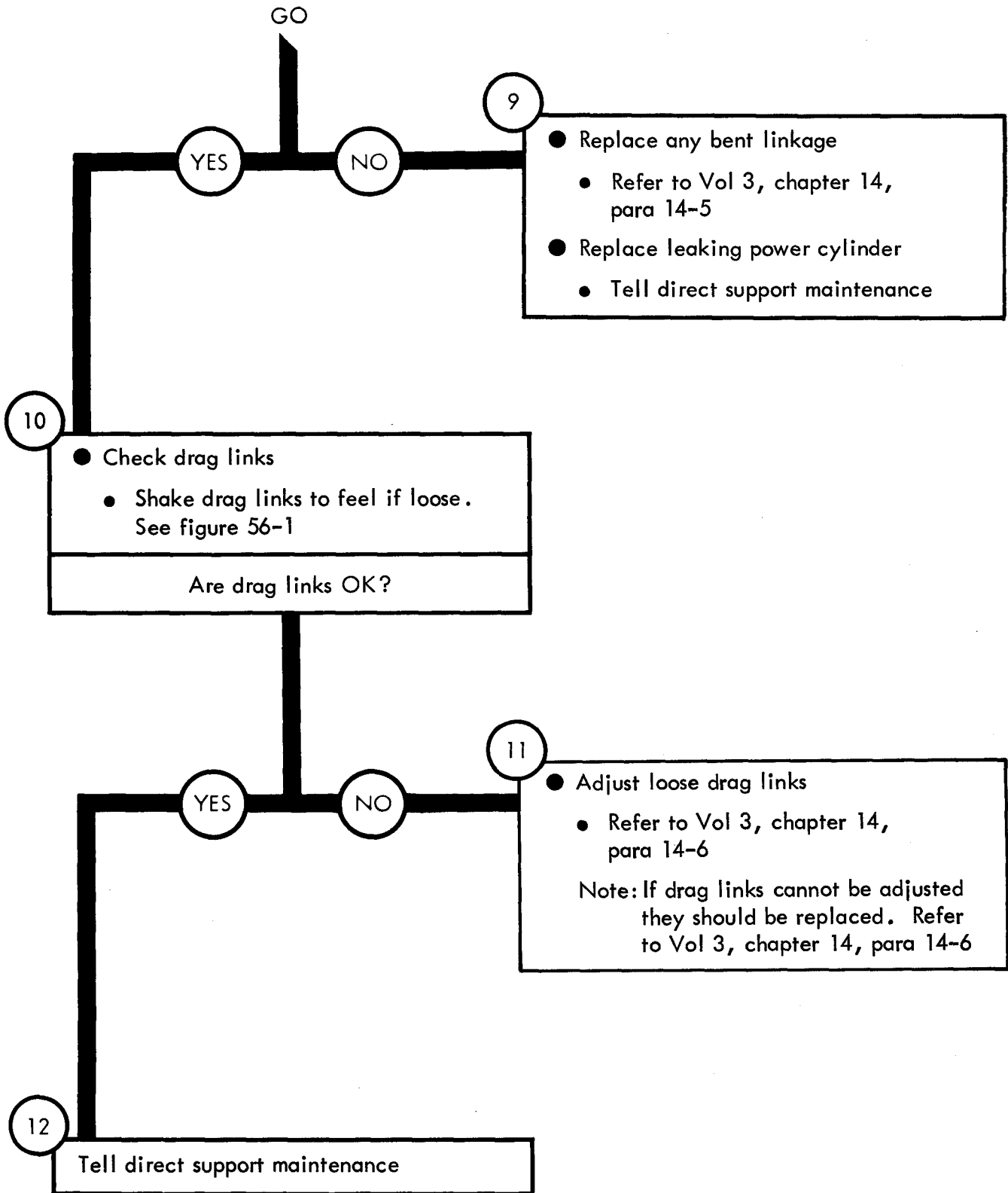

Figure 54-2 (Sheet 4 of 4)

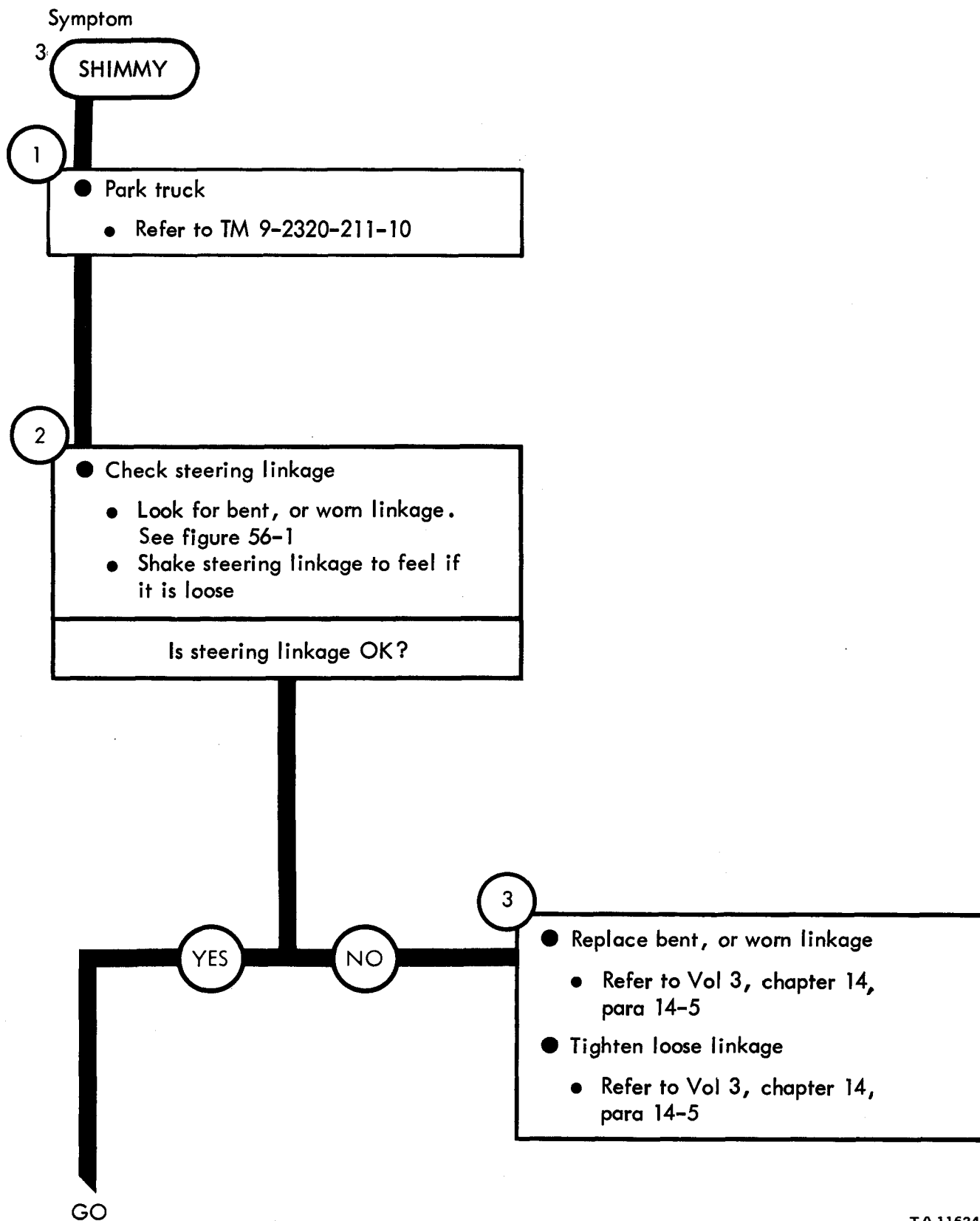

Figure 54-3 (Sheet 1 of 5)

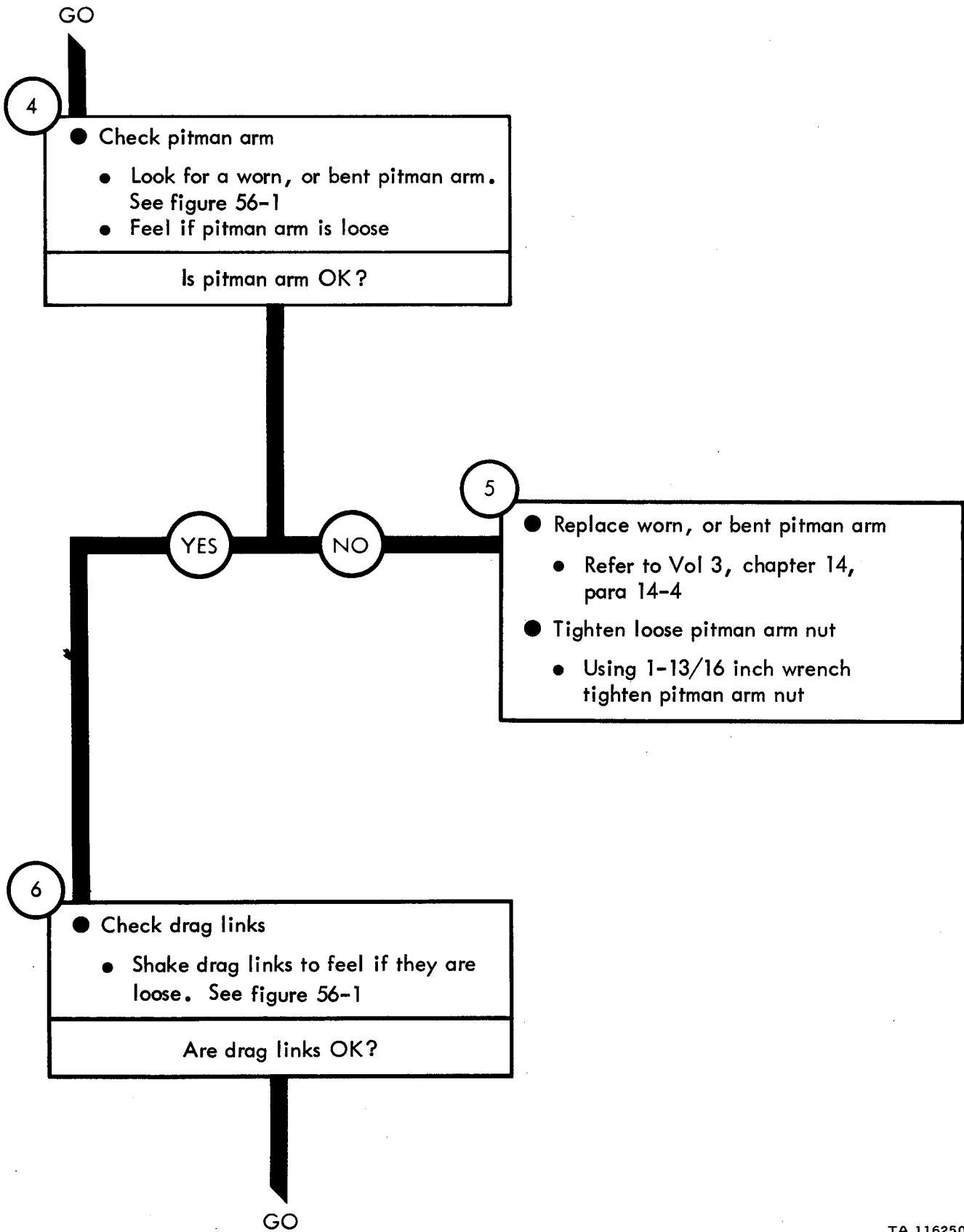

Figure 54-3 (Sheet 2 of 5)

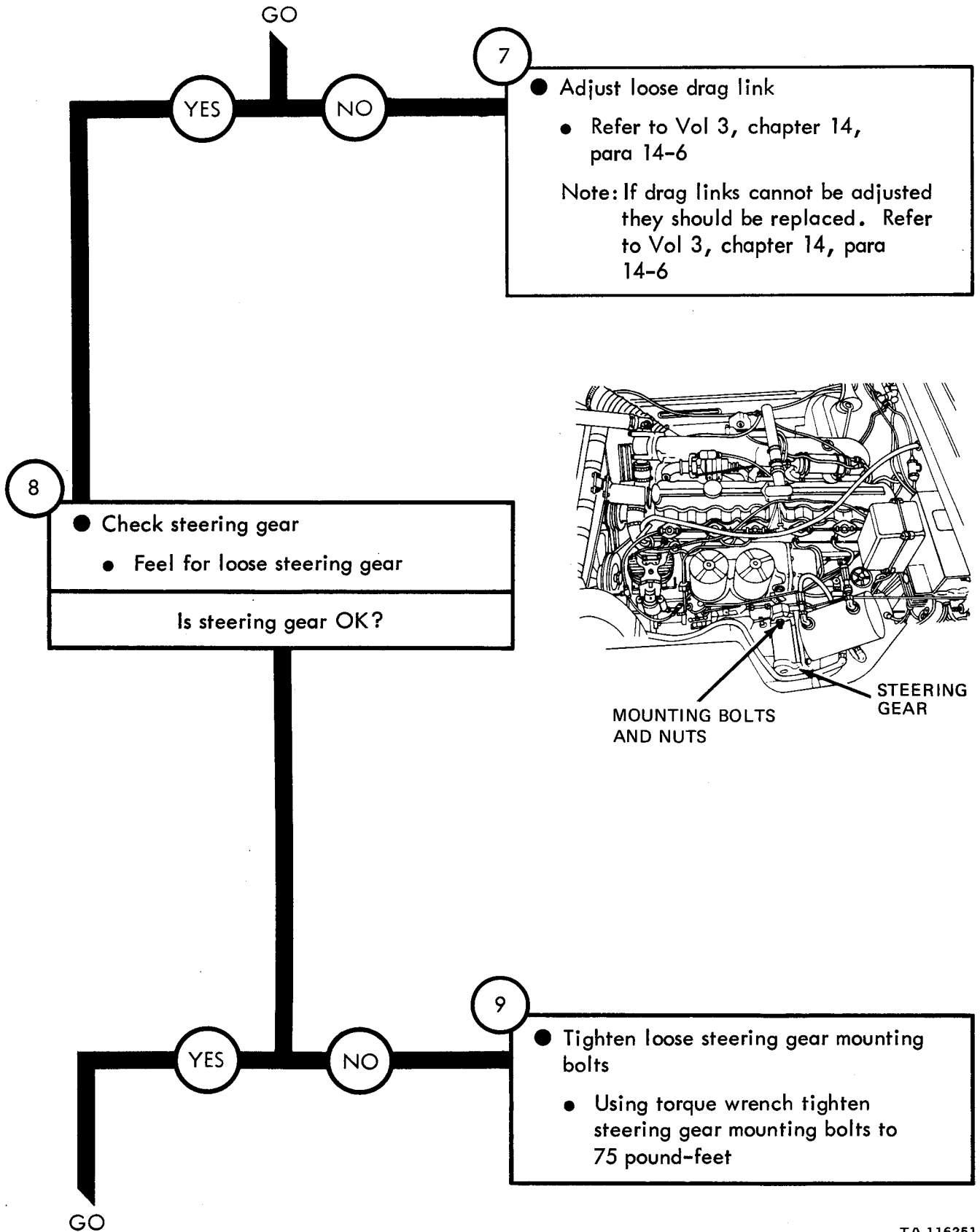

Figure 54-3 (Sheet 3 of 5)

TA 116251

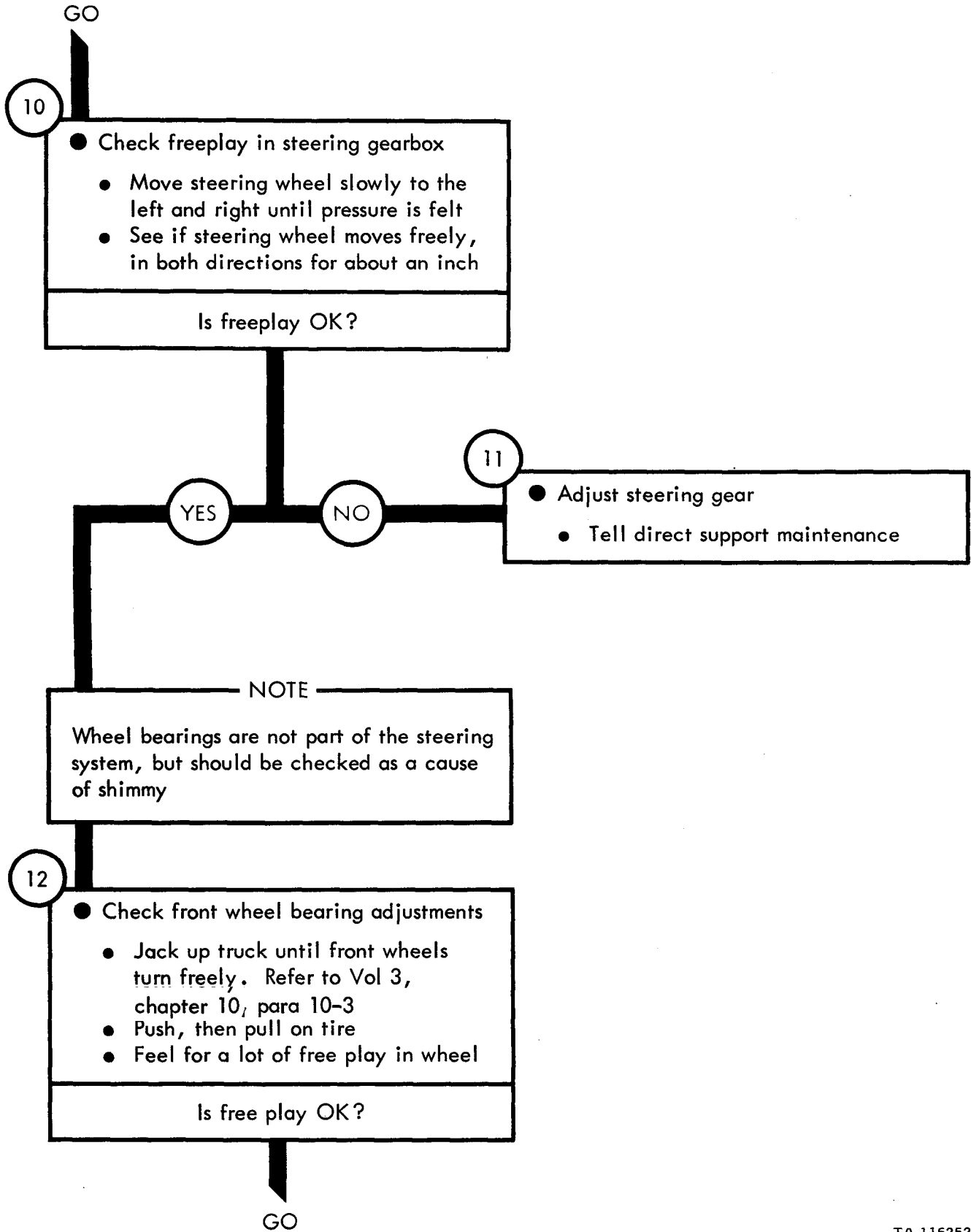

Figure 54-3 (Sheet 4 of 5)

TA 116252

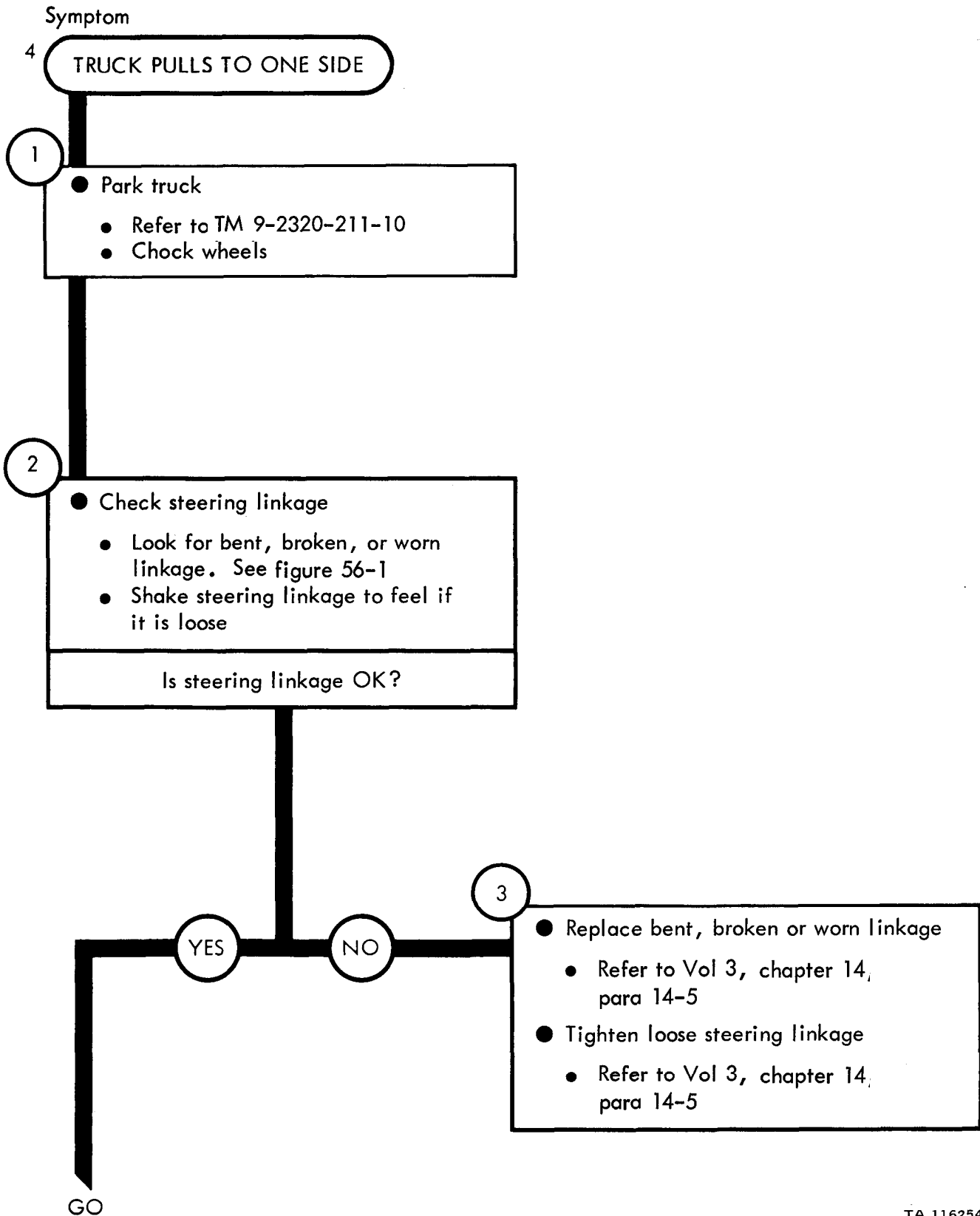

Figure 54-4 (Sheet 1 of 4)

TA 116254

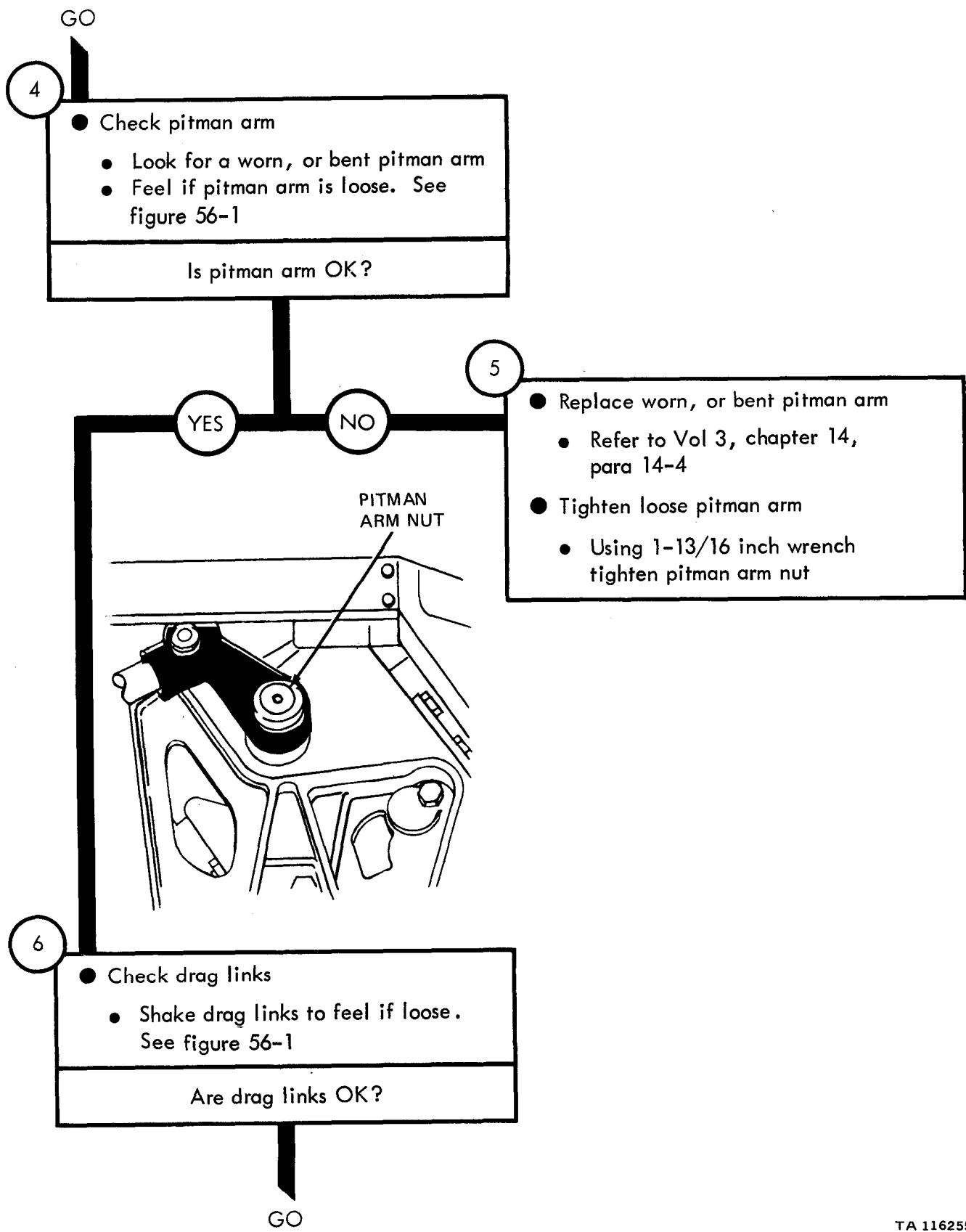

Figure 54-4 (Sheet 2 of 4)

TA 116255

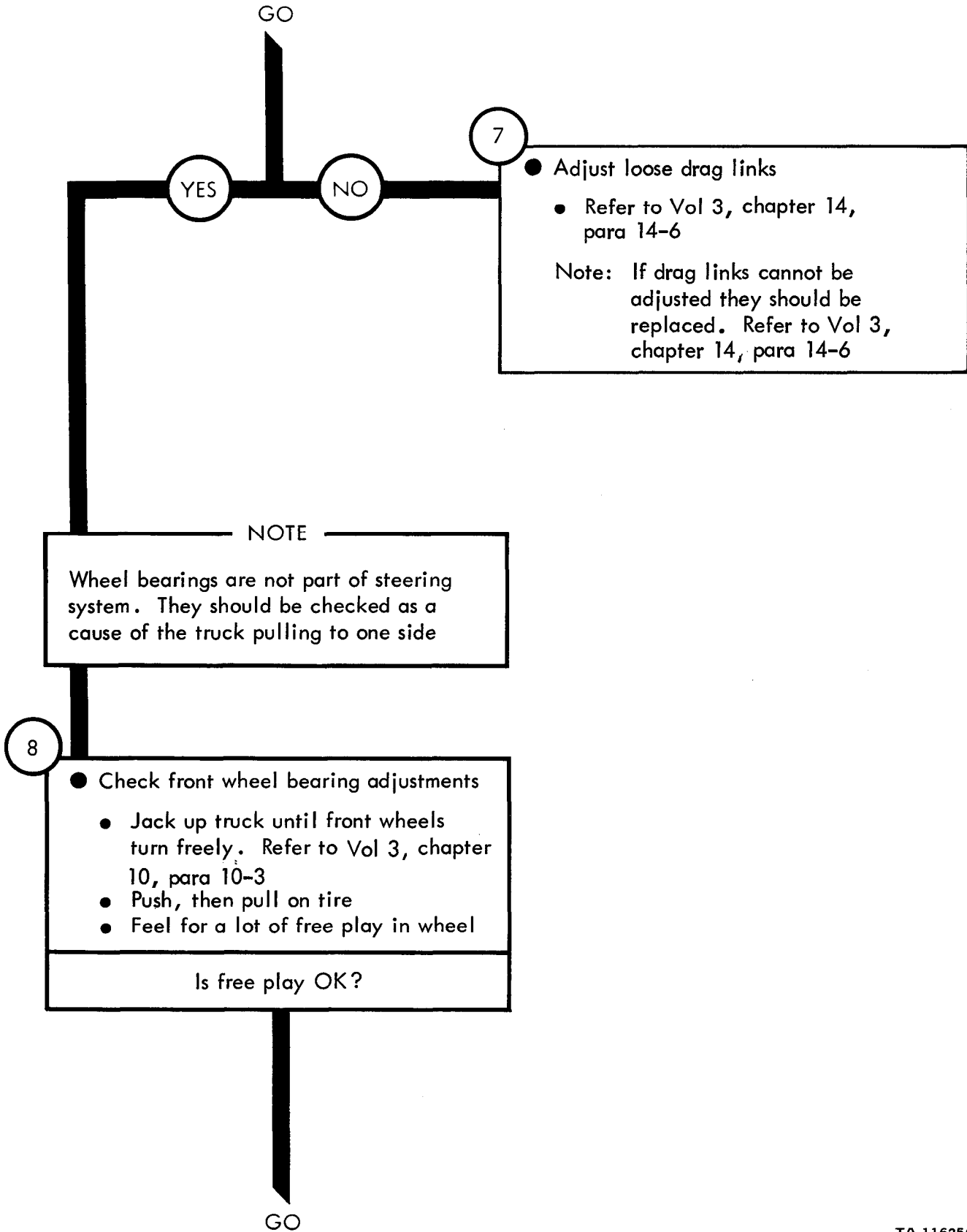

Figure 54-4 (Sheet 3 of 4)

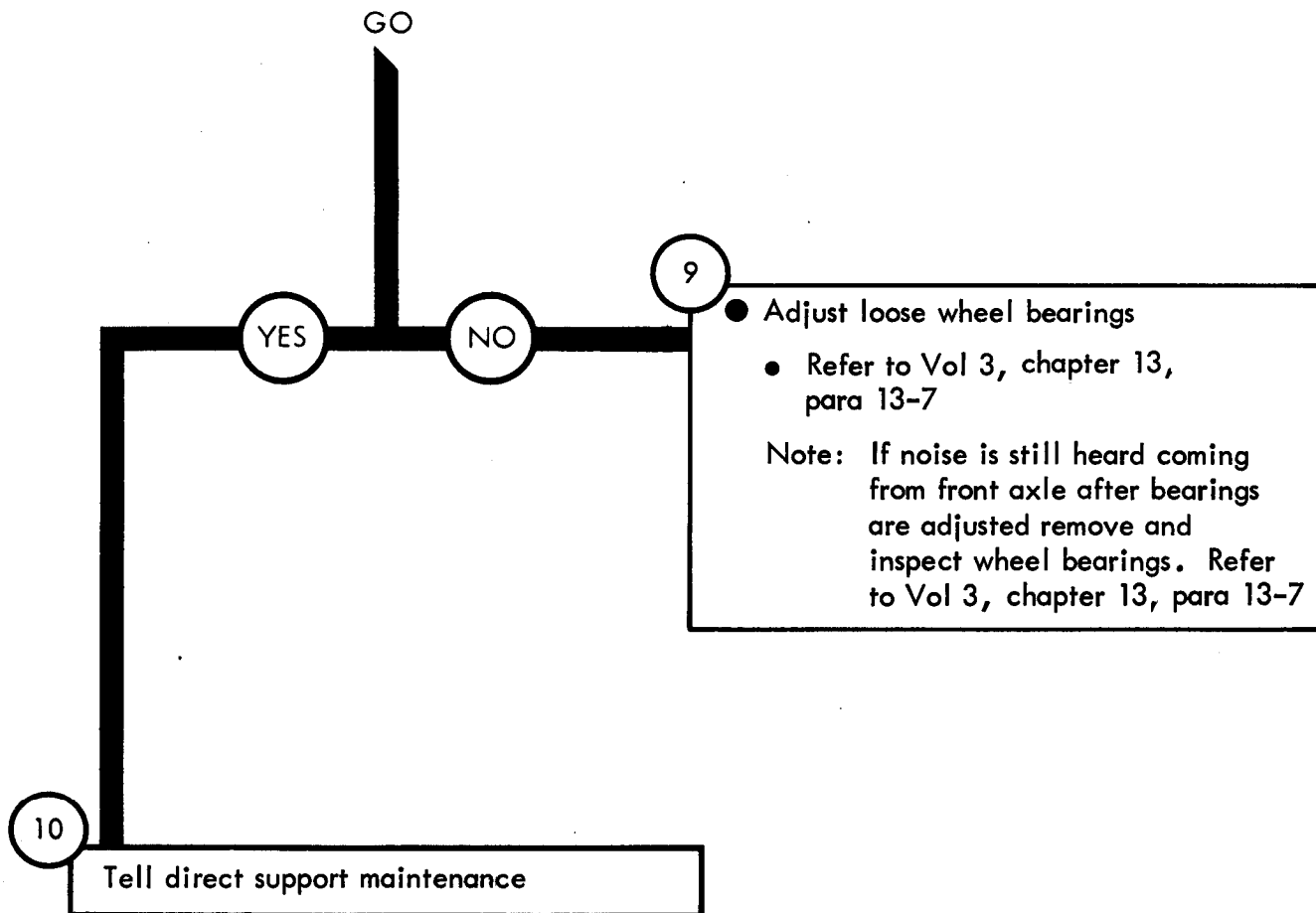

Figure 54-4, (Sheet 4 of 4)

CHAPTER 55

STEERING SYSTEM TROUBLESHOOTING SUMMARY

55-1. GENERAL. This chapter gives a summary of troubleshooting procedures given in chapter 54, for the Steering System.

55-2. PROCEDURES. The summary in this chapter covers all fault symptoms found in the detailed troubleshooting procedures. Chapter 7 outlines a sample troubleshooting procedure. The summary procedures are based on the "what-to-do" portions of the detailed procedures and do not include the "How-to-do-it" instructions. Warnings, cautions, and notes are given where needed.

STEERING SYSTEM TROUBLESHOOTING SUMMARY

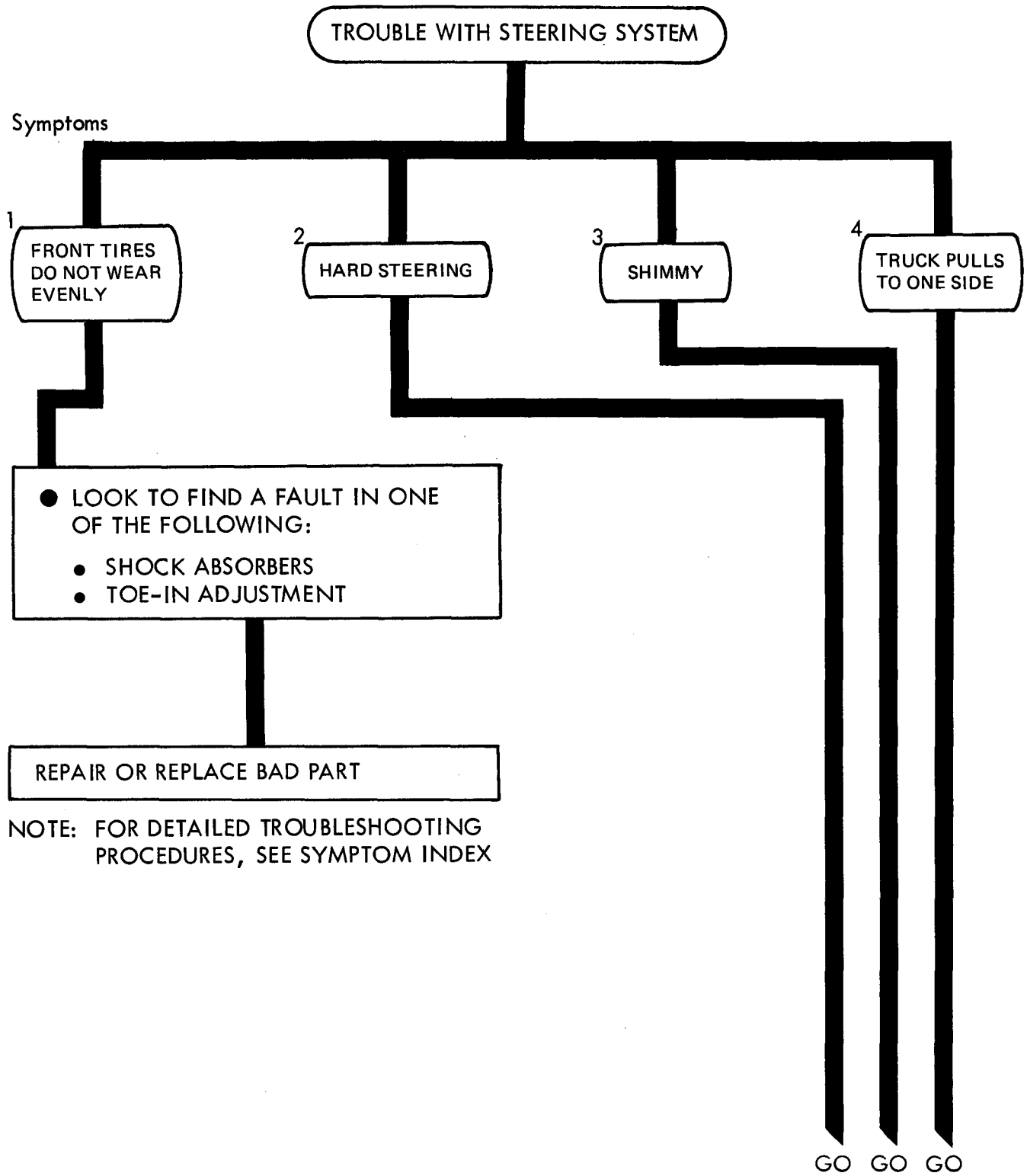

NOTE: FOR DETAILED TROUBLESHOOTING PROCEDURES, SEE SYMPTOM INDEX

Figure 55-1 (Sheet 1 of 4)

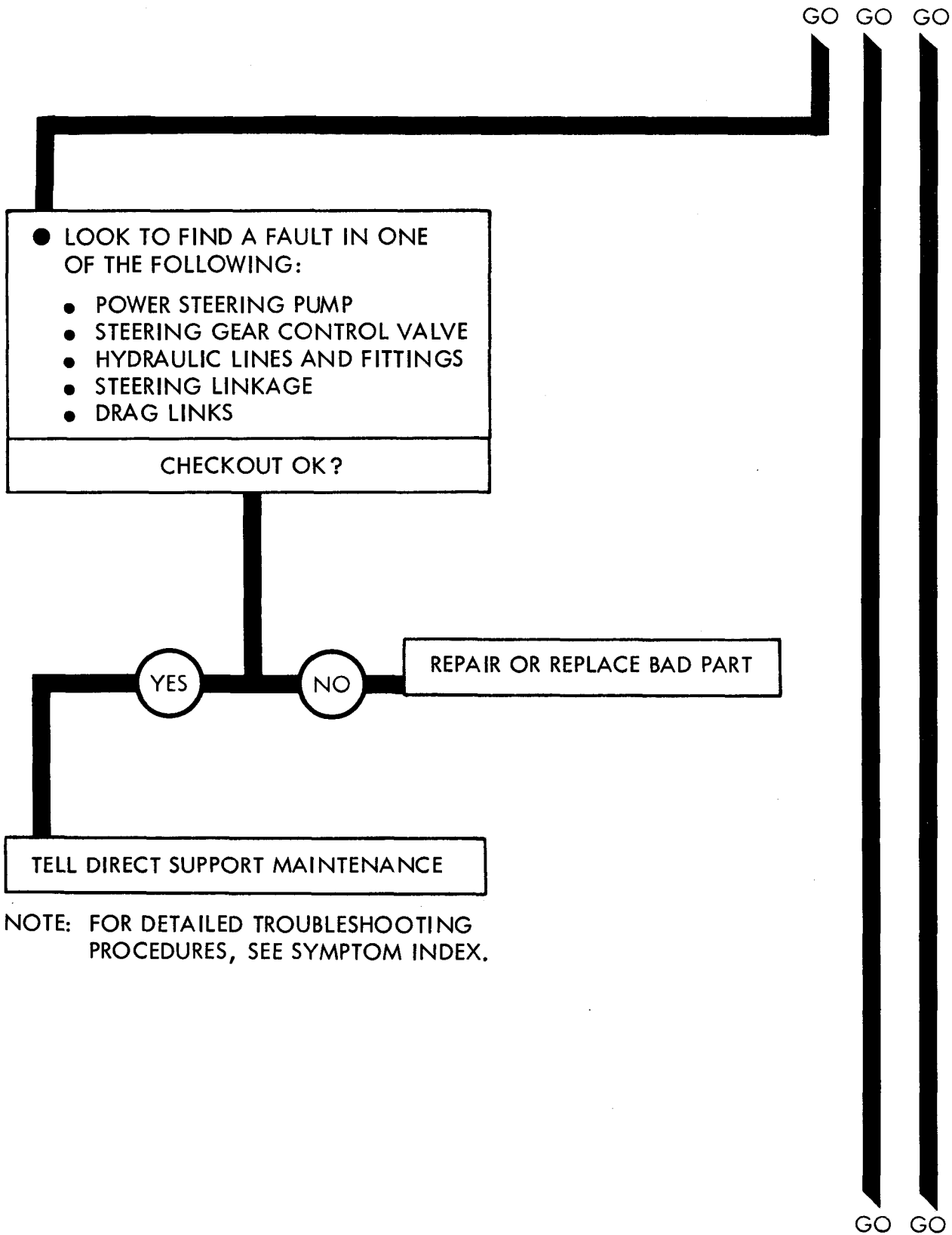

NOTE: FOR DETAILED TROUBLESHOOTING PROCEDURES, SEE SYMPTOM INDEX.

Figure 55-1 (Sheet 2 of 4)

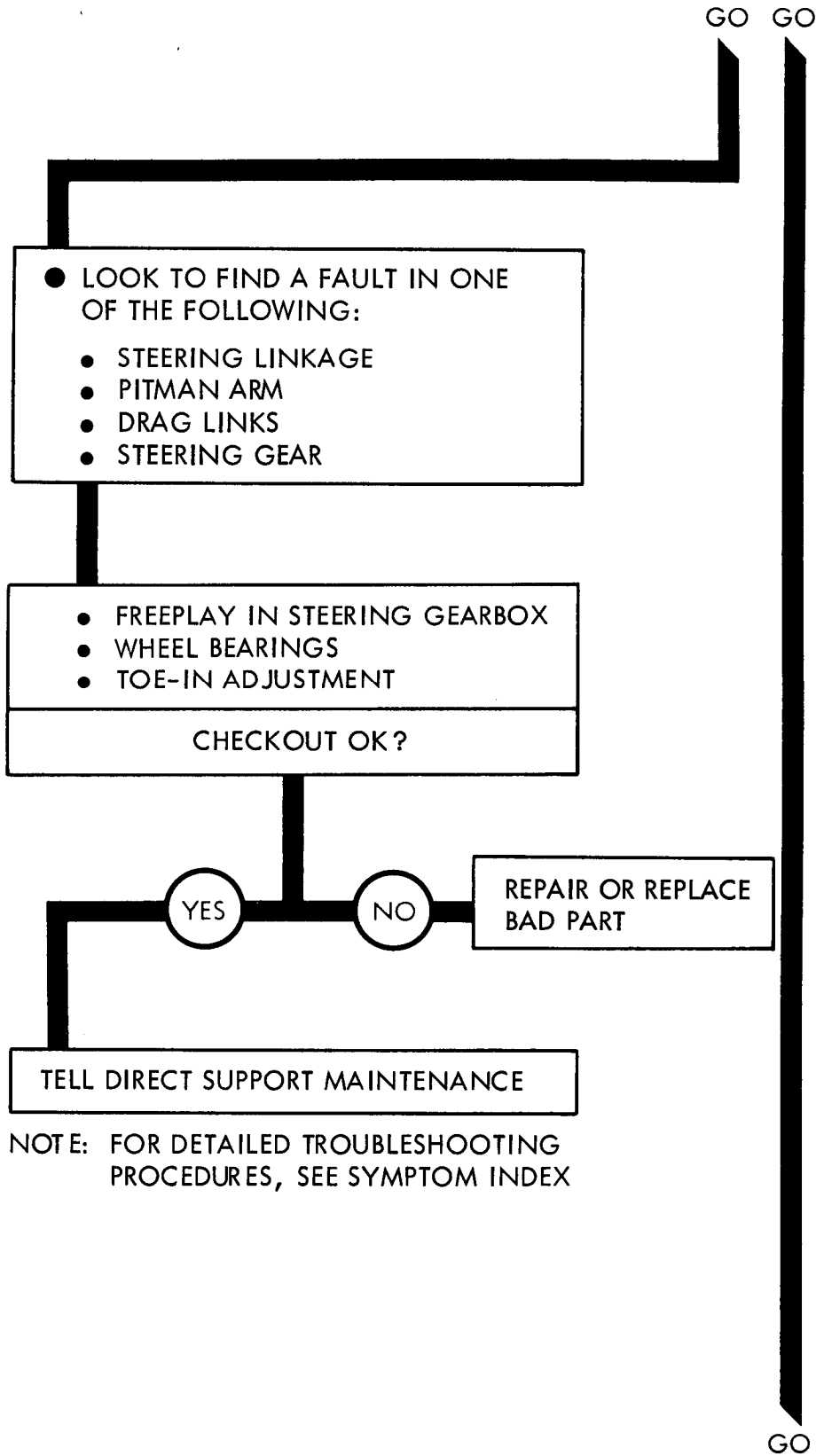

NOTE: FOR DETAILED TROUBLESHOOTING PROCEDURES, SEE SYMPTOM INDEX

Figure 55-1 (Sheet 3 of 4)

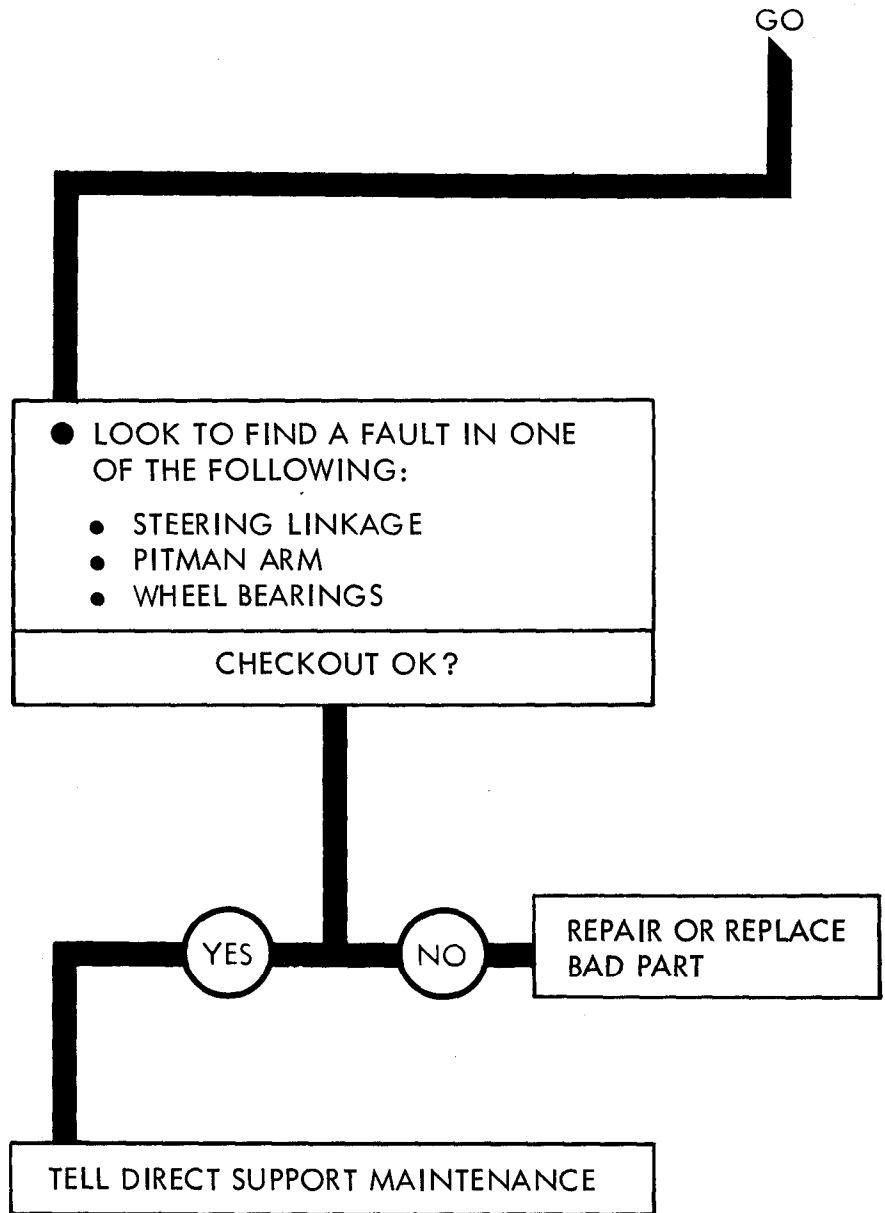

NOTE: FOR DETAILED TROUBLESHOOTING PROCEDURES, SEE SYMPTOM INDEX

Figure 55-1 (Sheet 4 of 4)

TA 116261

CHAPTER 56

STEERING SYSTEM SUPPORT DIAGRAMS

56-1. GENERAL. This chapter gives the diagrams you need when doing troubleshooting procedures in chapter 54. Table 3-1 is a complete listing of all support diagrams used in this manual.

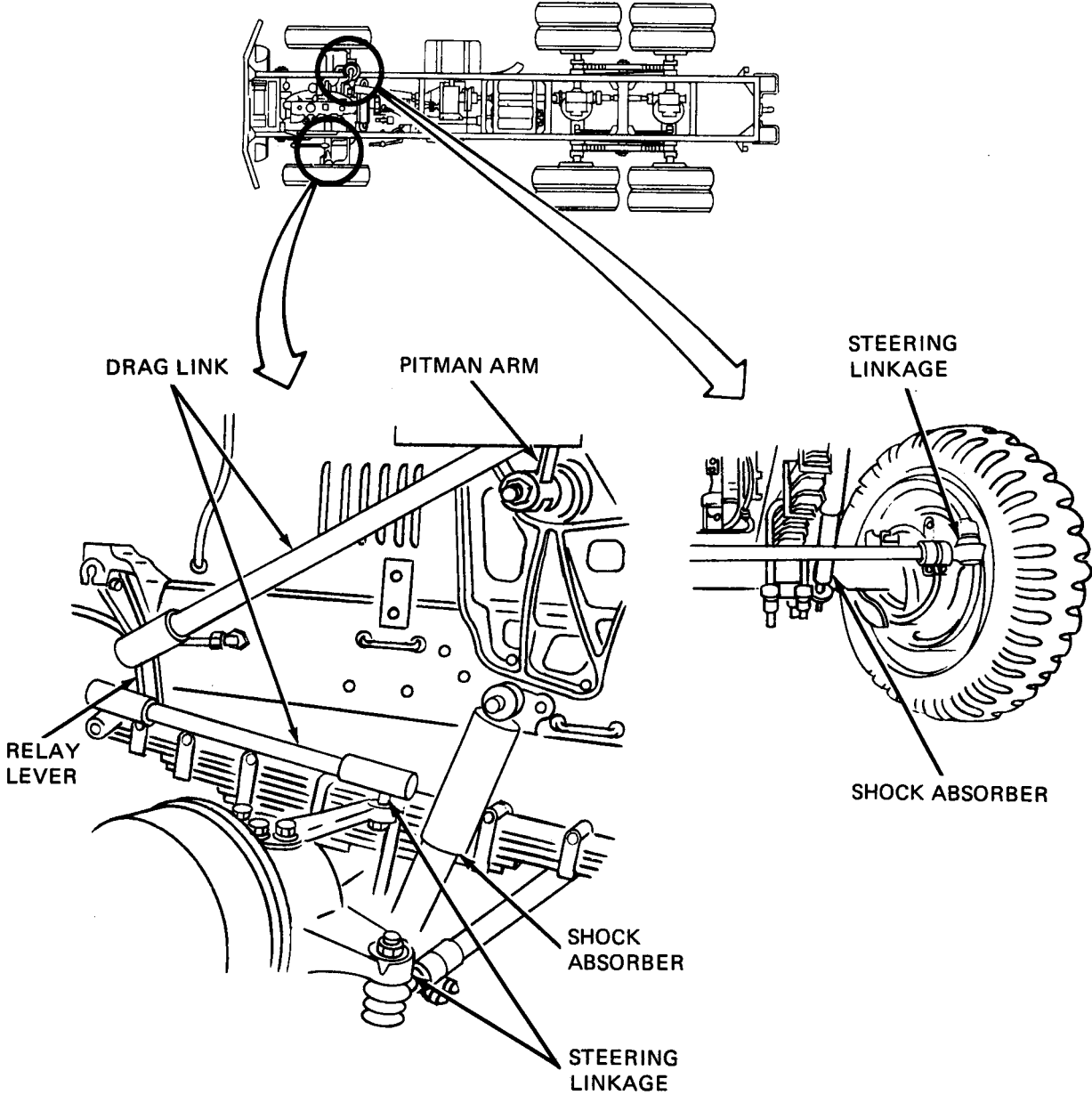

TA 116262

Figure 56-1. Steering Linkage

CHAPTER 57

STEERING SYSTEM CHECKOUT PROCEDURES

57-1. GENERAL. This chapter gives procedures for checking out the system after troubleshooting and repair have been done. Procedures are set up in flow chart form showing the checkout steps in order and referring to the fault symptom index when the system does not checkout.

STEERING SYSTEM CHECKOUT

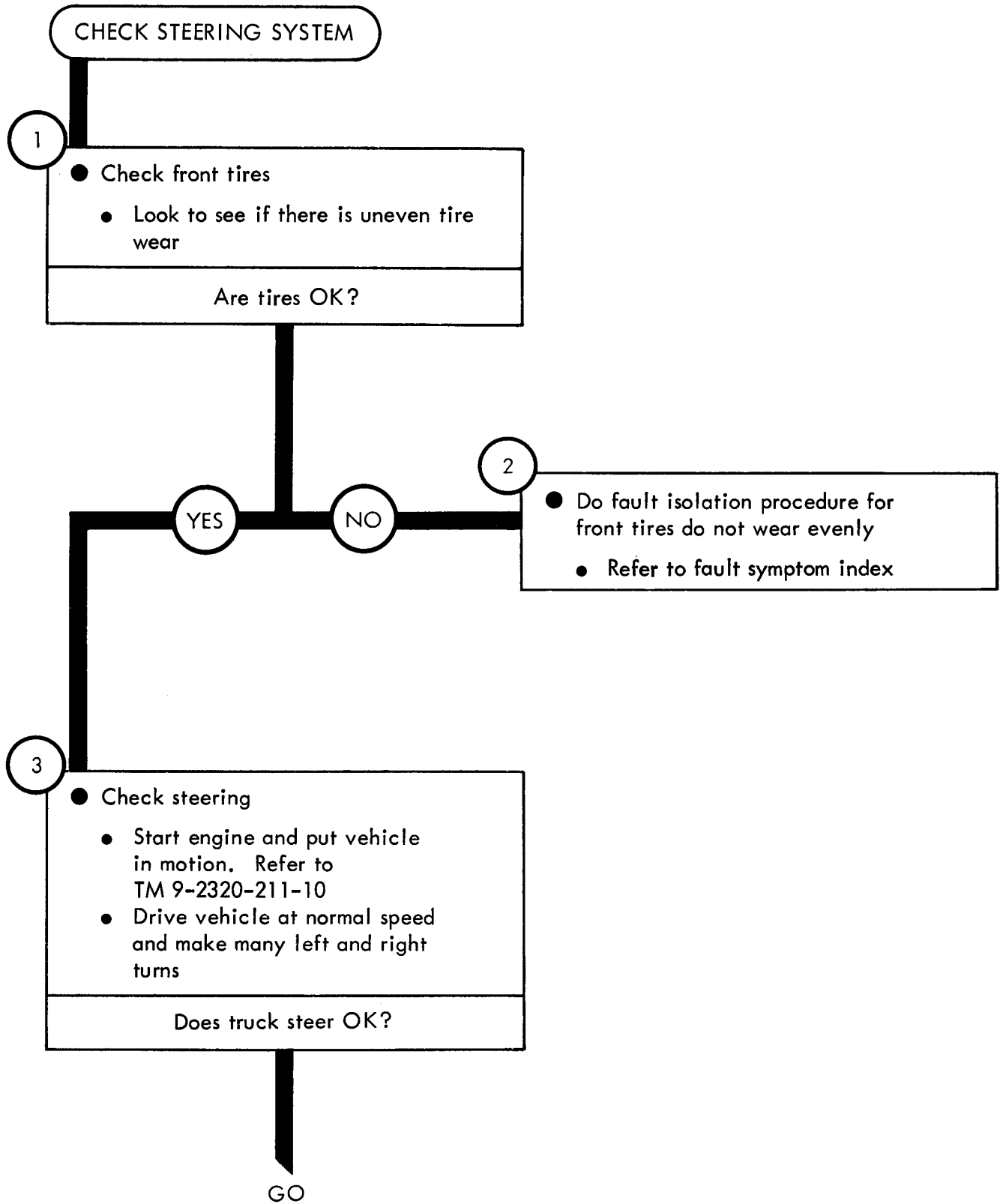

Figure 57-1 (Sheet 1 of 2)

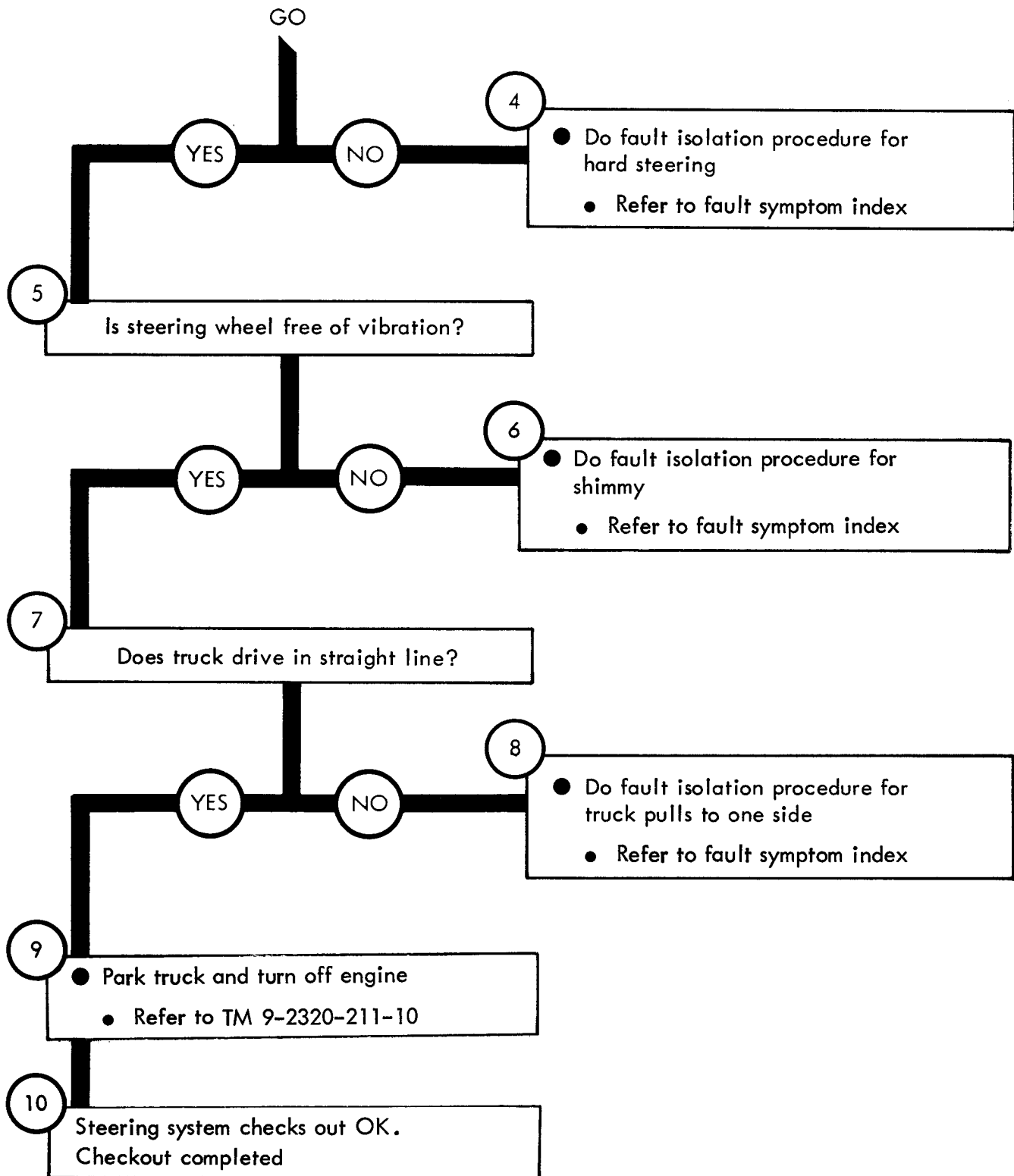

Figure 57-1 (Sheet 2 of 2)

CHAPTER 58

SPRING AND SHOCK ABSORBER SYSTEM TROUBLESHOOTING

58-1. EQUIPMENT ITEMS COVERED. This chapter gives equipment troubleshooting procedures for the spring and shock absorber system, for which there are authorized corrective maintenance tasks at the organizational maintenance level.

58-2. EQUIPMENT ITEMS NOT COVERED. All equipment items for which corrective maintenance is authorized at the organizational maintenance level are covered in this chapter.

SPRING AND SHOCK ABSORBER SYSTEM TROUBLESHOOTING

Symptom

1 FRONT TIRES DO NOT WEAR EVENLY

1

- Park truck
- Refer to TM 9-2320-211-10

2

- Check shock absorbers
 - Crawl under truck
 - Look for signs of oil leaking from shocks. See figure 56-1

Are shock absorbers OK?

YES NO 3

- Replace leaking shock absorber
 - Refer to Vol 3, chapter 16, para 16-6

NOTE

Toe-in adjustment is not part of the spring and shock group. It must be checked as a cause of the tires not wearing evenly

GO

Figure 58-1 (Sheet 1 of 2)

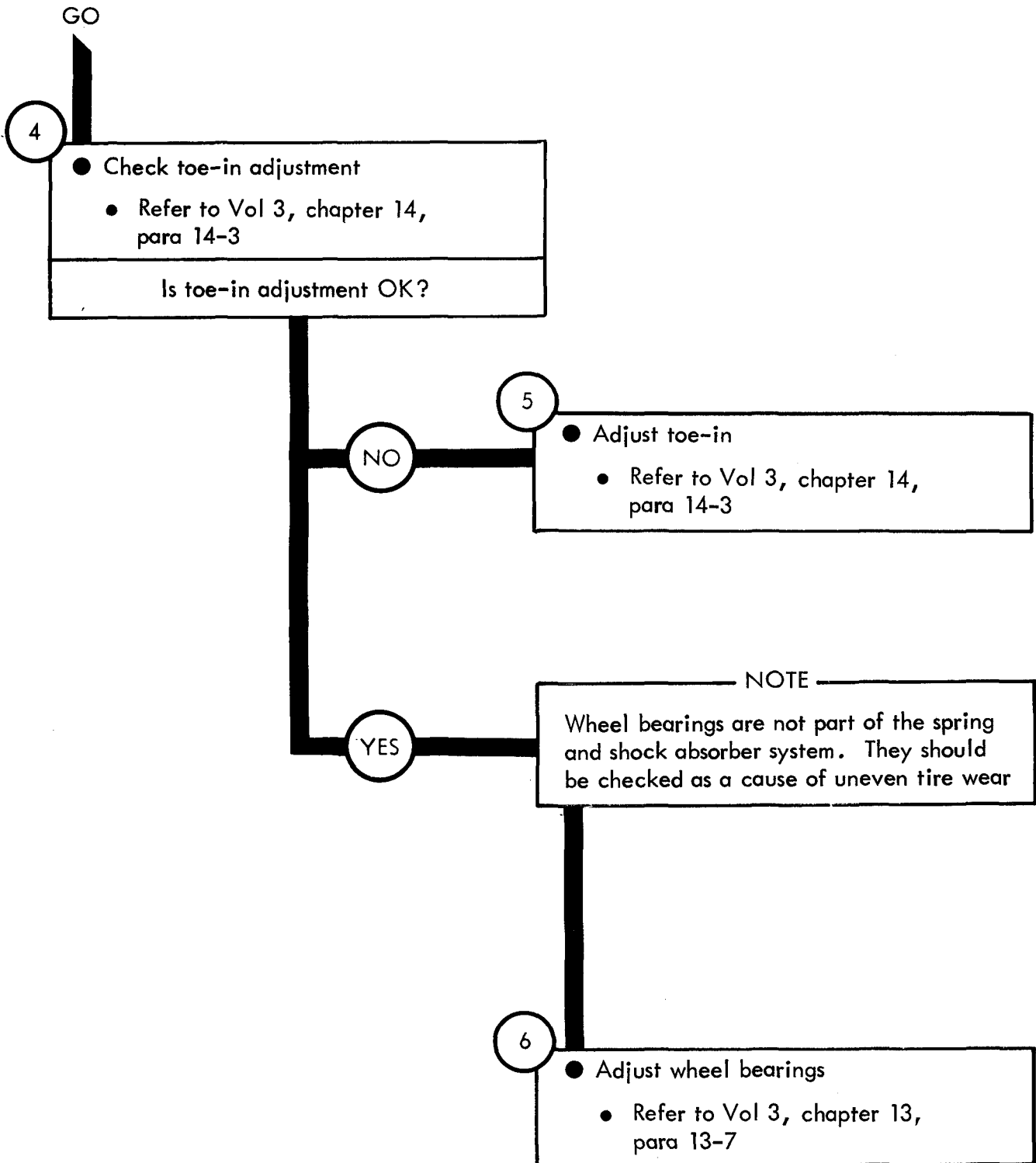

Figure 58-1 (Sheet 2 of 2)

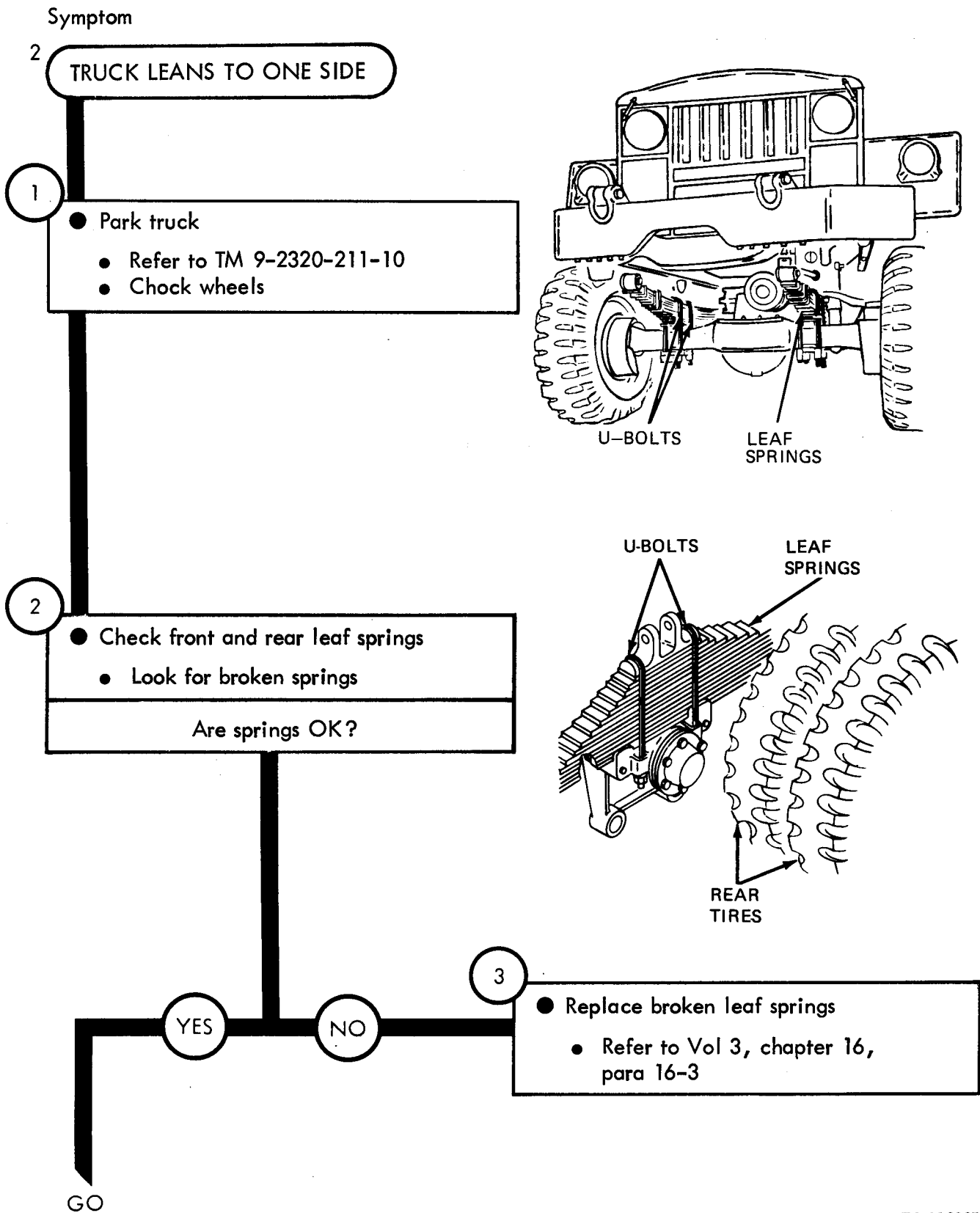

Figure 58-2 (Sheet 1 of 2)

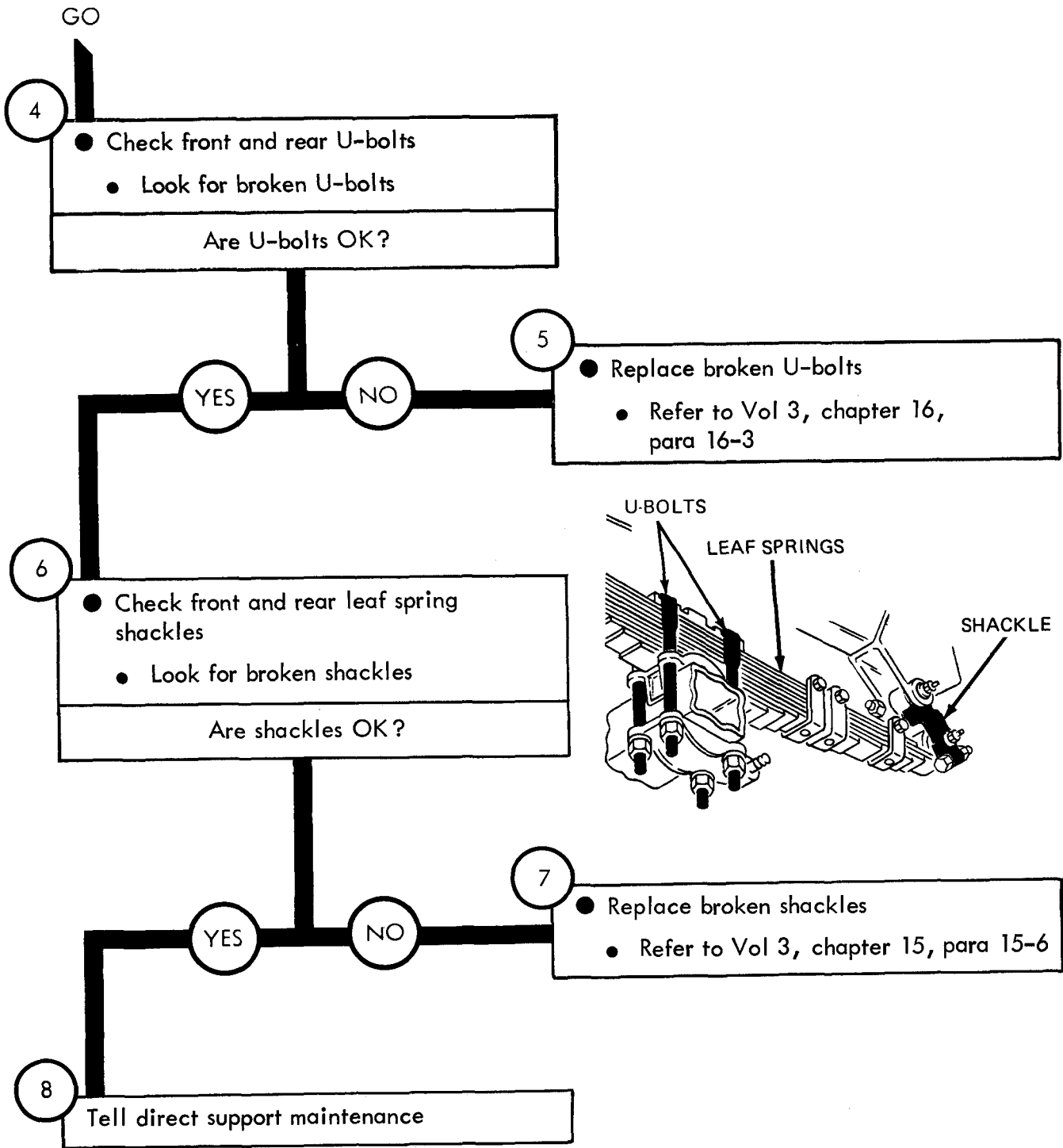

Figure 58-2 (Sheet 2 of 2)

TA 116268

CHAPTER 59

SPRING AND SHOCK ABSORBER SYSTEM TROUBLESHOOTING SUMMARY

59-1. GENERAL. This chapter gives a summary of troubleshooting procedures given in chapter 58, for the Spring and Shock Absorber System.

59-2. PROCEDURES. The summary in this chapter covers all fault symptoms found in the detailed troubleshooting procedures in Part 1. Chapter 7 outlines a sample troubleshooting procedure. The summary procedures are based on the "what-to-do" portions of the detailed procedures and do not include the "How-to-do-it" instructions. Warnings, cautions, and notes are given where needed.

SPRING AND SHOCK ABSORBER SYSTEM TROUBLESHOOTING SUMMARY

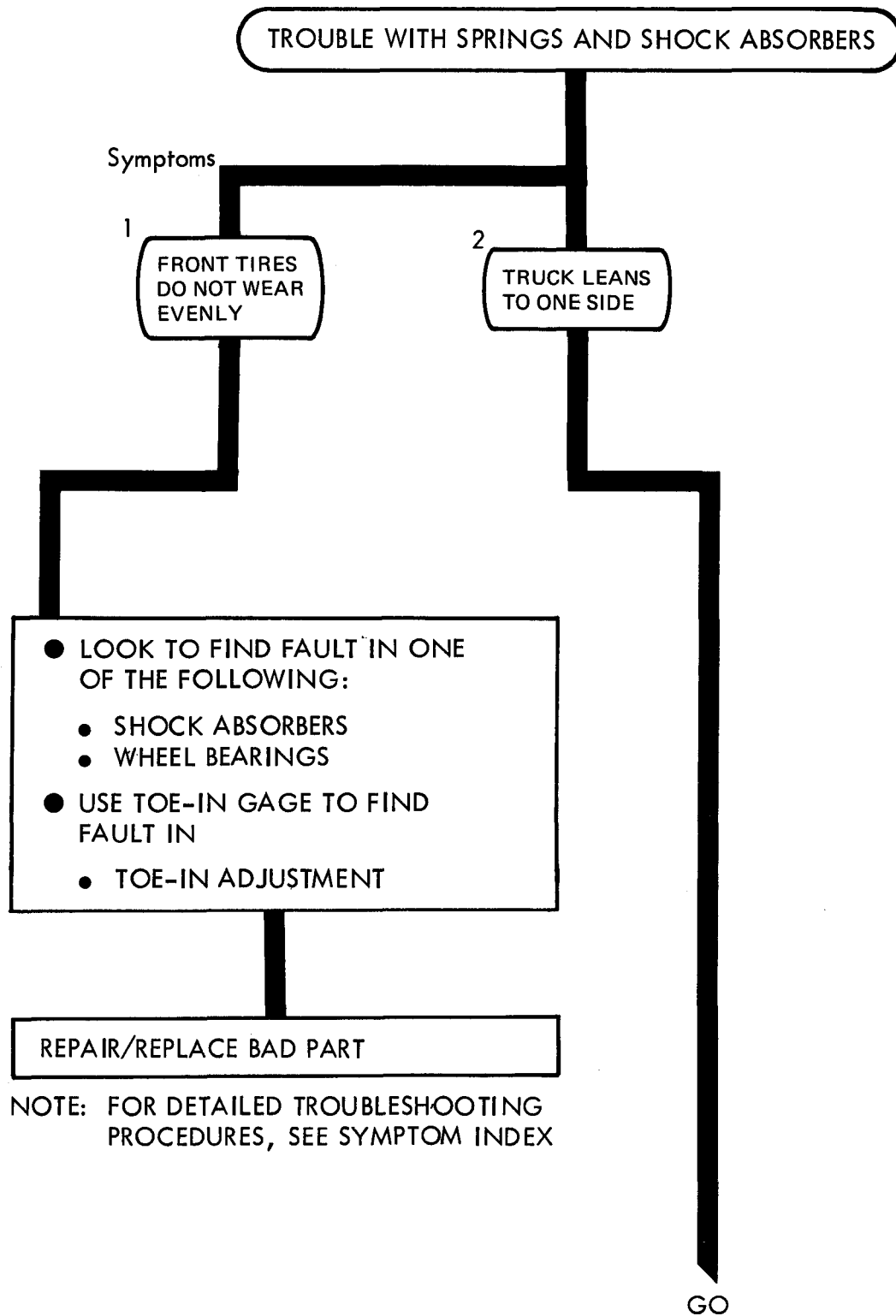
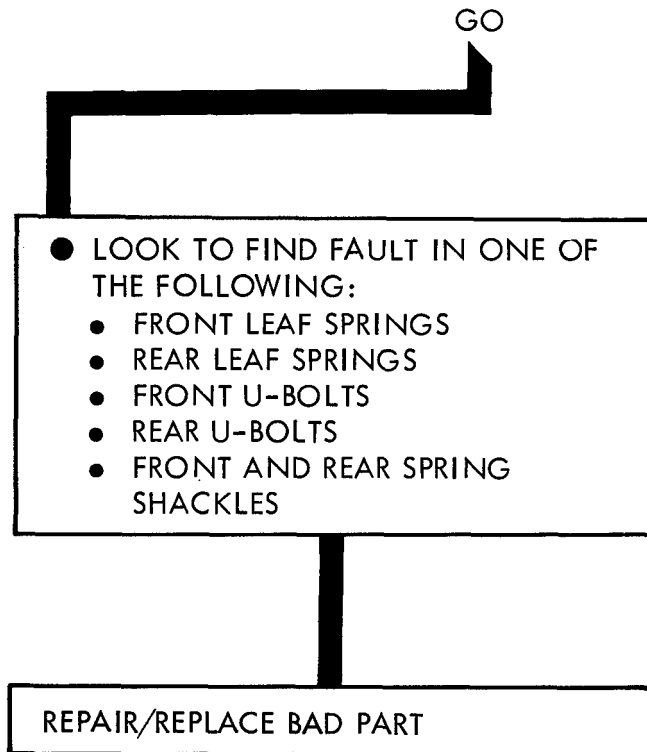

Figure 59-1 (Sheet 1 of 2)



NOTE: FOR DETAILED TROUBLESHOOTING PROCEDURES, SEE SYMPTOM INDEX

CHAPTER 60

FRONT WINCH TROUBLESHOOTING

60-1. **EQUIPMENT ITEMS COVERED.** This chapter gives equipment troubleshooting procedures for the front winch system, for which there are authorized corrective maintenance tasks at the organizational maintenance level.

60-2. **EQUIPMENT ITEMS NOT COVERED.** All equipment items for which corrective maintenance is authorized at the organizational maintenance level are covered in this chapter.

FRONT WINCH TROUBLESHOOTING

Symptom

1 WINCH DOES NOT PULL LOAD

- 1
- Make truck ready for work on front winch
 - Turn off winch. Refer to TM 9-2320-211-10
 - Turn off engine. Refer to TM 9-2320-211-10
 - Chock wheels

- 2
- Check universal joint and shear pin
 - Look for broken universal joint on power takeoff to winch propeller shaft. See figure 39-1 or 39-2
 - Look for a broken shear pin on power divider to rear winch propeller shaft
- Are universal joint and shear pin OK?

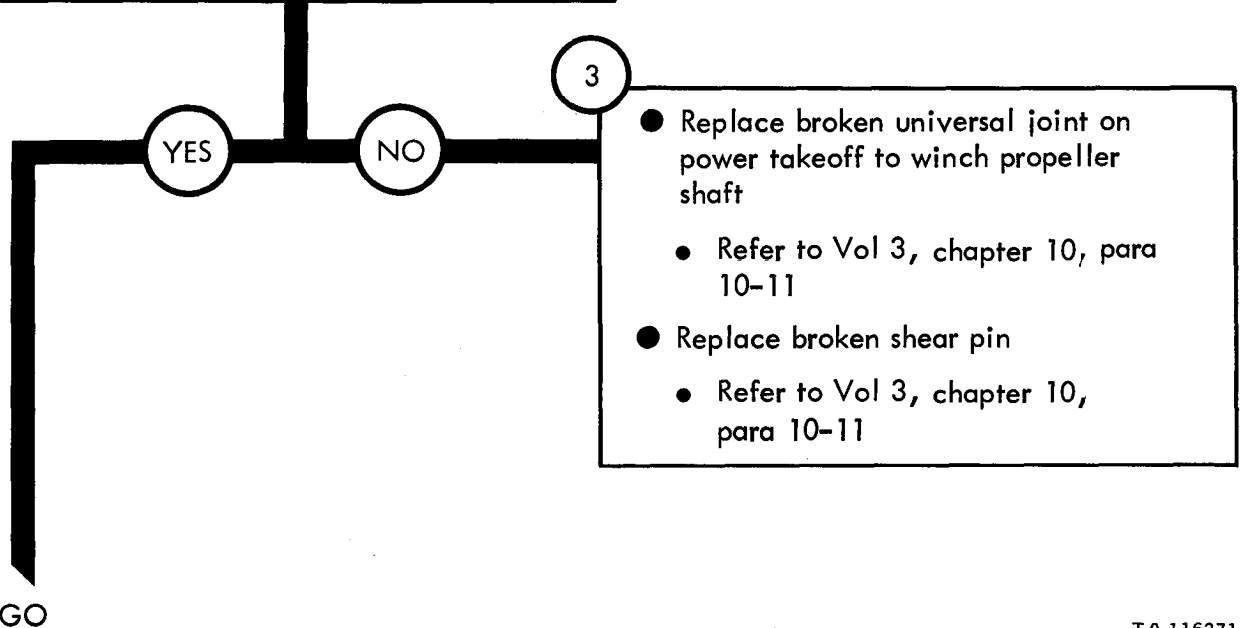
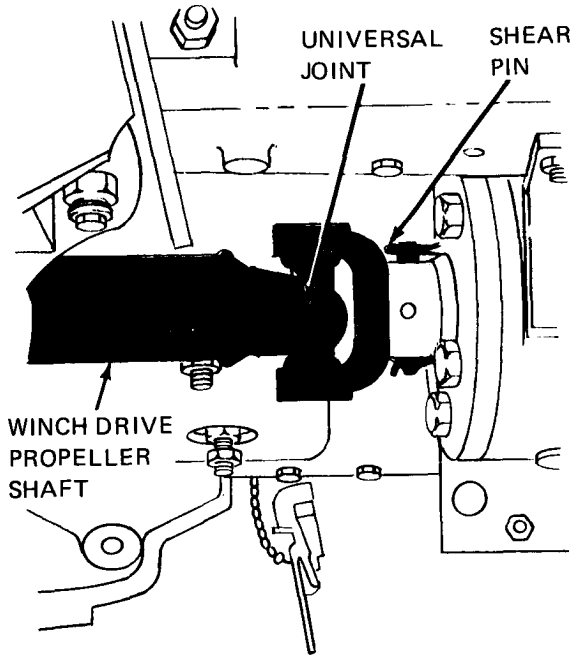

Figure 60-1 (Sheet 1 of 3)

TA 116271

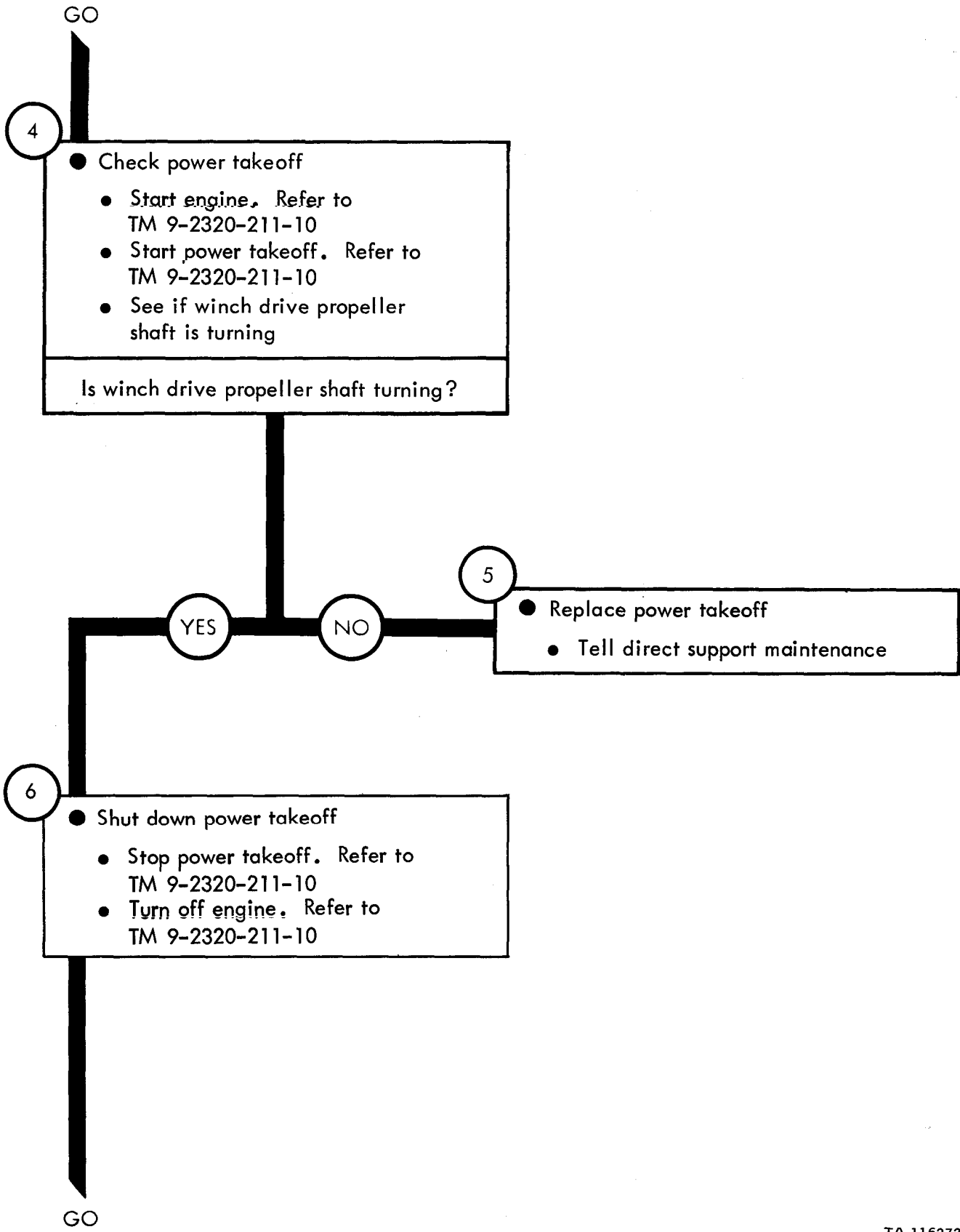

Figure 60-1 (Sheet 2 of 3)

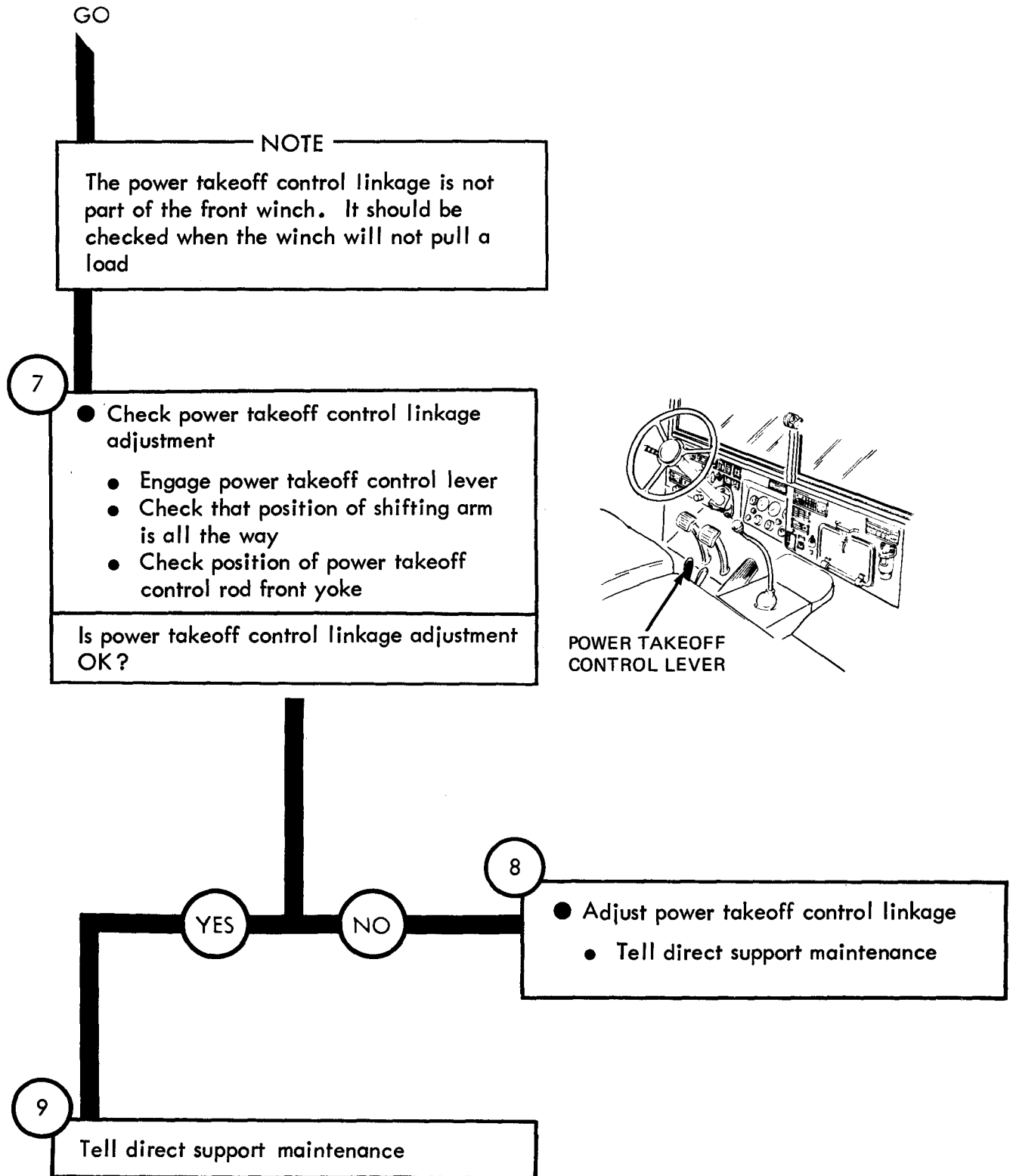

Figure 60-1 (Sheet 3 of 3)

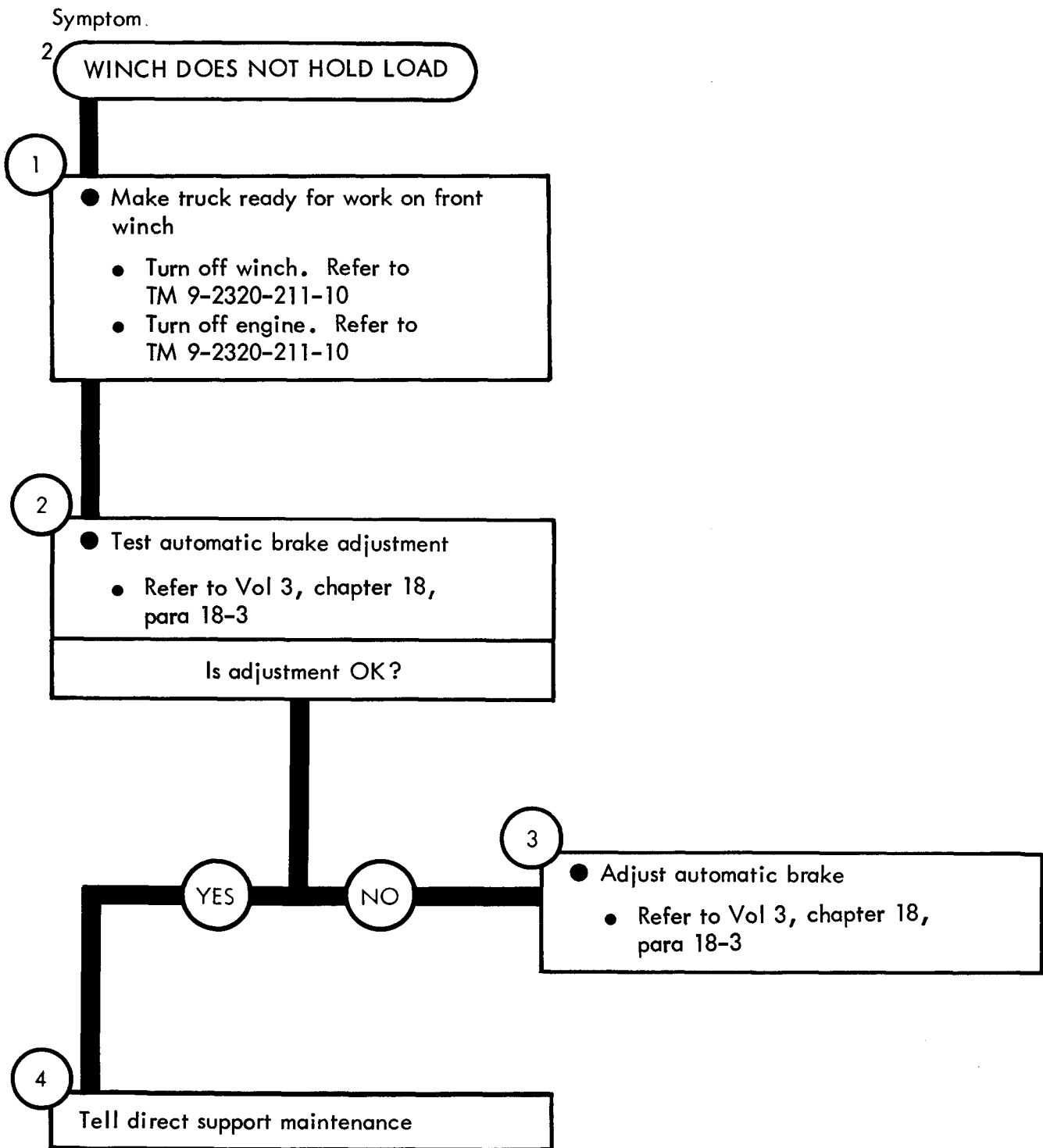

Figure 60-2

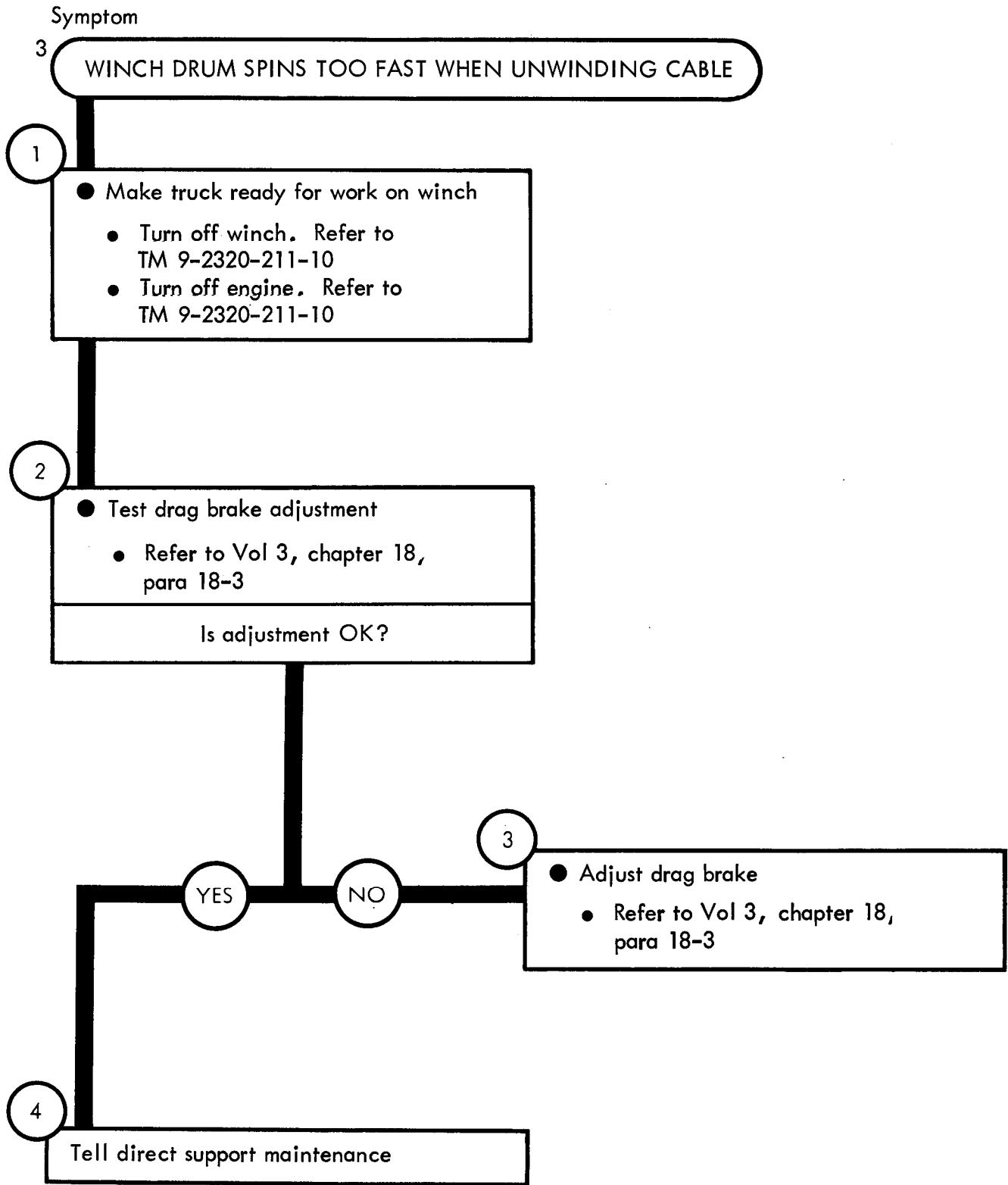

Figure 60-3

CHAPTER 61

FRONT WINCH TROUBLESHOOTING SUMMARY

61-1. GENERAL. This chapter gives a summary of troubleshooting procedures given in chapter 60, for the Front Winch System.

61-2. PROCEDURES. The summary in this chapter covers all fault symptoms found in the detailed troubleshooting procedures in Part 1. Chapter 7 outlines a sample troubleshooting procedure. The summary procedures are based on the "what-to-do" portions of the detailed procedures and do not include the "How-to-do-it" instructions. Warnings, cautions, and notes are given where needed.

FRONT WINCH TROUBLESHOOTING SUMMARY

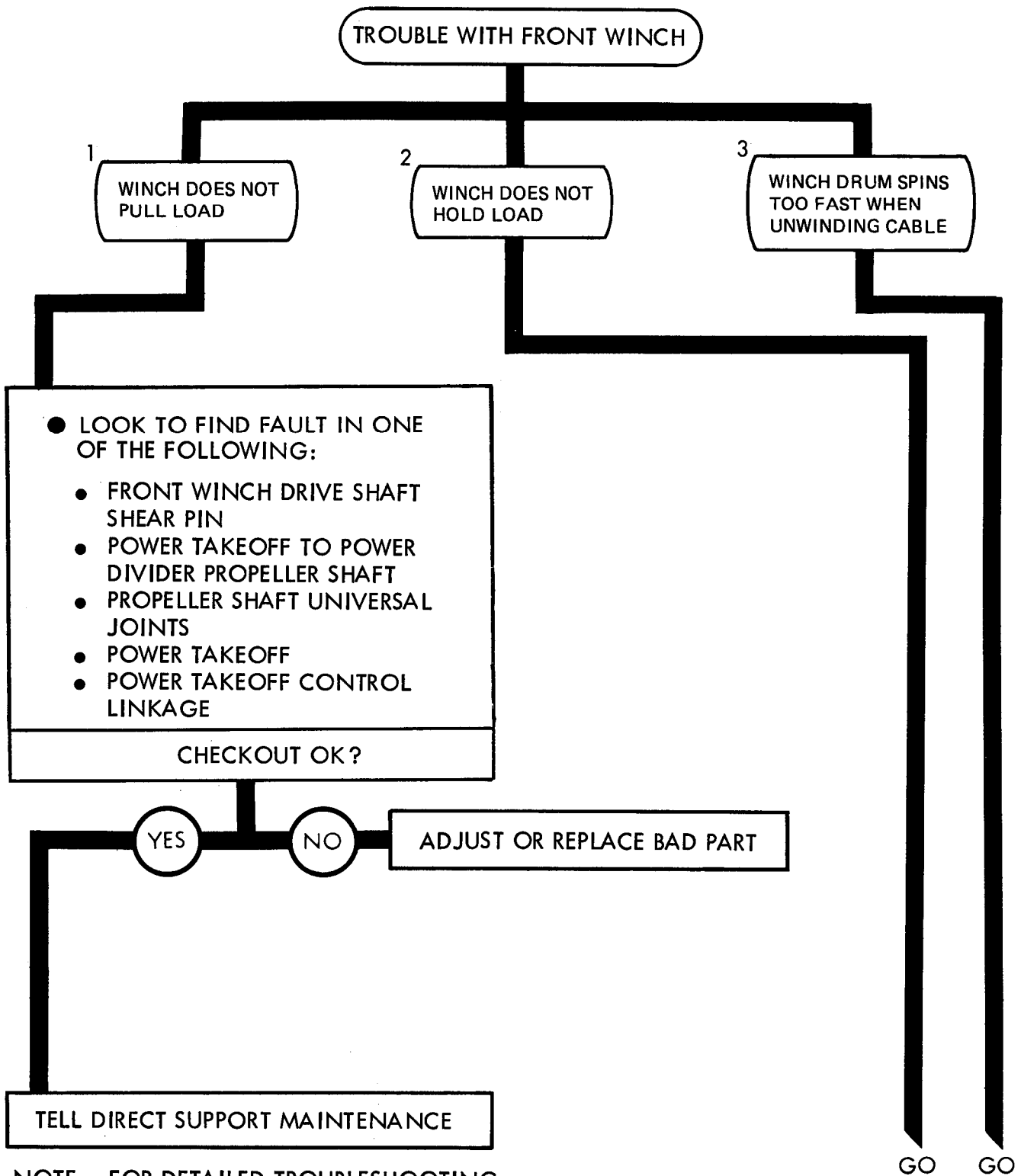

NOTE: FOR DETAILED TROUBLESHOOTING PROCEDURES, SEE SYMPTOM INDEX

TA 116276

Figure 61-1 (Sheet 1 of 3)

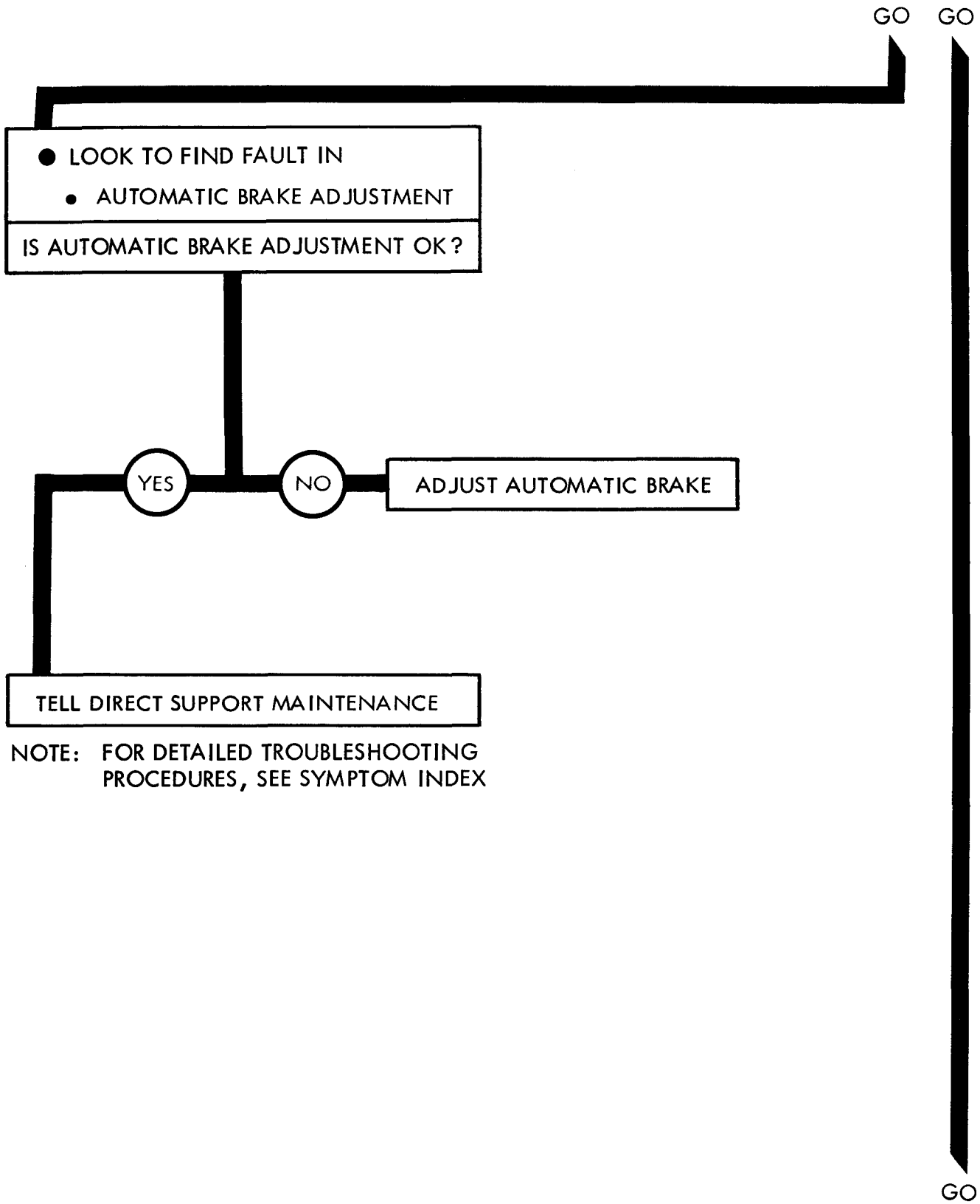

NOTE: FOR DETAILED TROUBLESHOOTING PROCEDURES, SEE SYMPTOM INDEX

Figure 61-1 (Sheet 2 of 3)

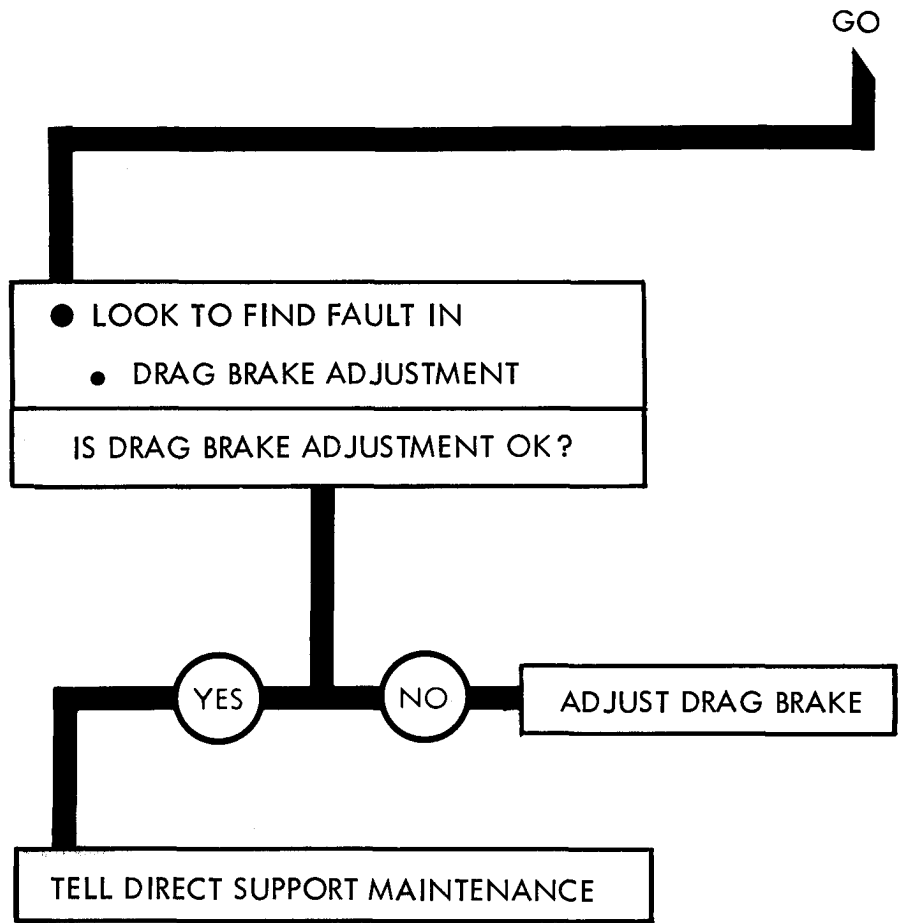

NOTE: FOR DETAILED TROUBLESHOOTING PROCEDURES, SEE SYMPTOM INDEX

Figure 61-1 (Sheet 3 of 3)

CHAPTER 62

FRONT WINCH CHECKOUT PROCEDURES

62-1. GENERAL. This chapter gives procedures for checking out the system after troubleshooting and repair have been done. Procedures are set up in flow chart form showing the checkout steps in order and referring to the fault symptom index when the system does not checkout.

Symptom

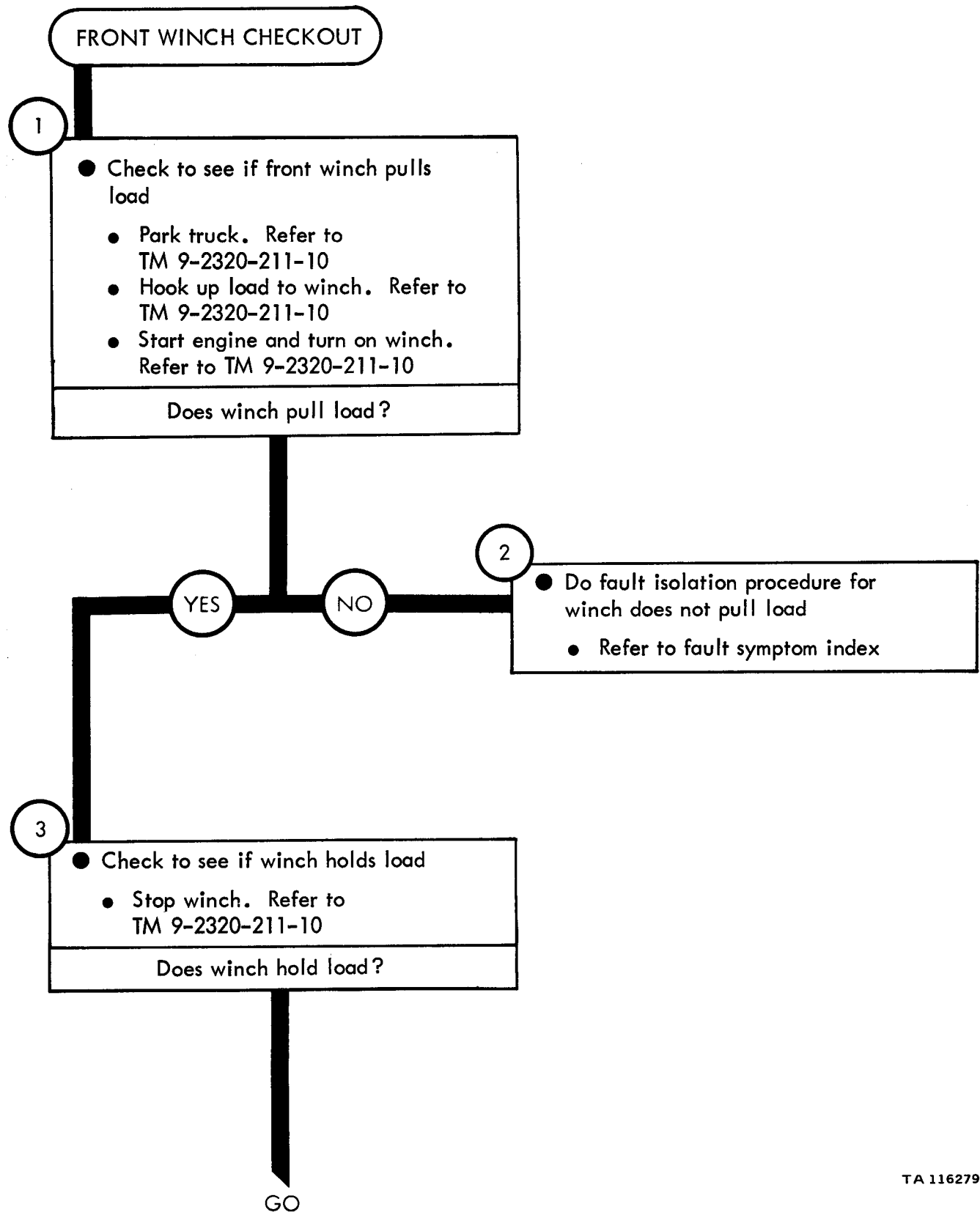

Figure 62-1 (Sheet 1 of 2)

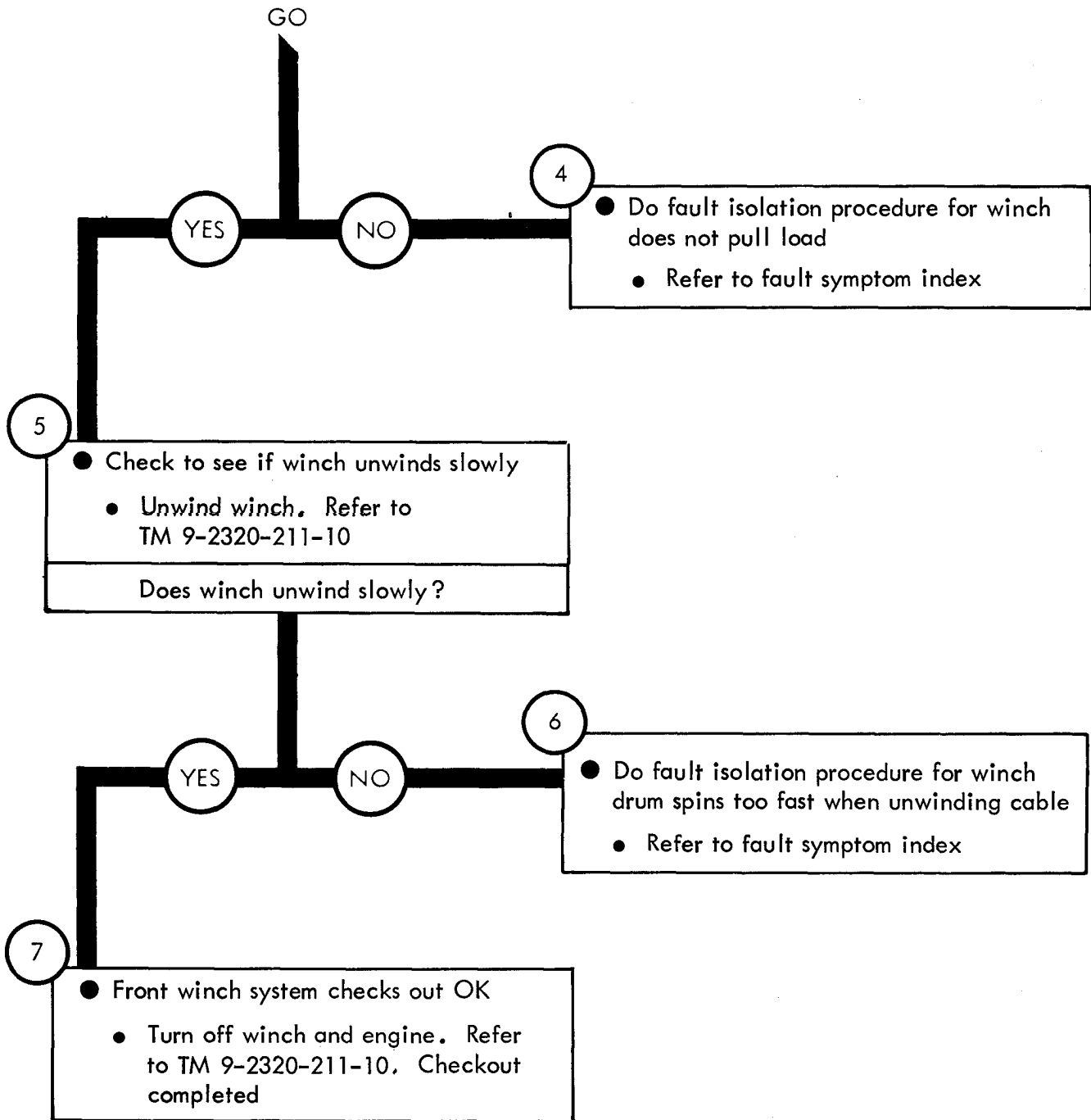

Figure 62-1 (Sheet 2 of 2)

CHAPTER 63

DUMP BODY AND HOIST SYSTEM TROUBLESHOOTING

63-1. EQUIPMENT ITEMS COVERED. This chapter gives equipment troubleshooting procedures for the dump body and hoist system, for which there are authorized corrective maintenance tasks at the organizational maintenance level.

63-2. EQUIPMENT ITEMS NOT COVERED. All equipment items for which corrective maintenance is authorized at the organizational maintenance level are covered in this chapter.

DUMP BODY AND HOIST SYSTEM TROUBLESHOOTING

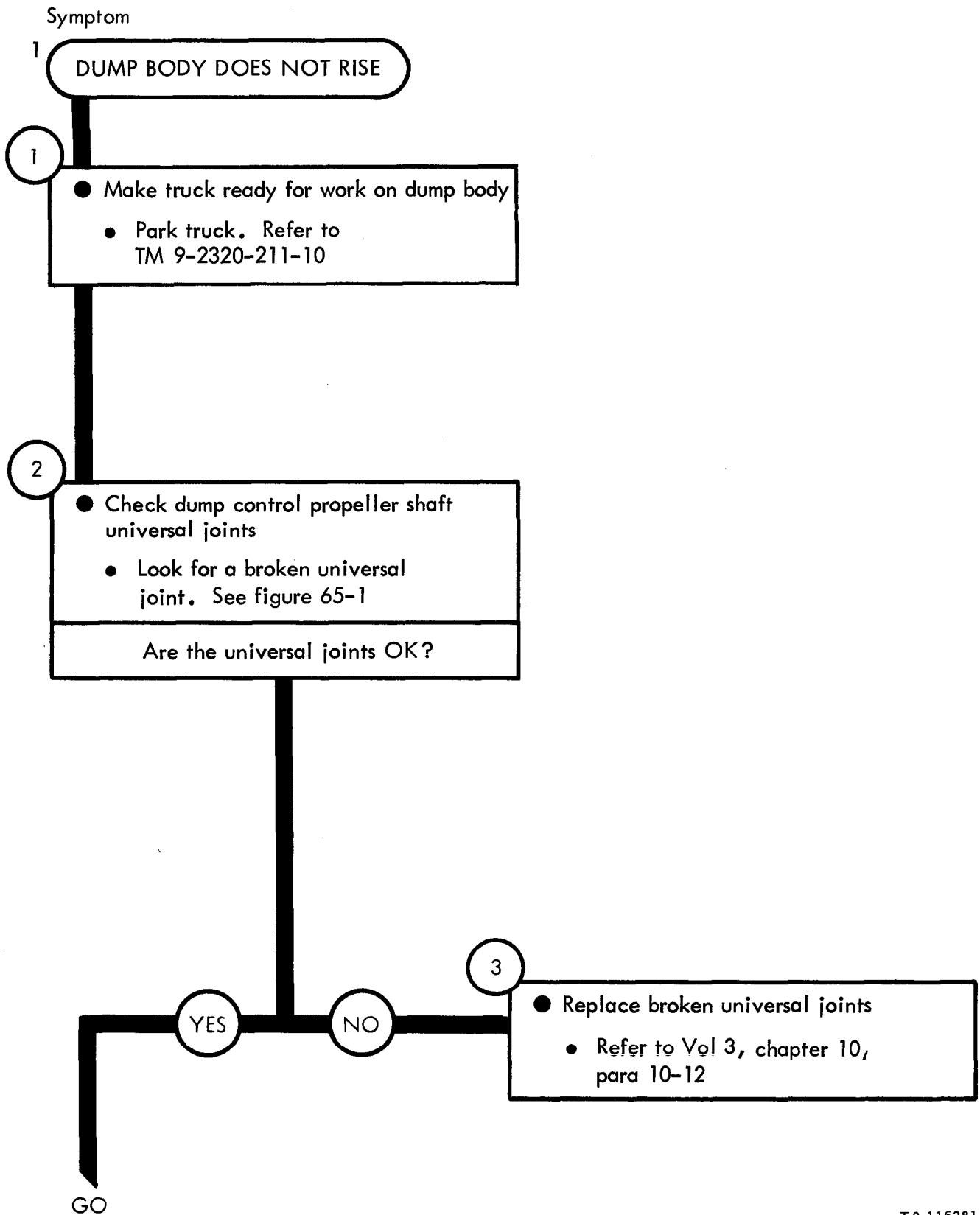

Figure 63-1 (Sheet 1 of 4)

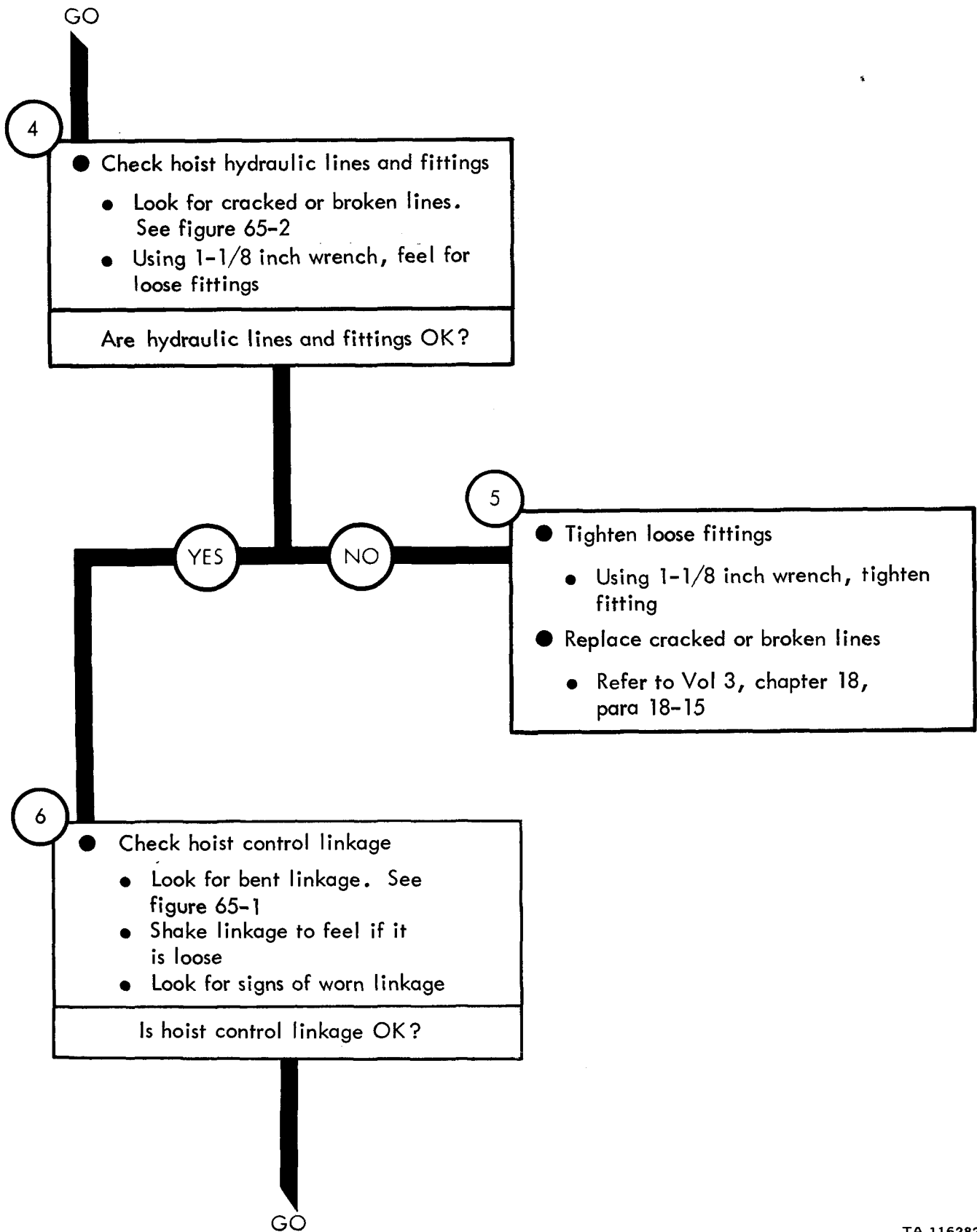

Figure 63-1 (Sheet 2 of 4)

TA 116282

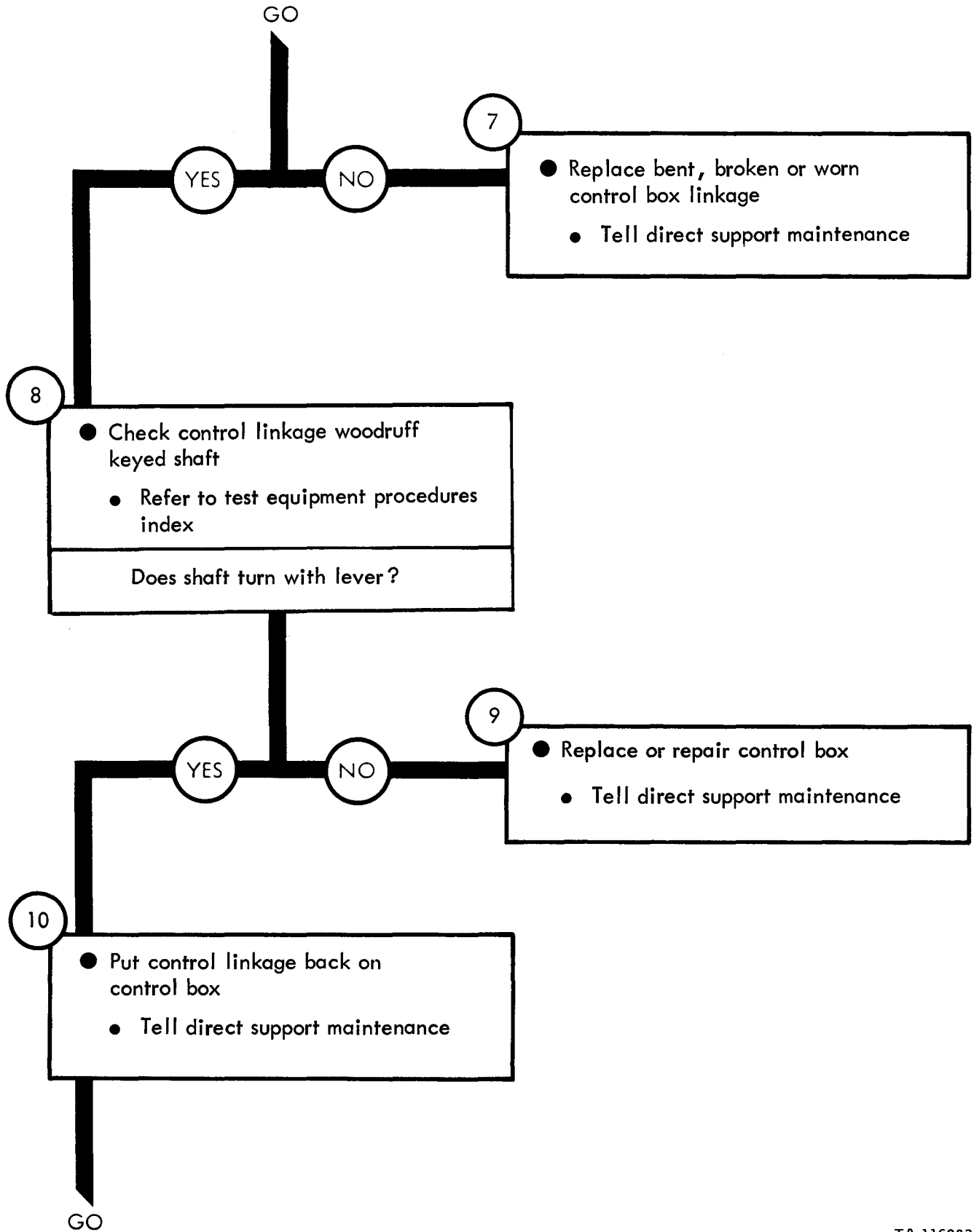

Figure 63-1 (Sheet 3 of 4)

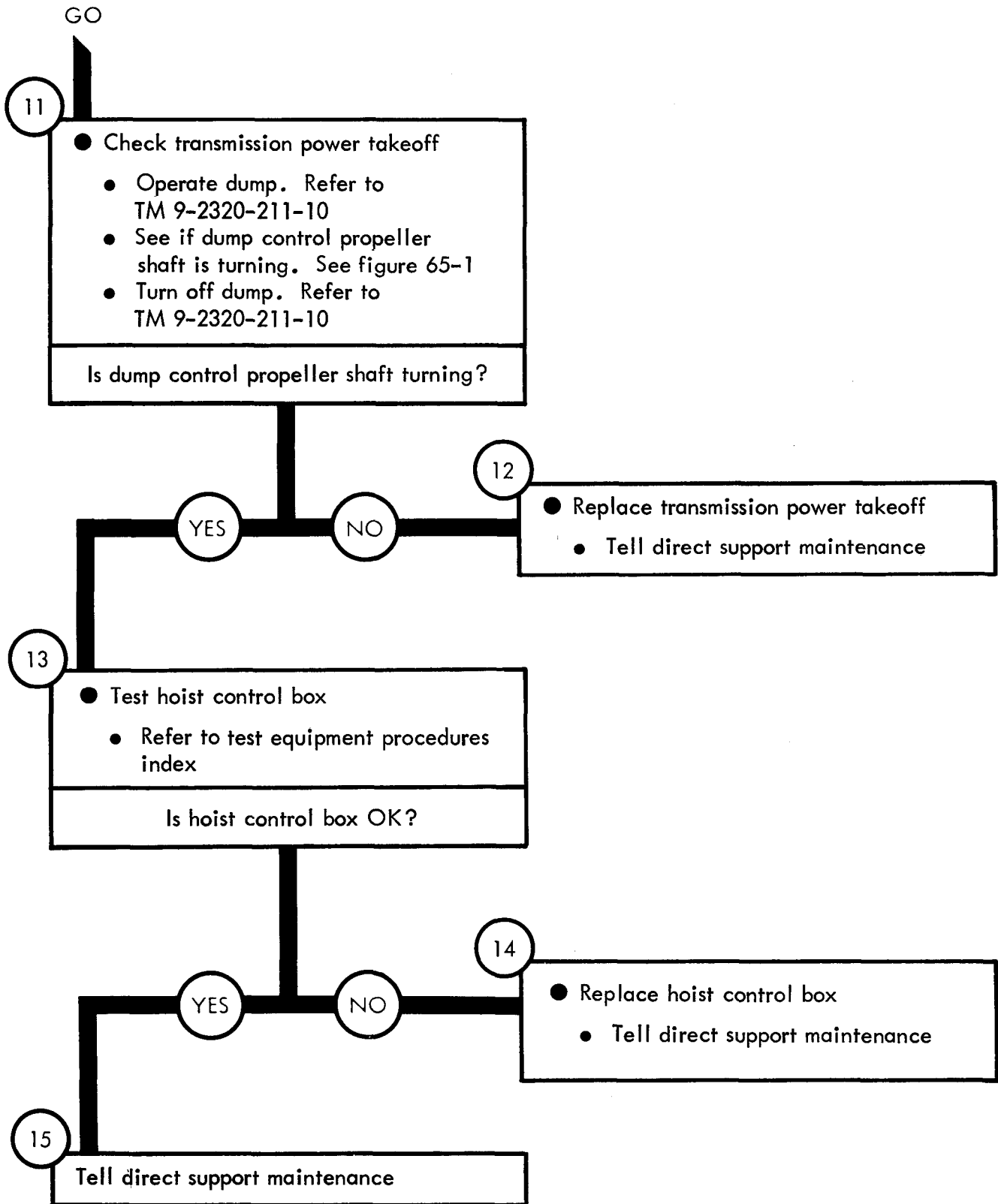

Figure 63-1 (Sheet 4 of 4)

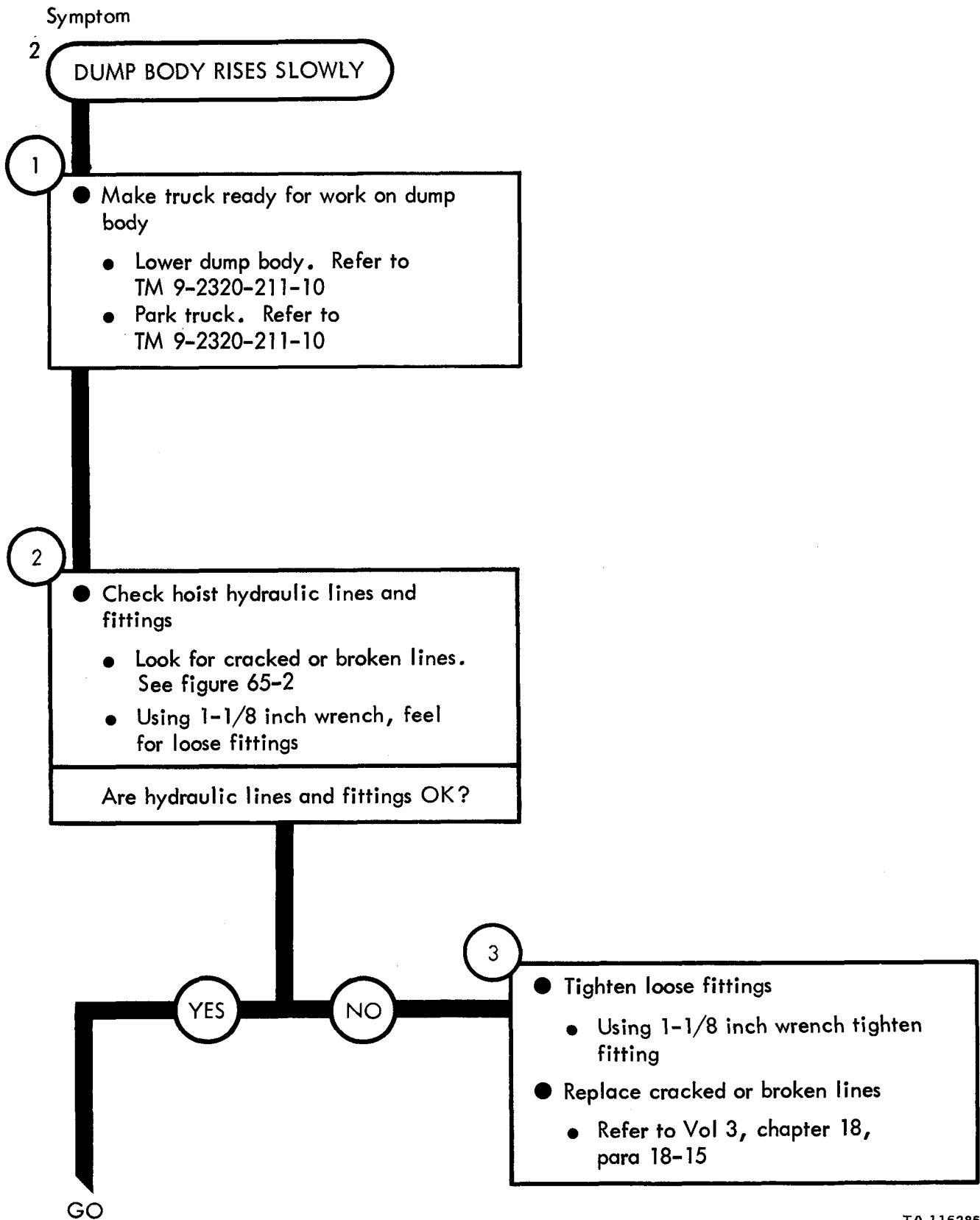

Figure 63-2 (Sheet 1 of 4)

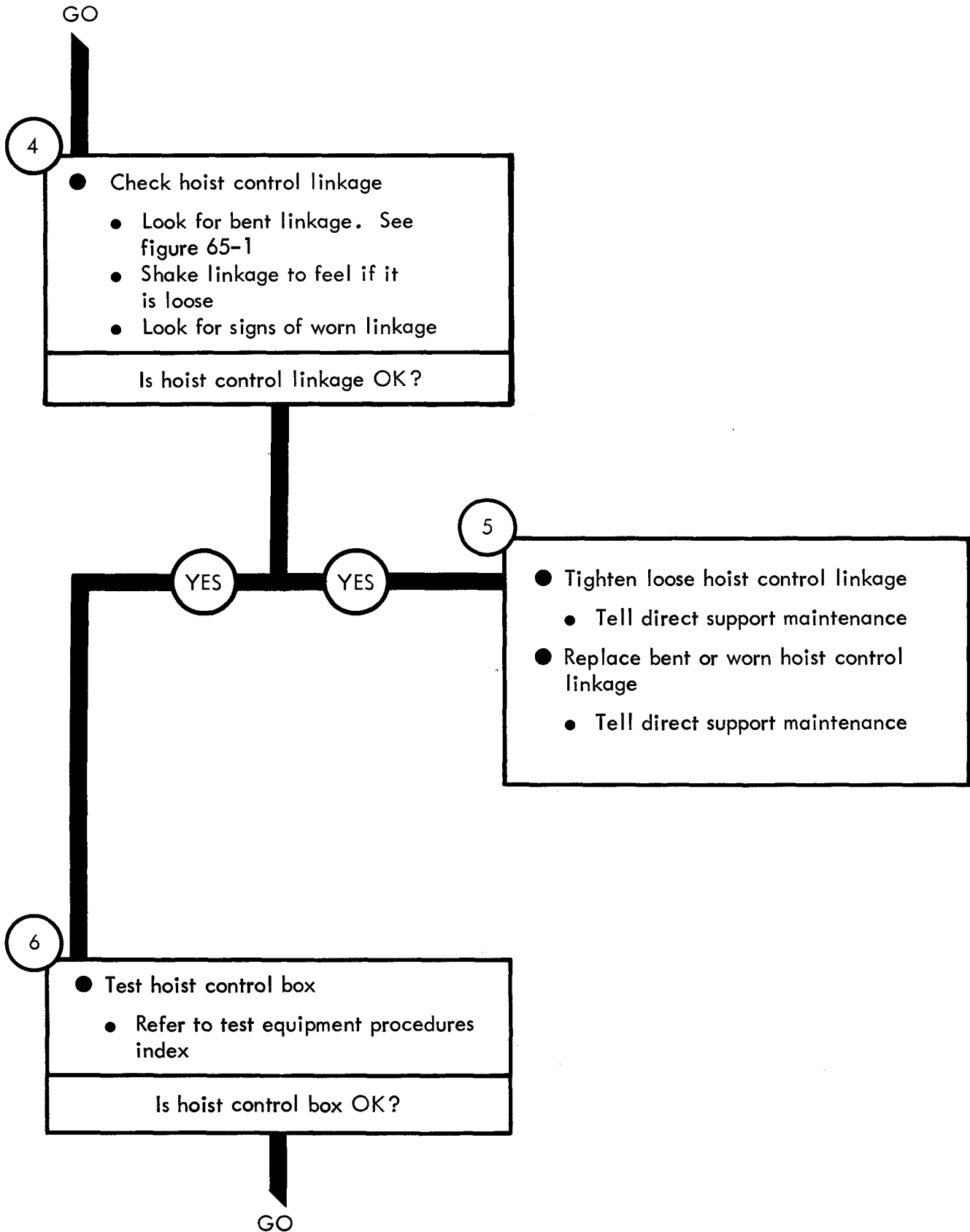

Figure 63-2 (Sheet 2 of 4)

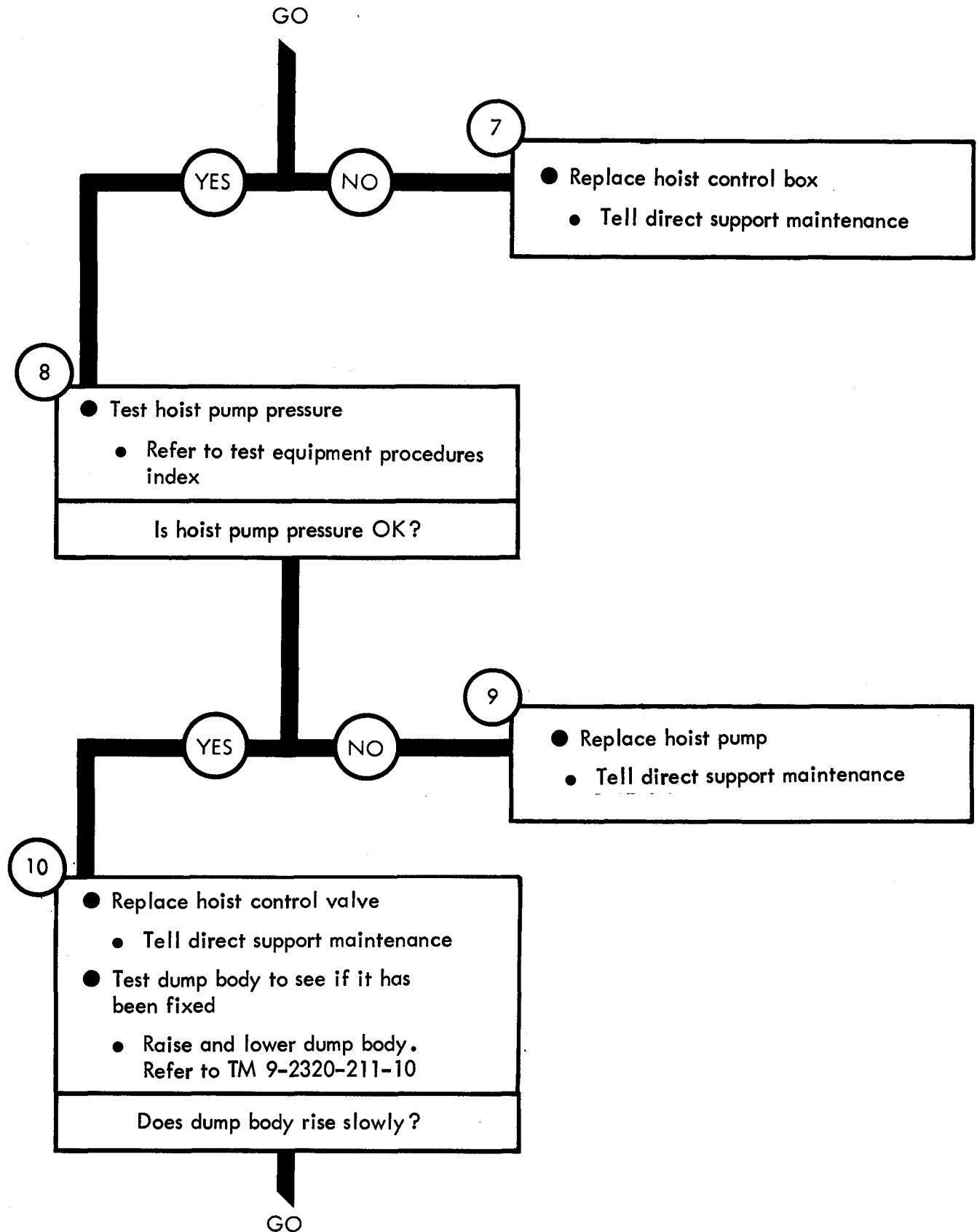

Figure 63-2 (Sheet 3 of 4)

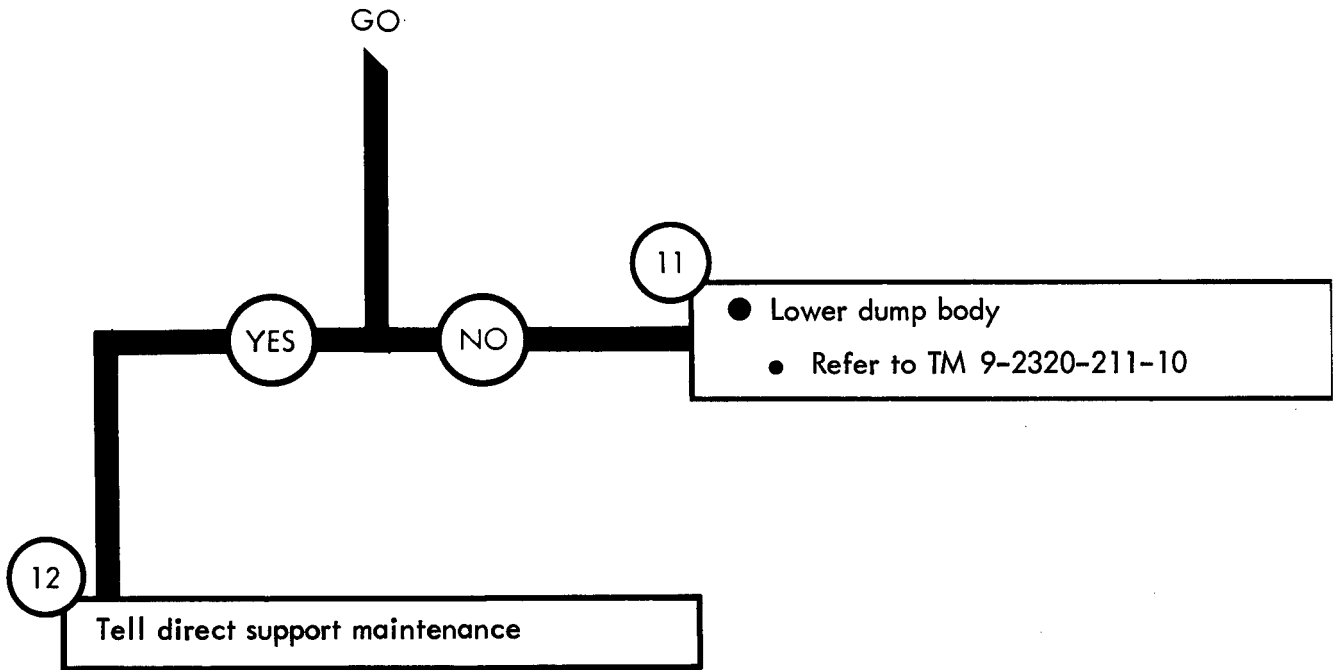
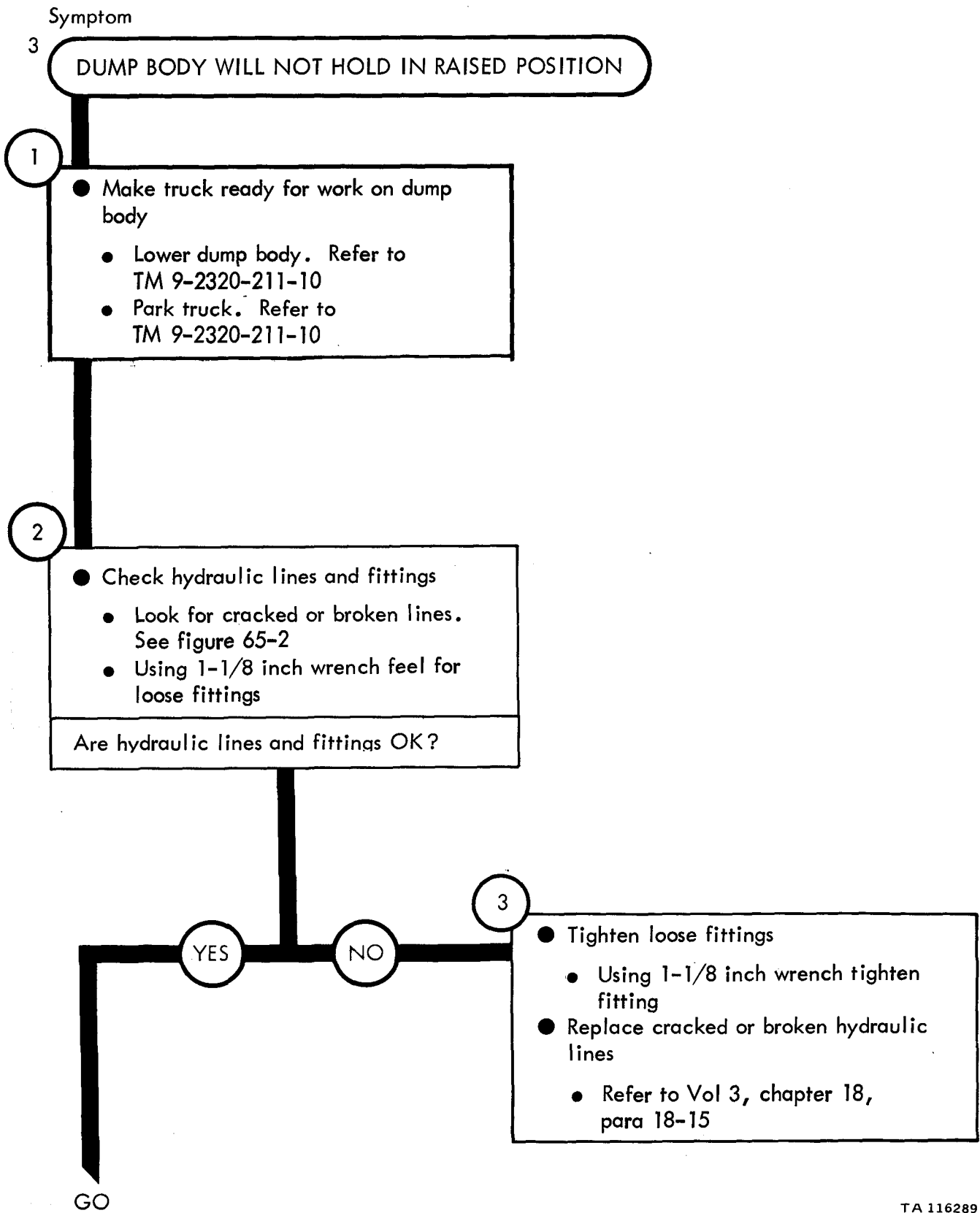

Figure 63-2 (Sheet 4 of 4)



TA 116289

Figure 63-3 (Sheet 1 of 2)

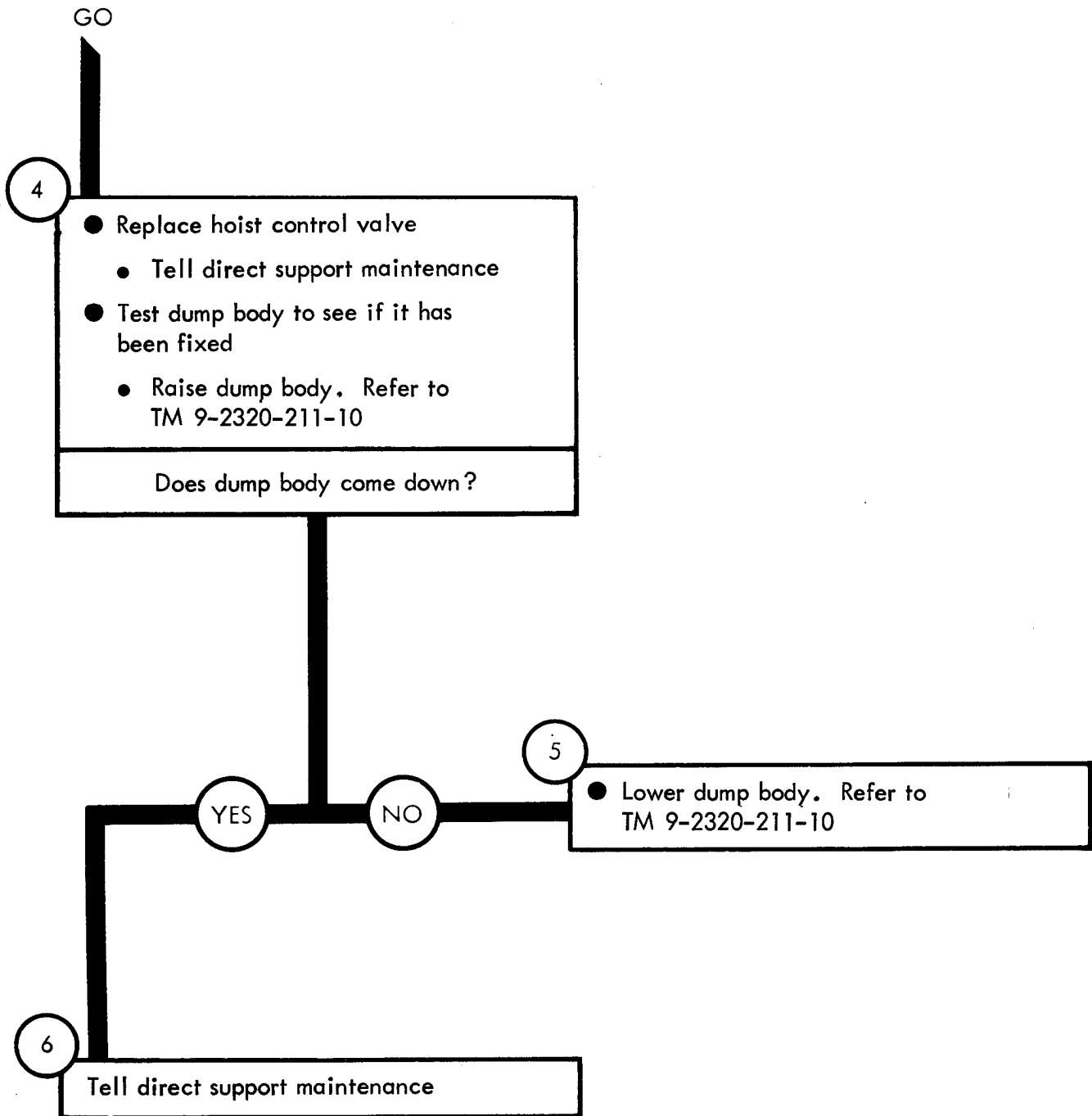

Figure 63-3 (Sheet 2 of 2)

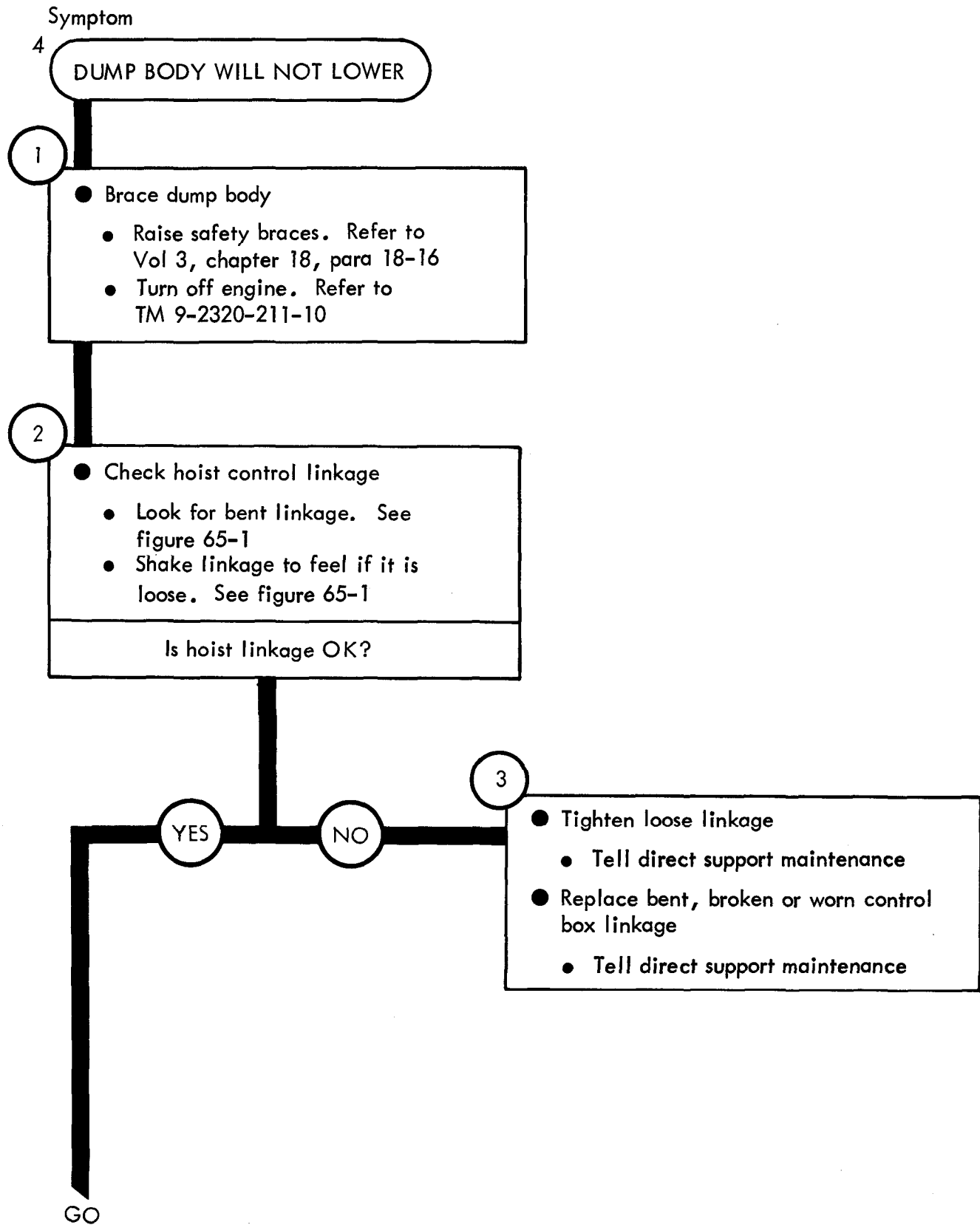
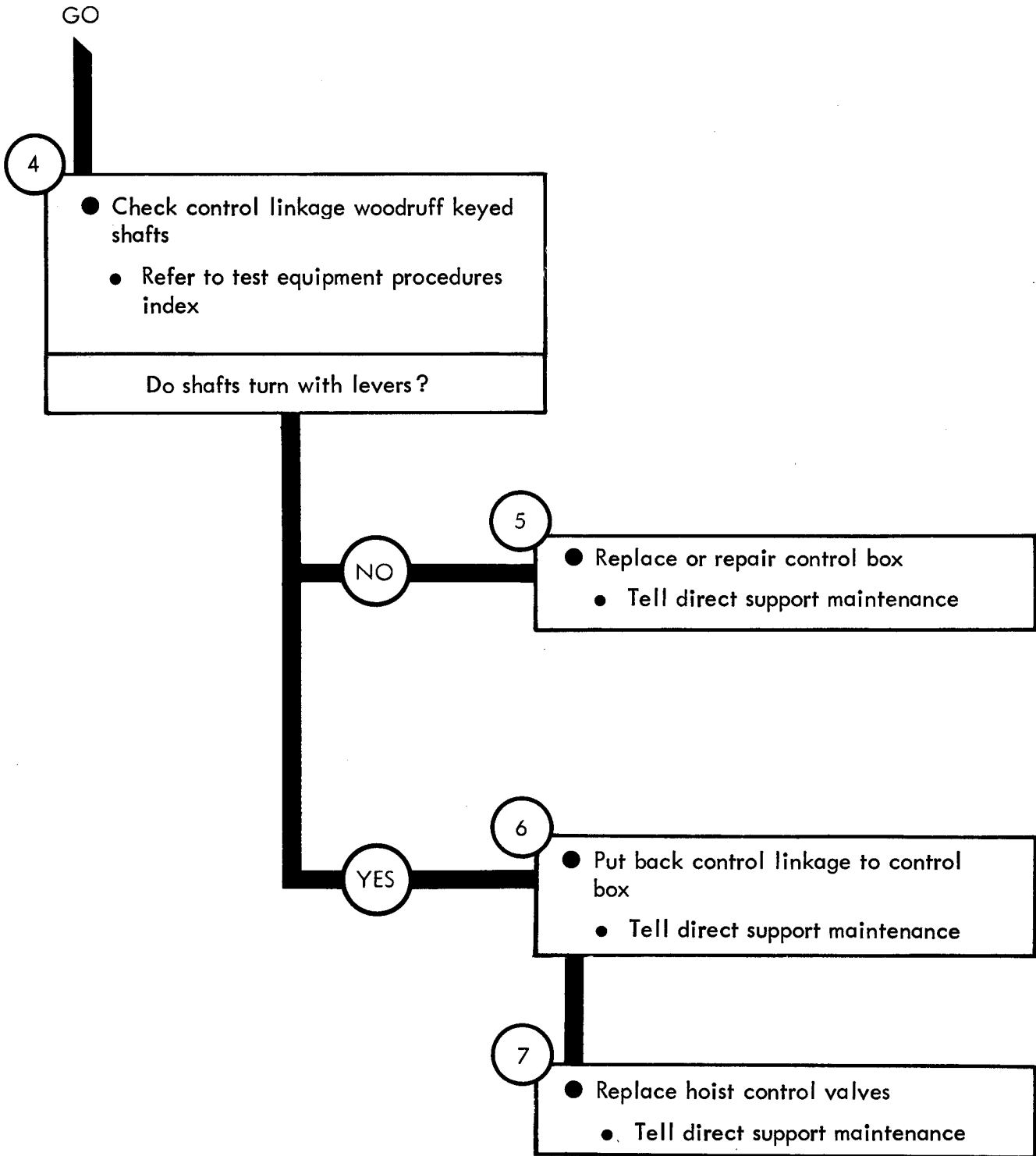

Figure 63-4 (Sheet 1 of 2)



TA 116292

Figure 63-4 (Sheet 2 of 2)

CHAPTER 64

DUMP BODY AND HOIST SYSTEM TROUBLESHOOTING SUMMARY

64-1. GENERAL. This chapter gives a summary of troubleshooting procedures given in chapter 63, for the Dump and Hoist System.

64-2. PROCEDURES . The summary in this chapter covers all fault symptoms found in the detailed troubleshooting procedures in Part 1. Chapter 7 outlines a sample troubleshooting procedure. The summary procedures are based on the "what-to-do" portions of the detailed procedures and do not include the "How-to-do-it" instructions. Warnings, cautions, and notes are given where needed.

DUMP BODY AND HOIST SYSTEM TROUBLESHOOTING SUMMARY

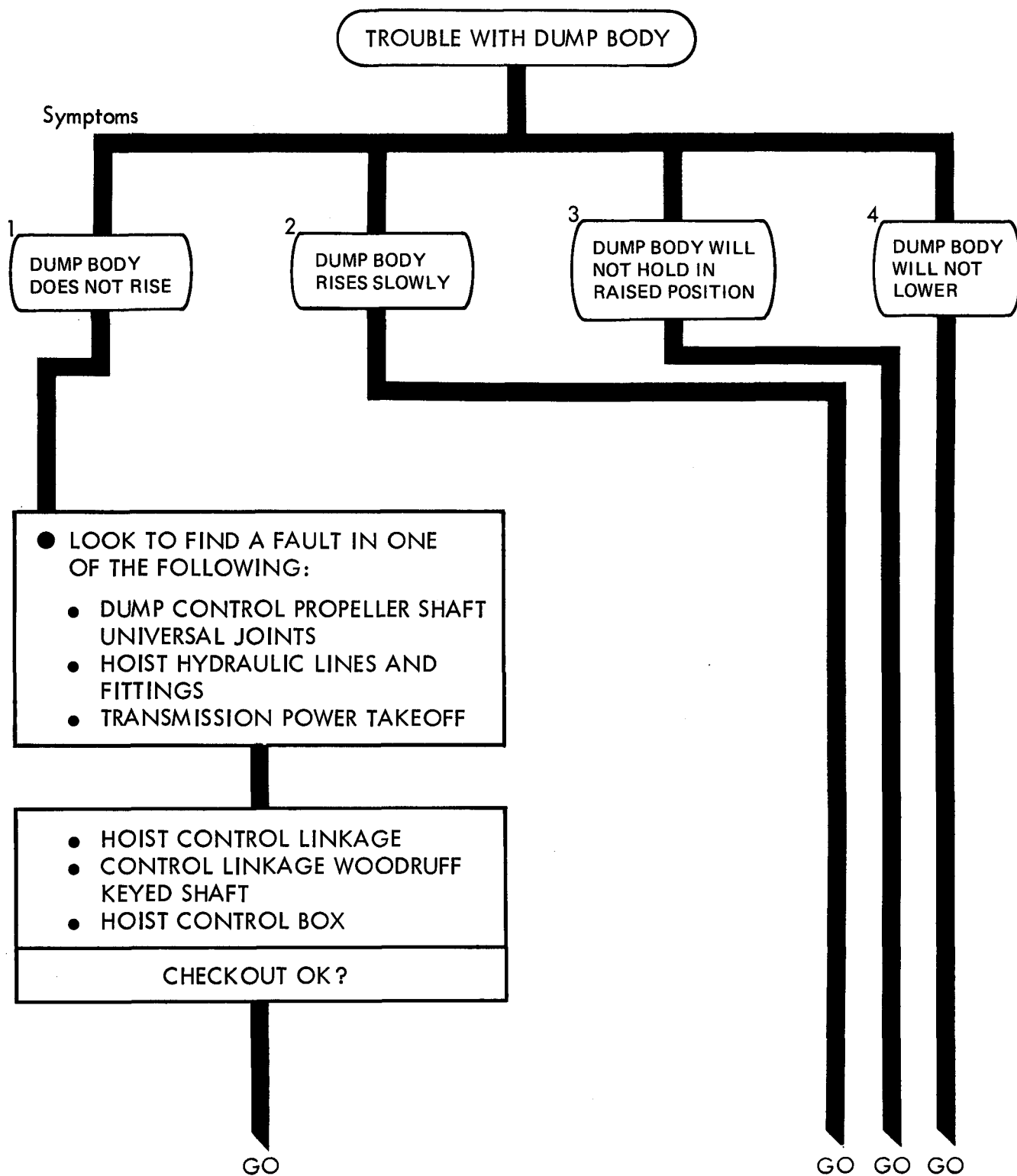

Figure 64-1 (Sheet 1 of 4)

TA 116294

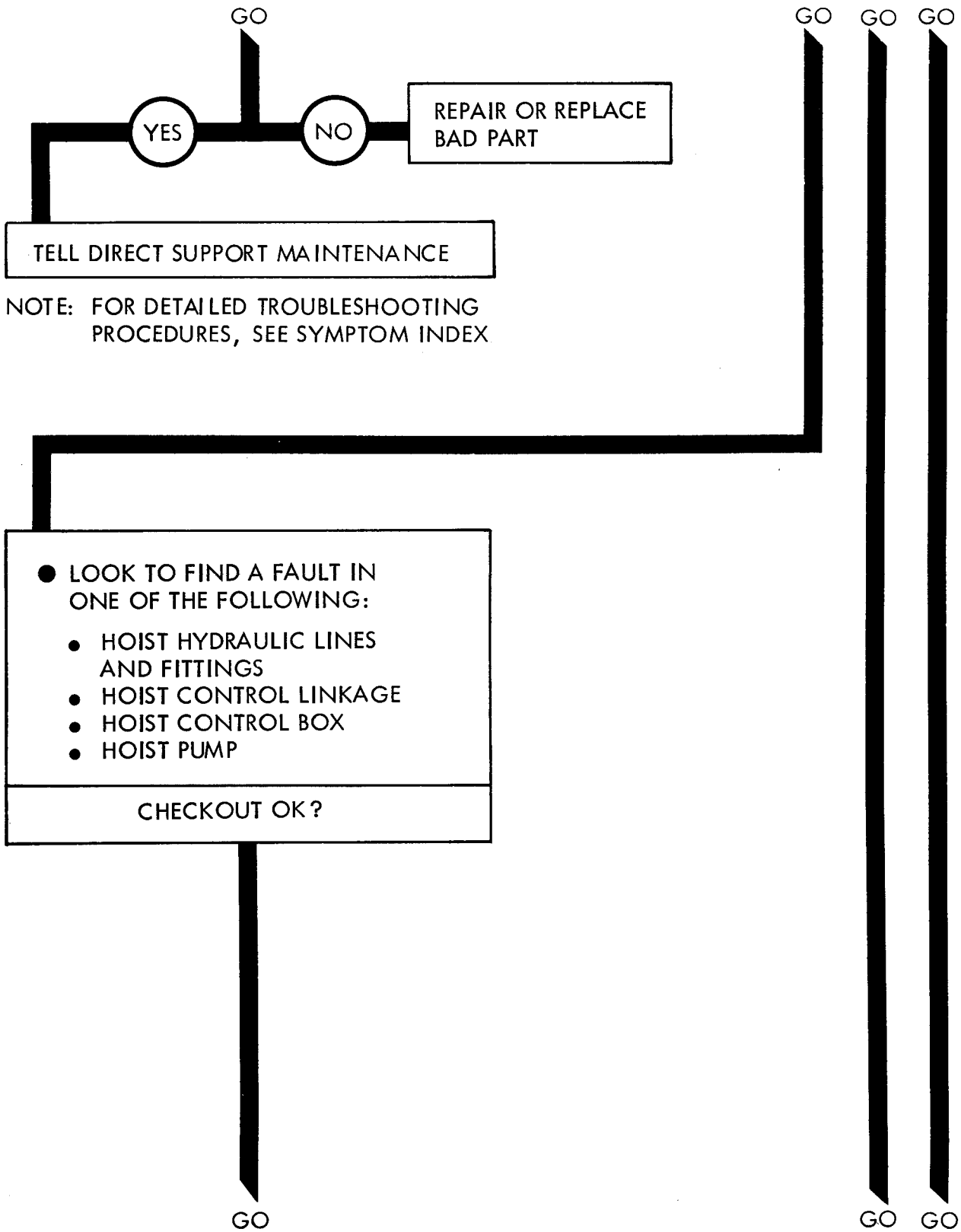

Figure 64-1 (Sheet 2 of 4)

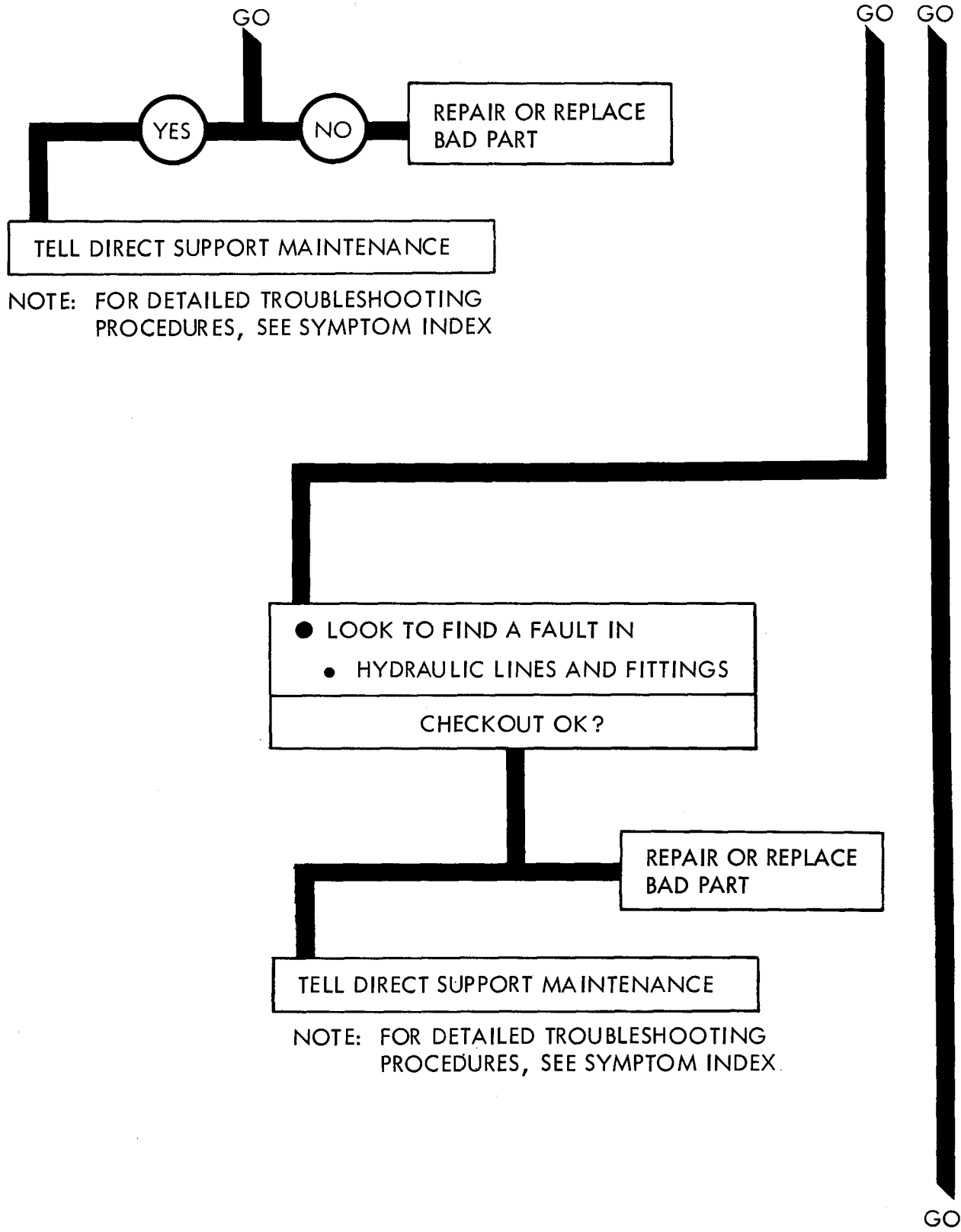
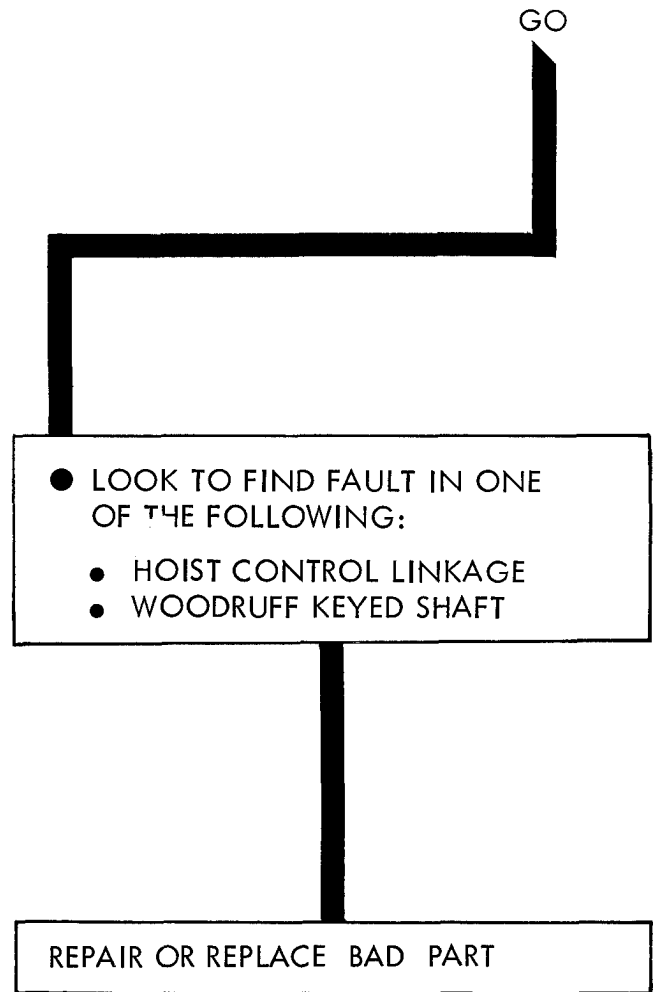

Figure 64-1 (Sheet 3 of 4)



NOTE: FOR DETAILED TROUBLESHOOTING PROCEDURES, SEE SYMPTOM INDEX

CHAPTER 65

DUMP BODY AND HOIST SYSTEM SUPPORT DIAGRAMS

65-1. GENERAL. This chapter gives the diagrams you need when doing troubleshooting procedures in chapter 63. Table 3-1 is a complete listing of all support diagrams used in this manual.

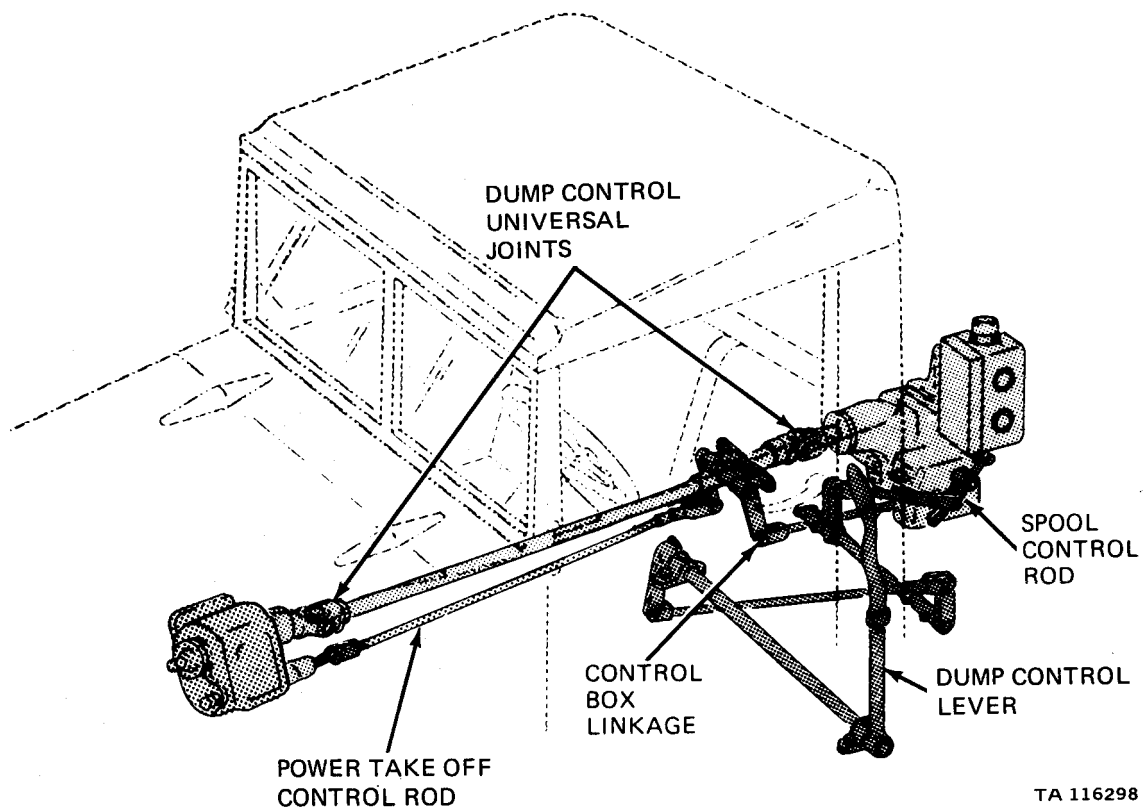

TA 116298

Figure 65-1 Dump Control Linkage

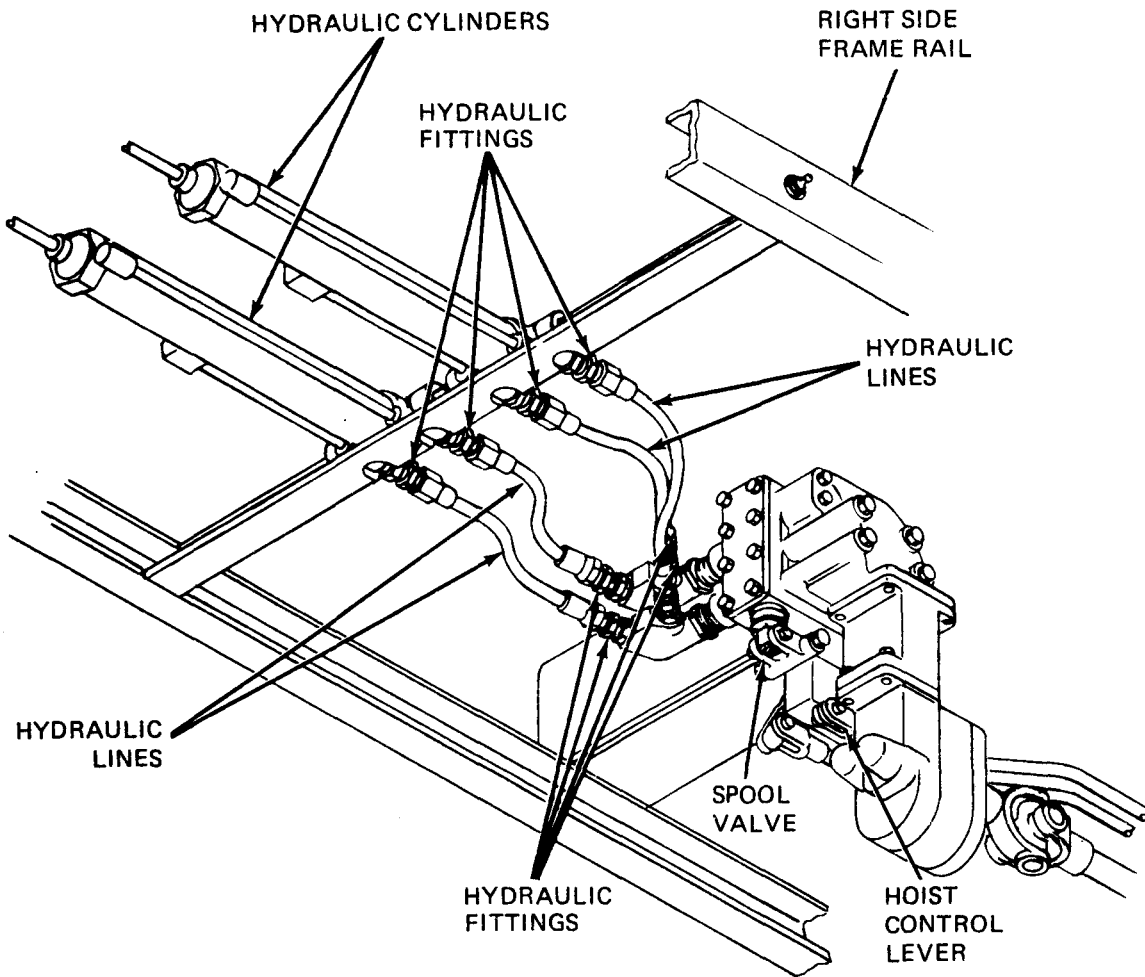

TA 116299

Figure 65-2 Dump Control Hydraulic System

CHAPTER 66

DUMP BODY AND HOIST SYSTEM TEST PROCEDURES

66-1. GENERAL. This chapter gives test procedures for the tests given in chapter 63, for the Dump and Hoist System.

66-2. TEST SET-UP. Instructions for setup of test equipment and parts to be tested are given before the test procedures. Illustrations are used, when needed, to show you how to hook up the test equipment to the part to be tested.

66-3. TEST PROCEDURES. Detailed step-by-step instructions, in flow chart form, are given for each test. The procedure calls out the type of test and the condition of the truck system for each part of testing. The step-by-step test will lead you to the bad component or to a fault symptom within a related system. Reference is made to the fault symptom index, chapter 6, if the test shows a fault in another system.

GENERAL INSTRUCTIONS

- Check pressure gage before using
 - Gage - See that the glass and needle are not broken
 - Fitting - Make sure fitting is on both ends. See if input end is dirt free

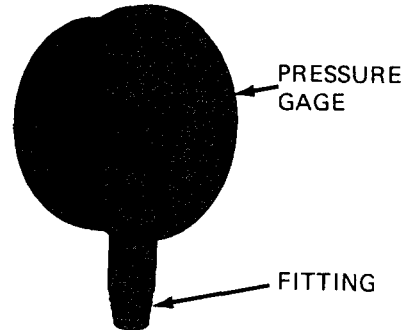

1 HOIST PUMP PRESSURE TEST
To measure hoist pump pressure at the input side of the hoist cylinders at 1000 rpm. Dump bed empty

1

- Set up gage as follows:
 - Using 1-1/4 and 1-3/8 inch wrenches, unscrew bottom control valve hose fitting
 - Put a bucket or can under hose and control valve manifold to catch hydraulic fluid
 - Screw gage adapter into control valve manifold adapter and tighten using 1-1/4 inch wrench
 - Screw control valve hose fitting into gage adapter and tighten using 1-3/8 inch wrench
 - Screw gage input fitting in gage adapter and tighten using 1-1/4 inch wrench

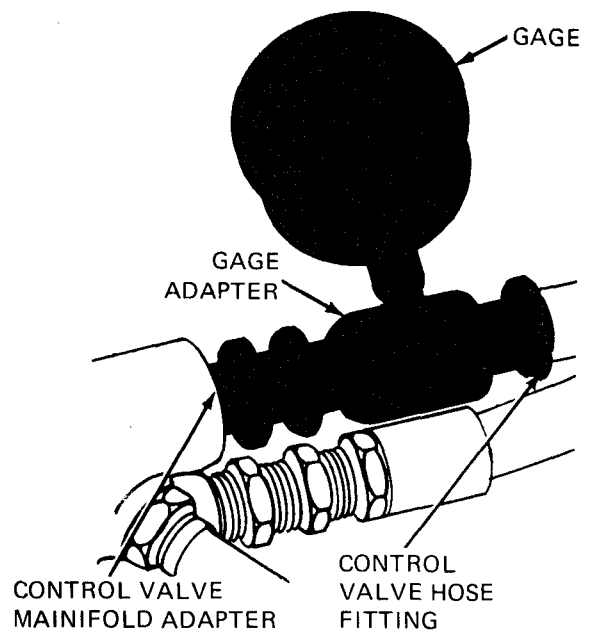

GO

Figure 66-1 (Sheet 1 of 3)

GO

NOTE

The next step will need the use of two soldiers. The lead soldier will be called Soldier A, and the helper will be called Soldier B

WARNING

This test will need to have Soldier A under the truck. To avoid injury make sure the truck wheels are chocked and the handbrake is set

2

● Test hoist pump pressure as follows

- SOLDIER B:
- Fill reservoir with hydraulic fluid. Refer to LO 9-2320-211-12
 - Start engine. Refer to TM 9-2320-211-10
 - Set engine at idle speed. Refer to TM 9-2320-211-10
 - Raise dump body. Refer to TM 9-2320-211-10

GO

TA 116301

Figure 66-1 (Sheet 2 of 3)

GO

SOLDIER A:

- Look for signs of leaks coming from fittings

Note: Leaking fittings will cause false readings. If the fittings leak, tell Soldier B to lower the dump body and stop the engine. Then tighten leaking fitting by using 1-3/8 inch wrench

- Tell Soldier B to keep engine running if there are no leaks

- See if pressure gage reads between 50 and 250 psi while dump body is rising

Note: As dump body raises the pressure reading on the gage will drop. When the dump reaches the top of its travel the reading will drop to 0 psi

- Tell Soldier B to lower dump body

SOLDIER B:

- Lower dump body. Refer to TM 9-2320-211-10

Figure 66-1 (Sheet 3 of 3)

2 HOIST CONTROL BOX TEST

NOTE

This test will need the use of two soldiers. The lead soldier will be called Soldier A and the helper will be called Soldier B.

1

- Test hoist control box as follows
- SOLDIER B: ● Sit in driver's seat and wait for instructions from Soldier A
- SOLDIER A: ● Crawl under truck
- Tell Soldier B to move dump control lever to POWER DOWN position
- SOLDIER B: ● Take off lock and move dump control lever forward to POWER DOWN position
- SOLDIER A: ● See if power takeoff rod moves toward front of truck. See figure 65-1

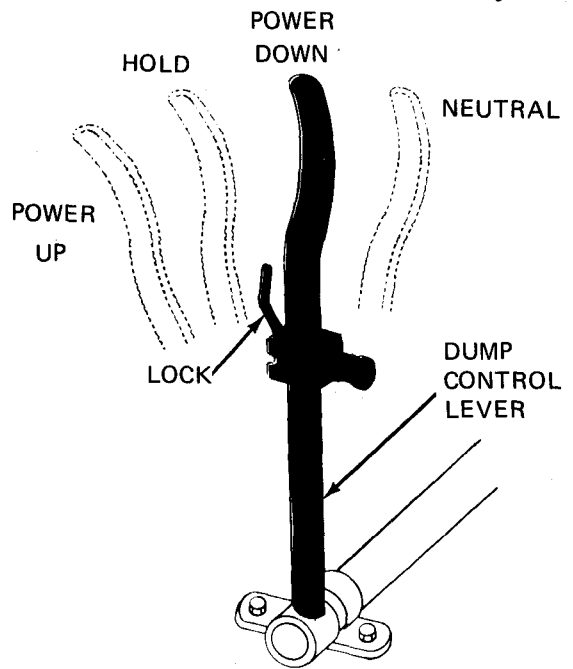
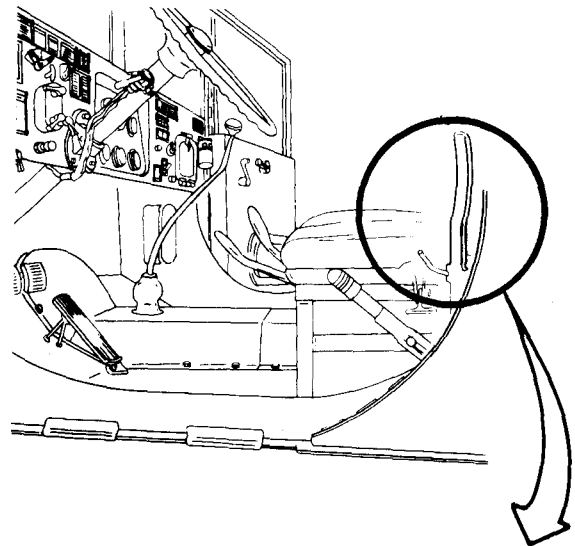

GO

Figure 66-2 (Sheet 1 of 2)

TA 116303

GO

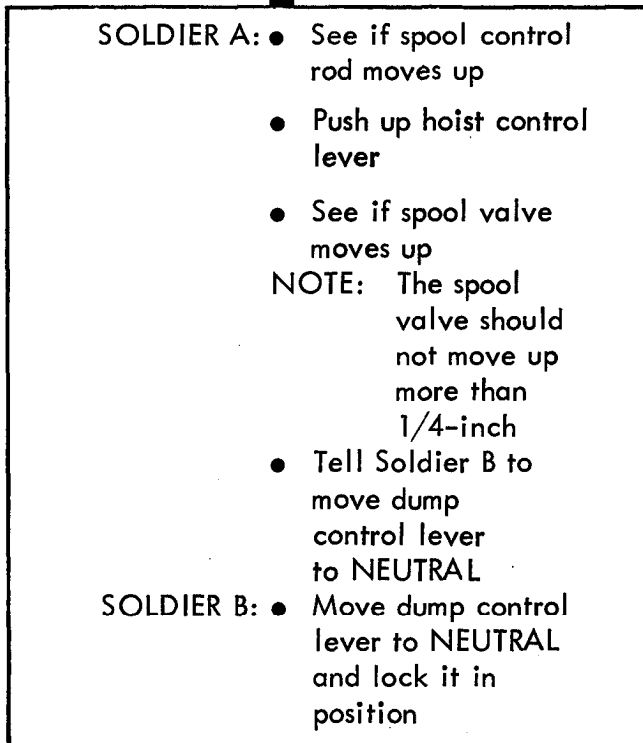
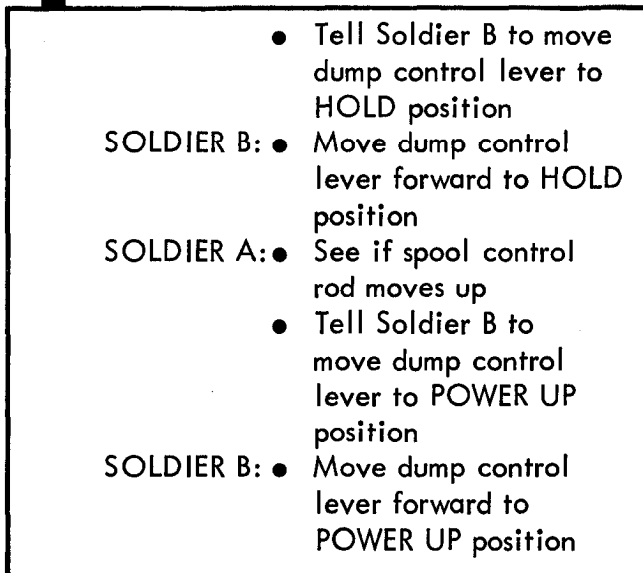

Figure 66-2 (Sheet 2 of 2)

3

CONTROL LINKAGE WOODRUFF KEYED SHAFT CHECK

- Check control linkage woodruff keyed shafts
 - Take off control linkage at control box. Tell direct support maintenance
- Note: Control linkage is attached to a control box lever on the control box. This lever is attached to control box by a woodruffed keyed shaft. This shaft is visible where the control box lever attaches to the shaft
- Move control box lever and see if shaft turns with lever

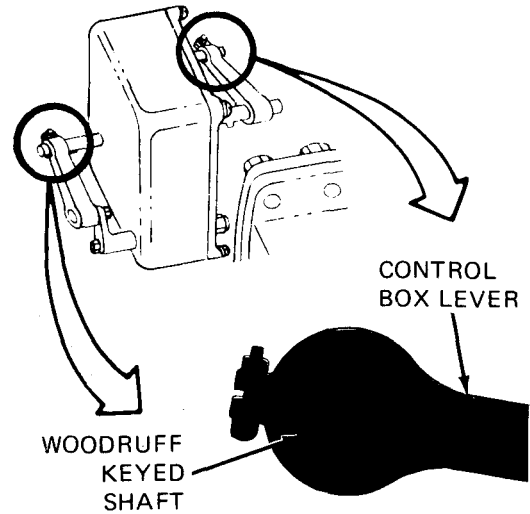

Figure 66-3

TA 116305

CHAPTER 67

DUMP BODY AND HOIST SYSTEM CHECKOUT PROCEDURES

67-1. GENERAL. This chapter gives procedures for checking out the system after troubleshooting and repair have been done. Procedures are set up in flow chart form showing the checkout steps in order and referring to the fault symptom index when the system does not checkout.

DUMP BODY AND HOIST SYSTEM CHECKOUT

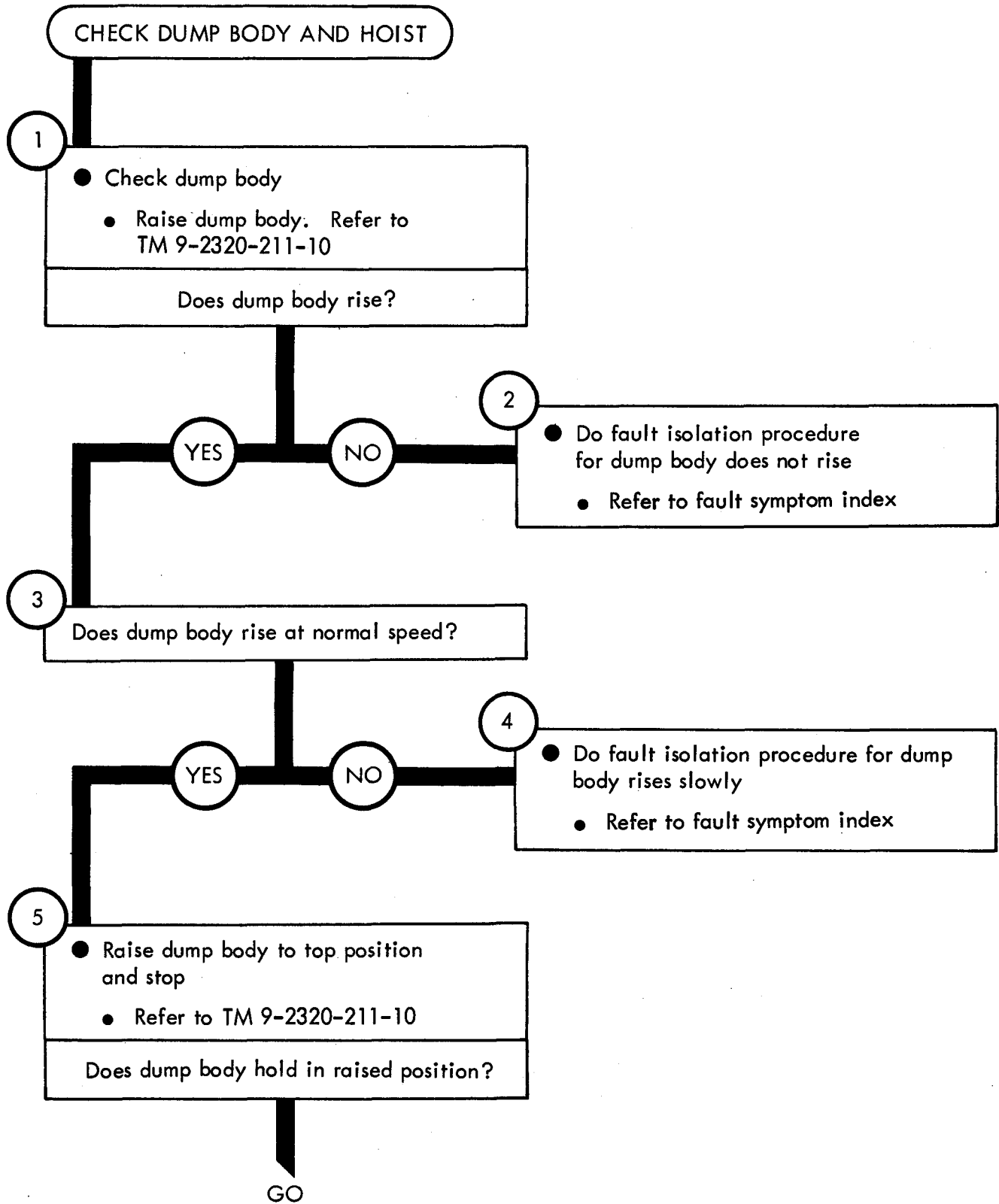

Figure 67-1 (Sheet 1 of 2)

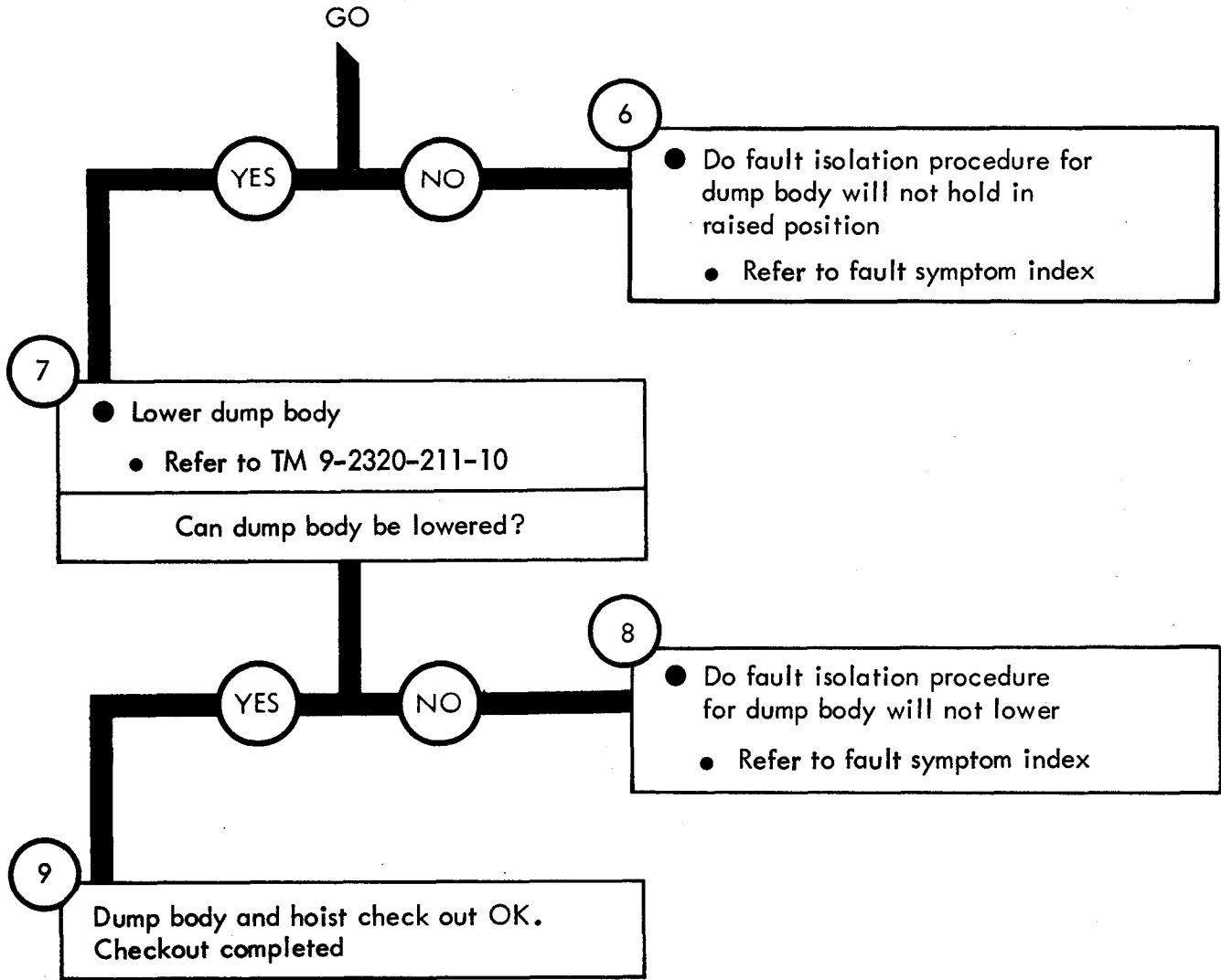

Figure 67-1 (Sheet 2 of 2)

CHAPTER 68

REAR WINCH TROUBLESHOOTING

68-1. EQUIPMENT ITEMS COVERED. This chapter gives equipment troubleshooting procedures for the rear winch system, for which there are authorized corrective maintenance tasks at the organizational maintenance level.

68-2. EQUIPMENT ITEMS NOT COVERED. All equipment items for which corrective maintenance is authorized at the organizational maintenance level are covered in this chapter.

REAR WINCH TROUBLESHOOTING

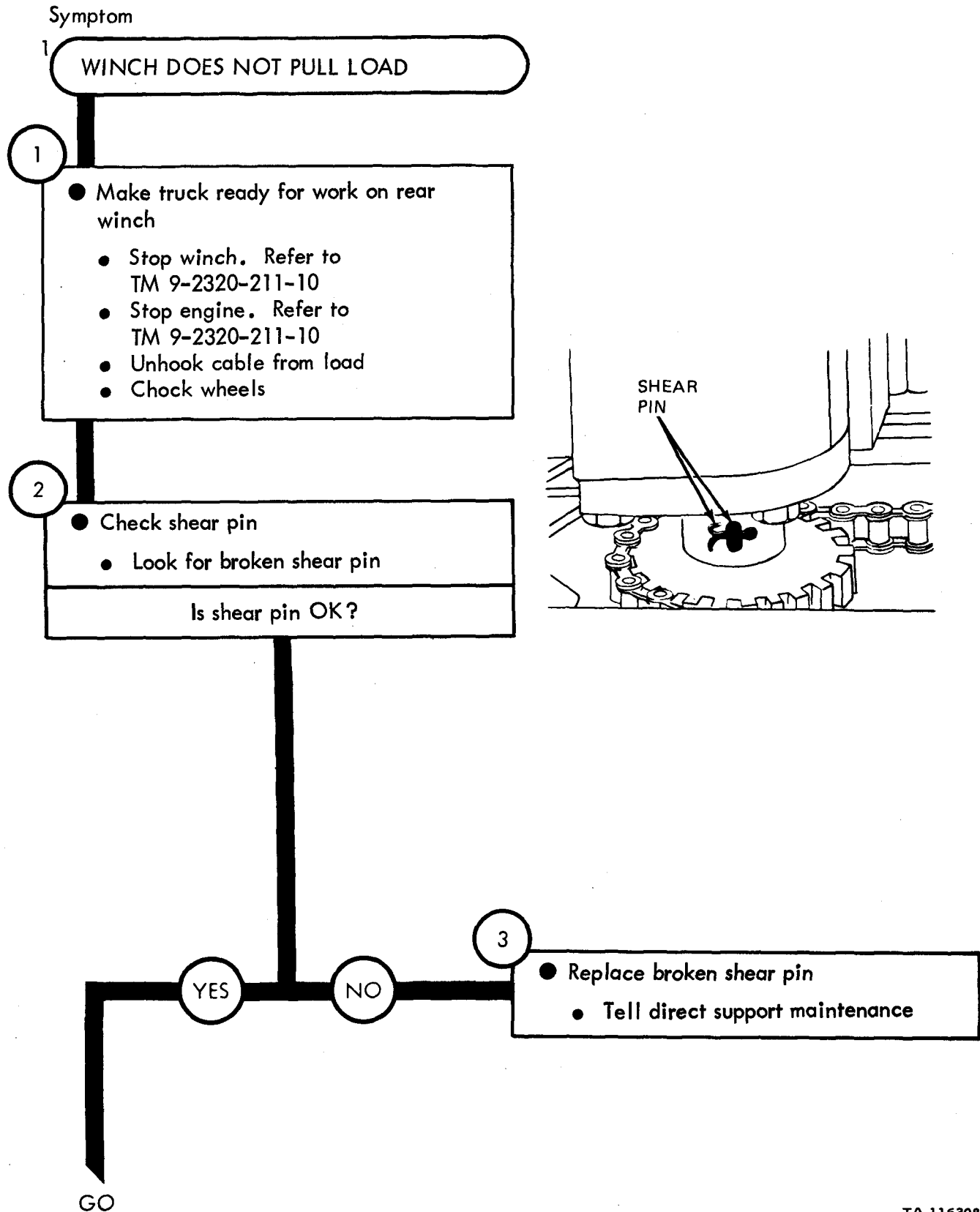

Figure 68-1 (Sheet 1 of 4)

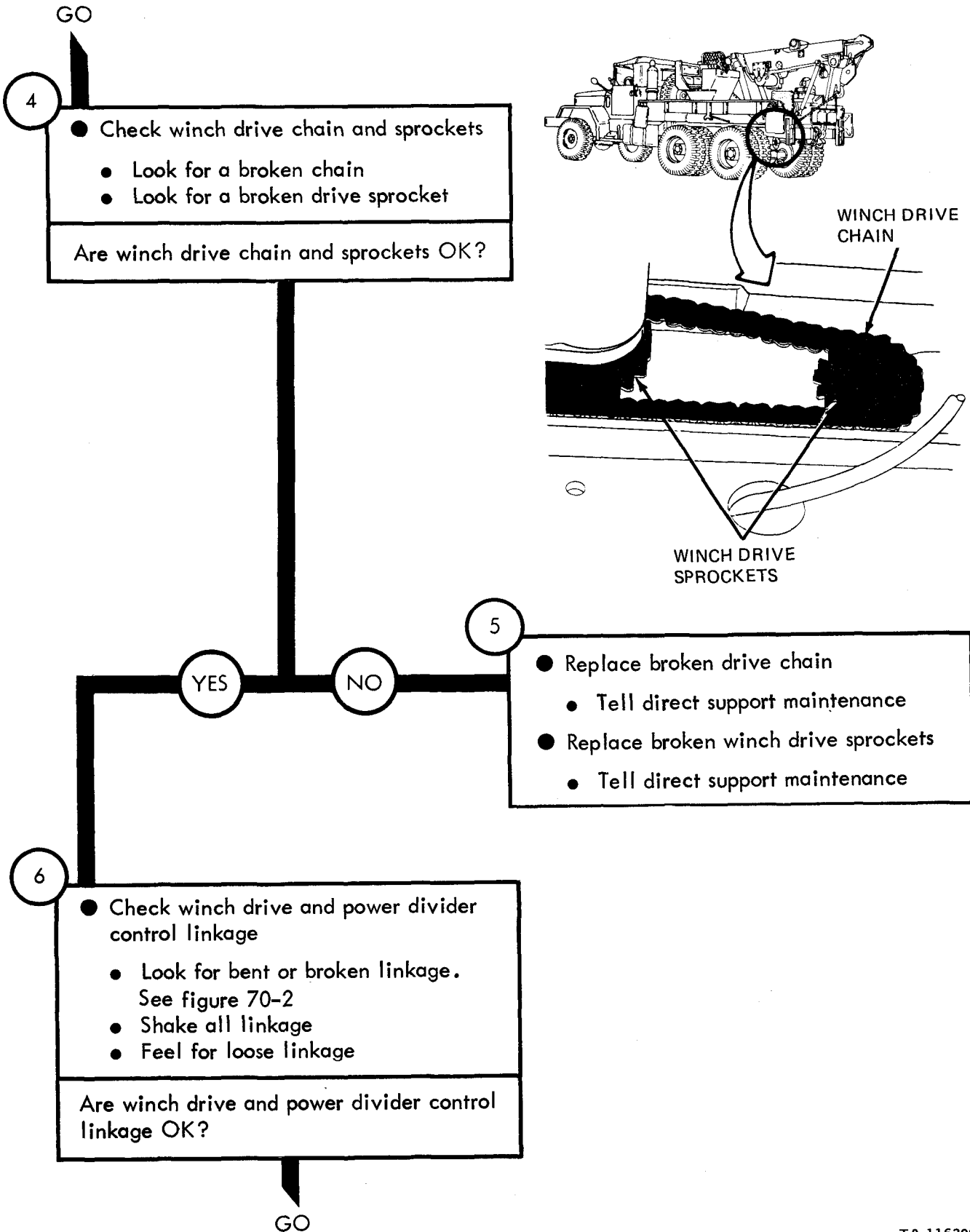

Figure 68-1 (Sheet 2 of 4)

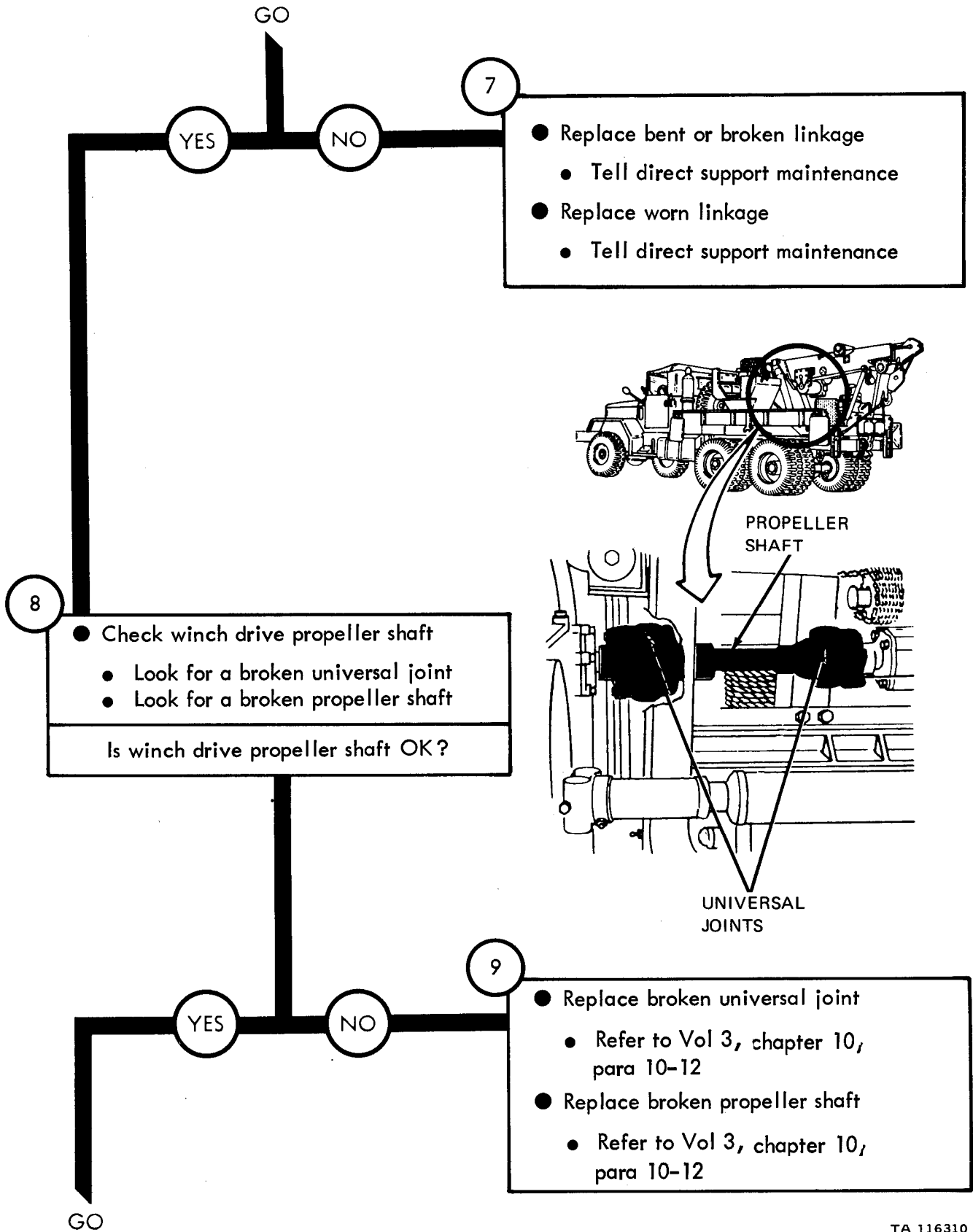
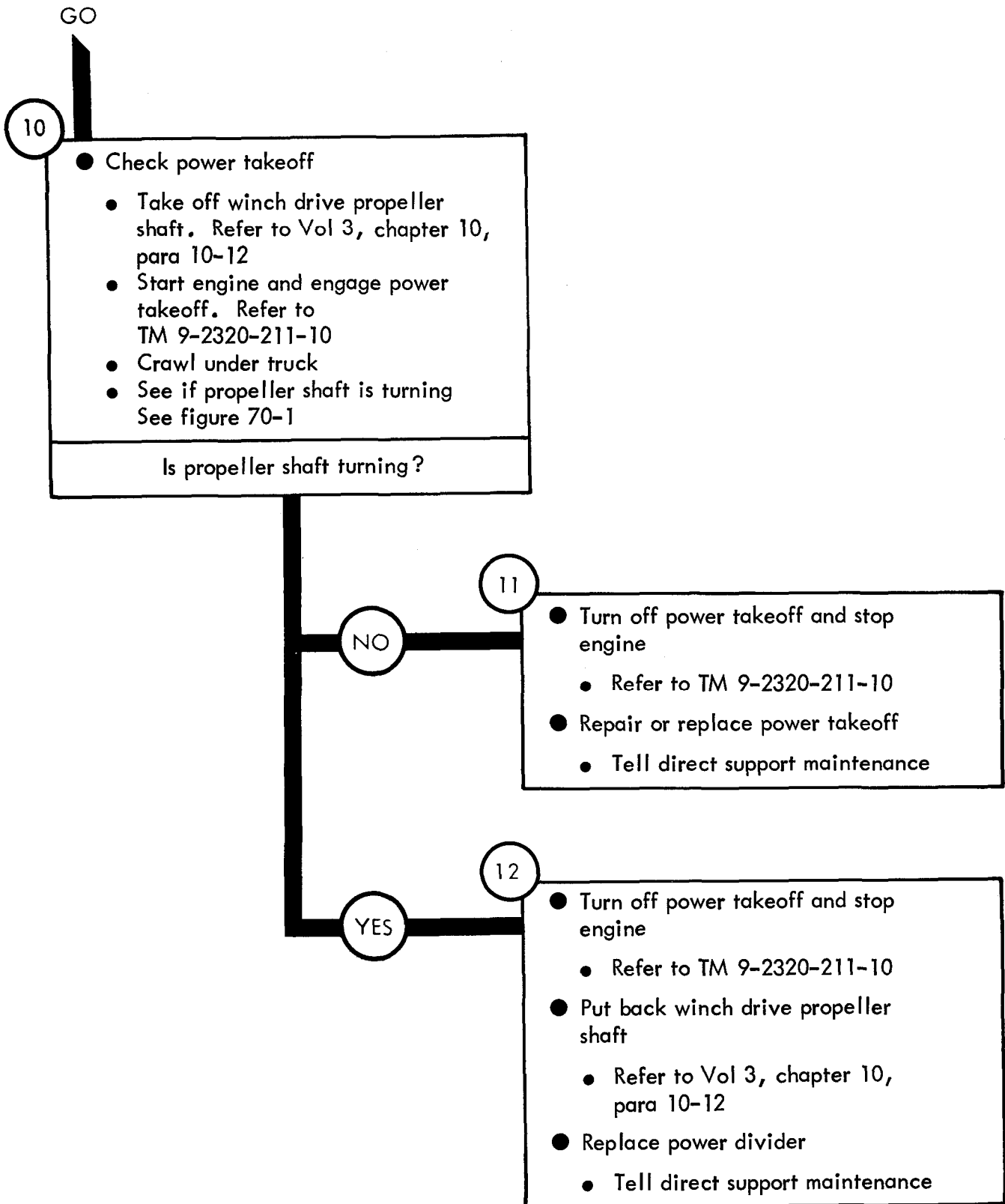

Figure 68-1 (Sheet 3 of 4)

TA 116310



TA 116311

Figure 68-1 (Sheet 4 of 4)

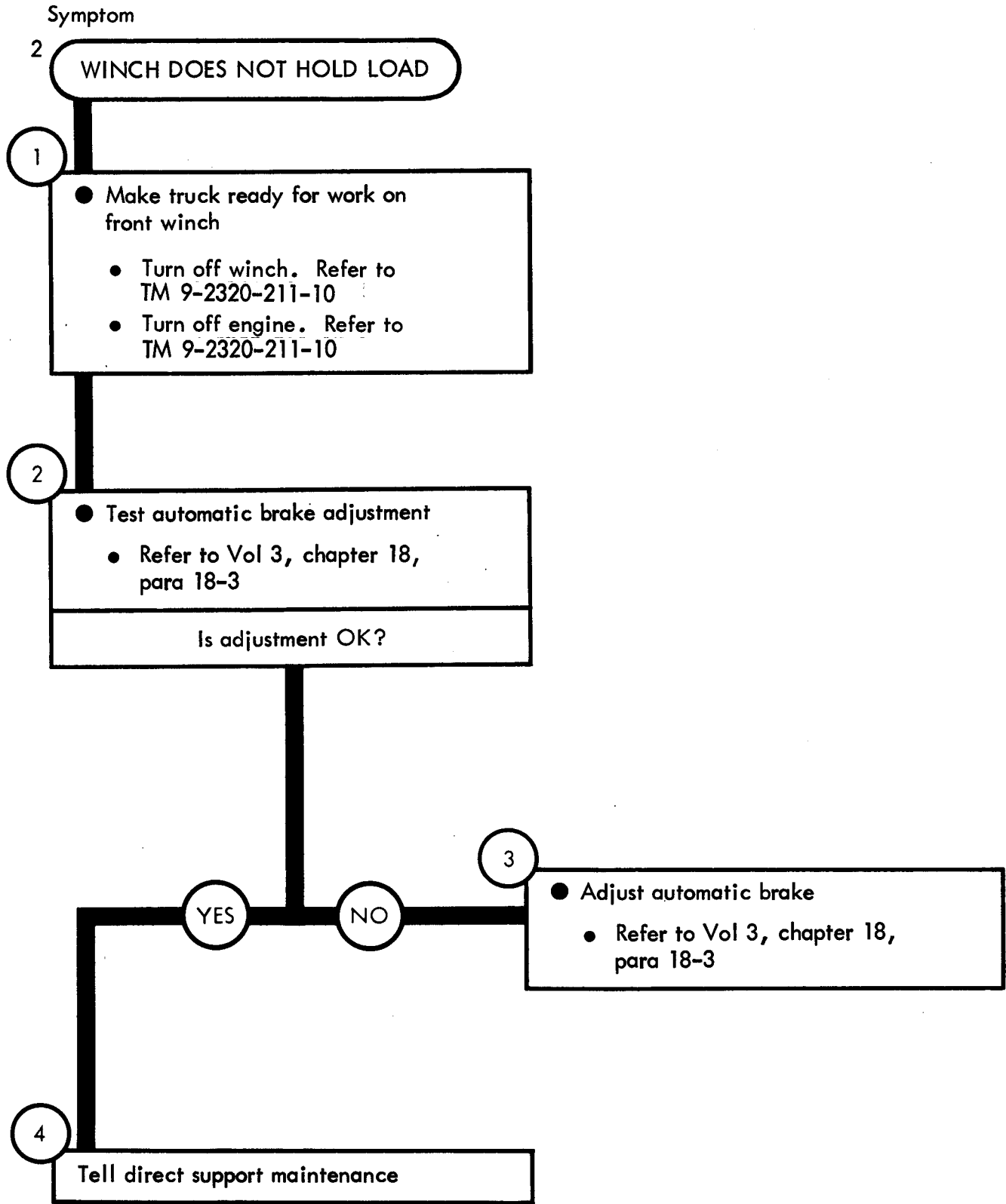

Figure 68-2

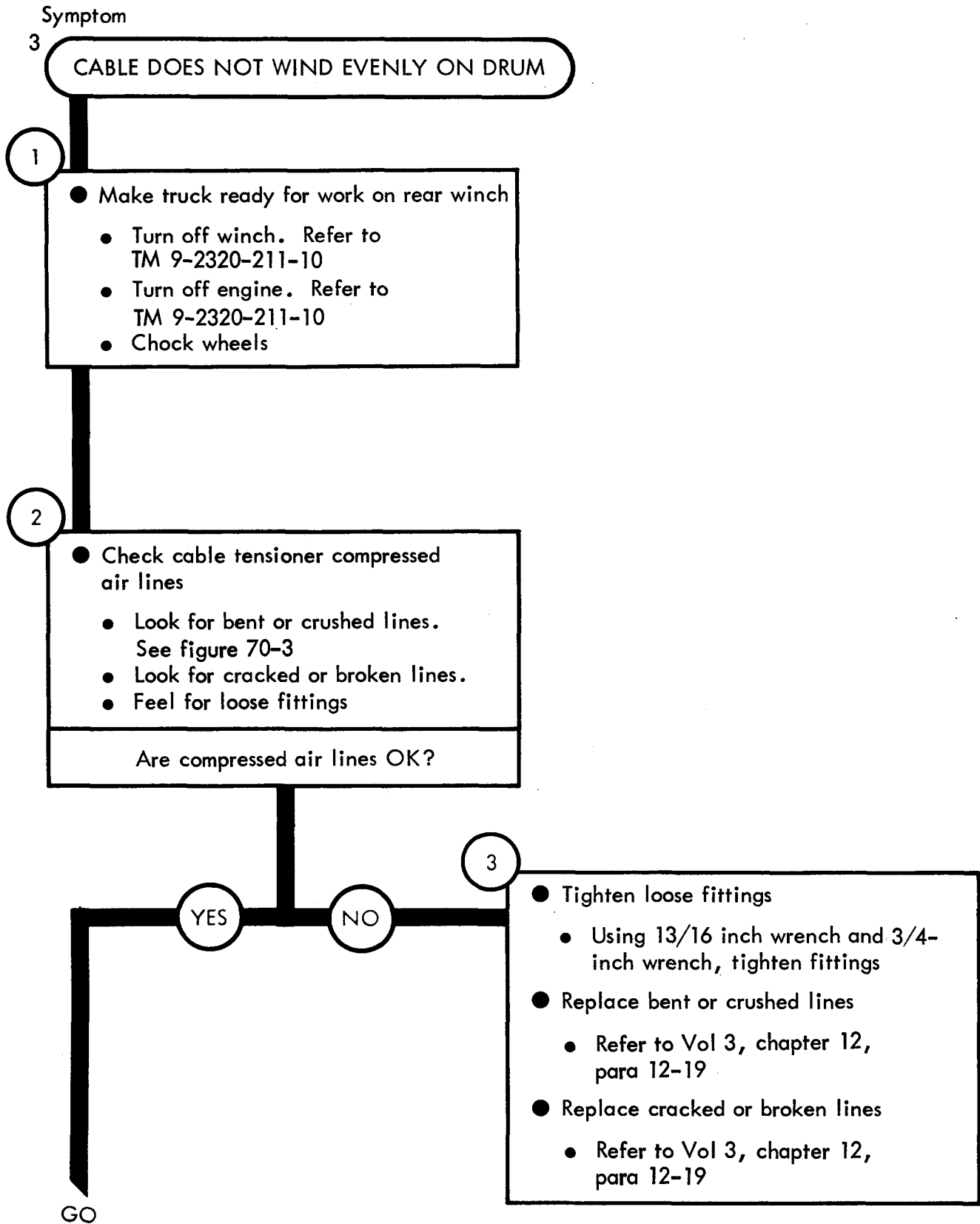
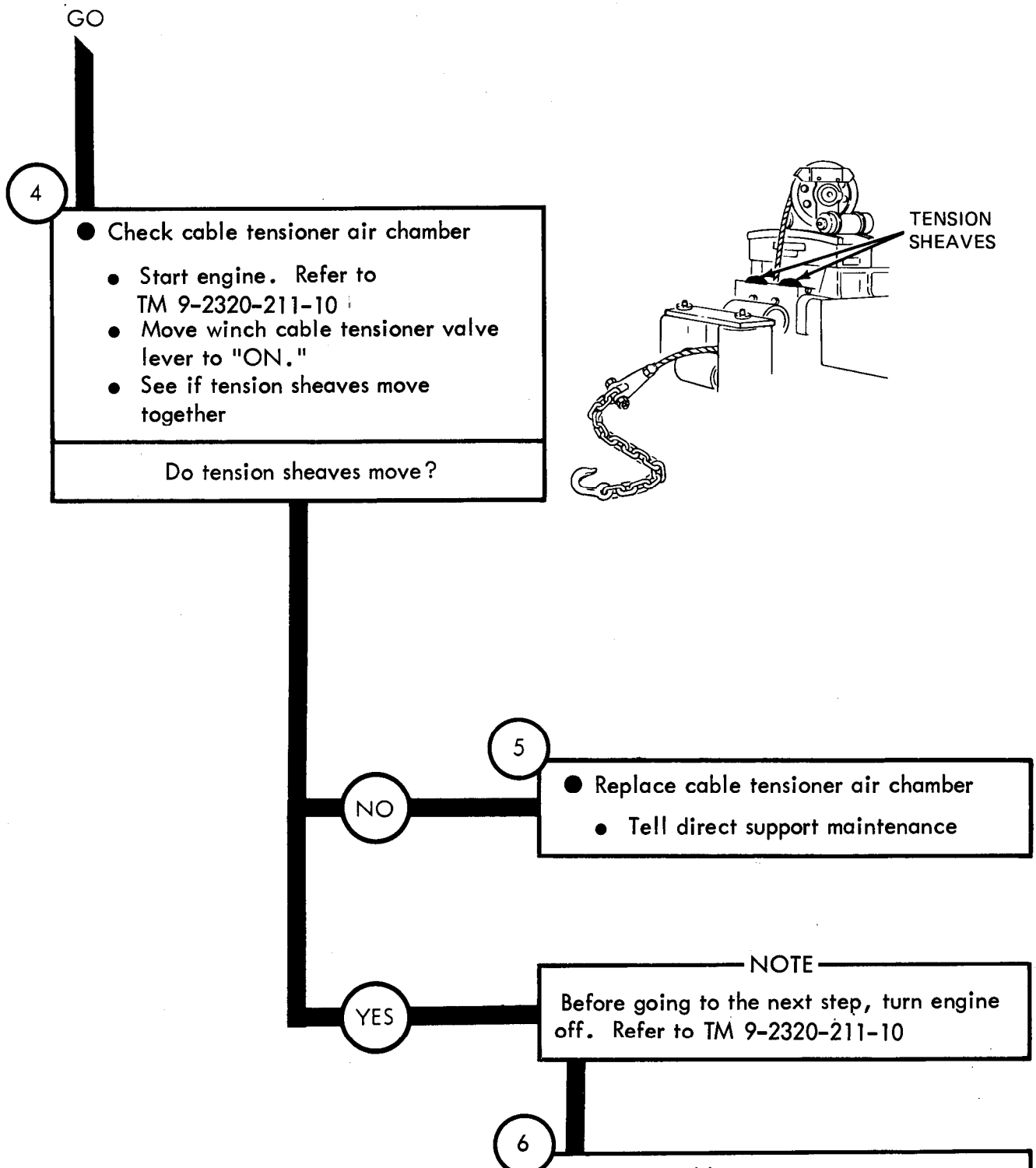

Figure 68-3 (Sheet 1 of 2)



chapter 18,
para 18-9

Figure 68-3 (Sheet 2 of 2)

CHAPTER 69

REAR WINCH TROUBLESHOOTING SUMMARY

69-1. GENERAL. This chapter gives a summary of troubleshooting procedures given in chapter 68, for the Rear Winch System.

69-2. PROCEDURES. The summary in this chapter covers all fault symptoms found in the detailed troubleshooting procedures in Part 1. Chapter 7 outlines a sample troubleshooting procedure. The summary procedures are based on the "what-to-do" portions of the detailed procedures and do not include the "How-to-do-it" instructions. Warnings, cautions, and notes are given where needed.

REAR WINCH SYSTEM TROUBLESHOOTING SUMMARY

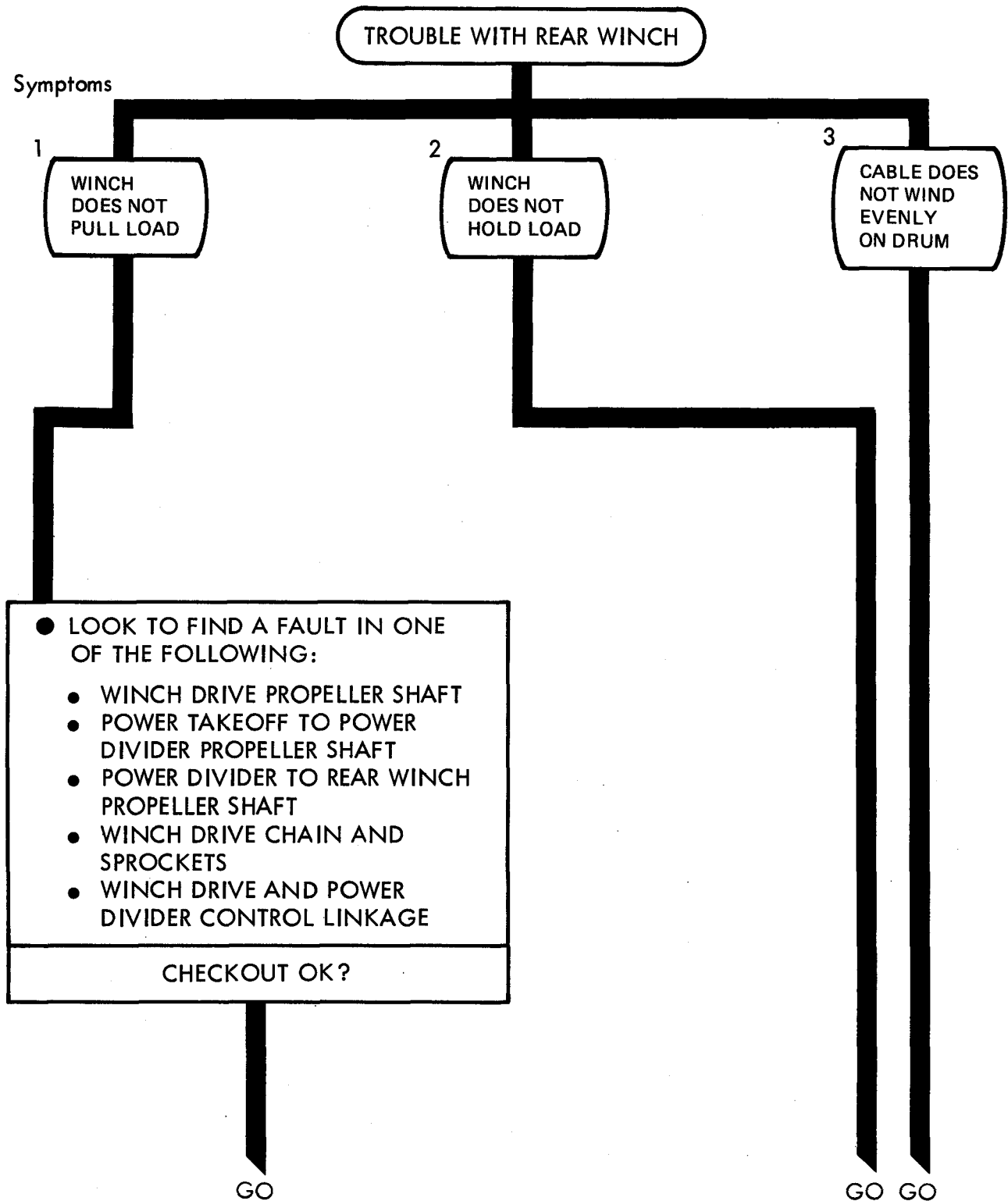
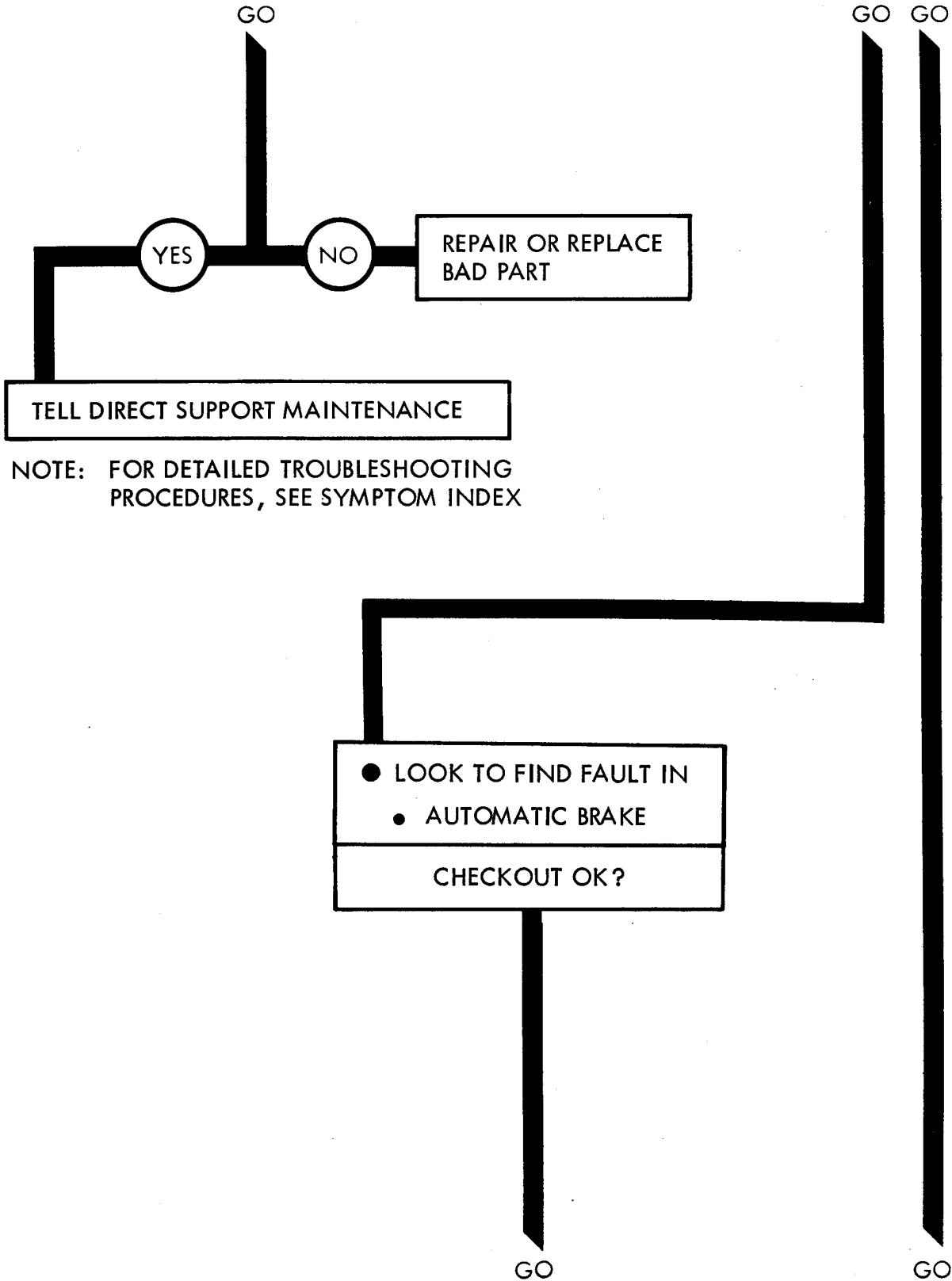

Figure 69-1 (Sheet 1 of 3)



NOTE: FOR DETAILED TROUBLESHOOTING PROCEDURES, SEE SYMPTOM INDEX

Figure 69-1 (Sheet 2 of 3)

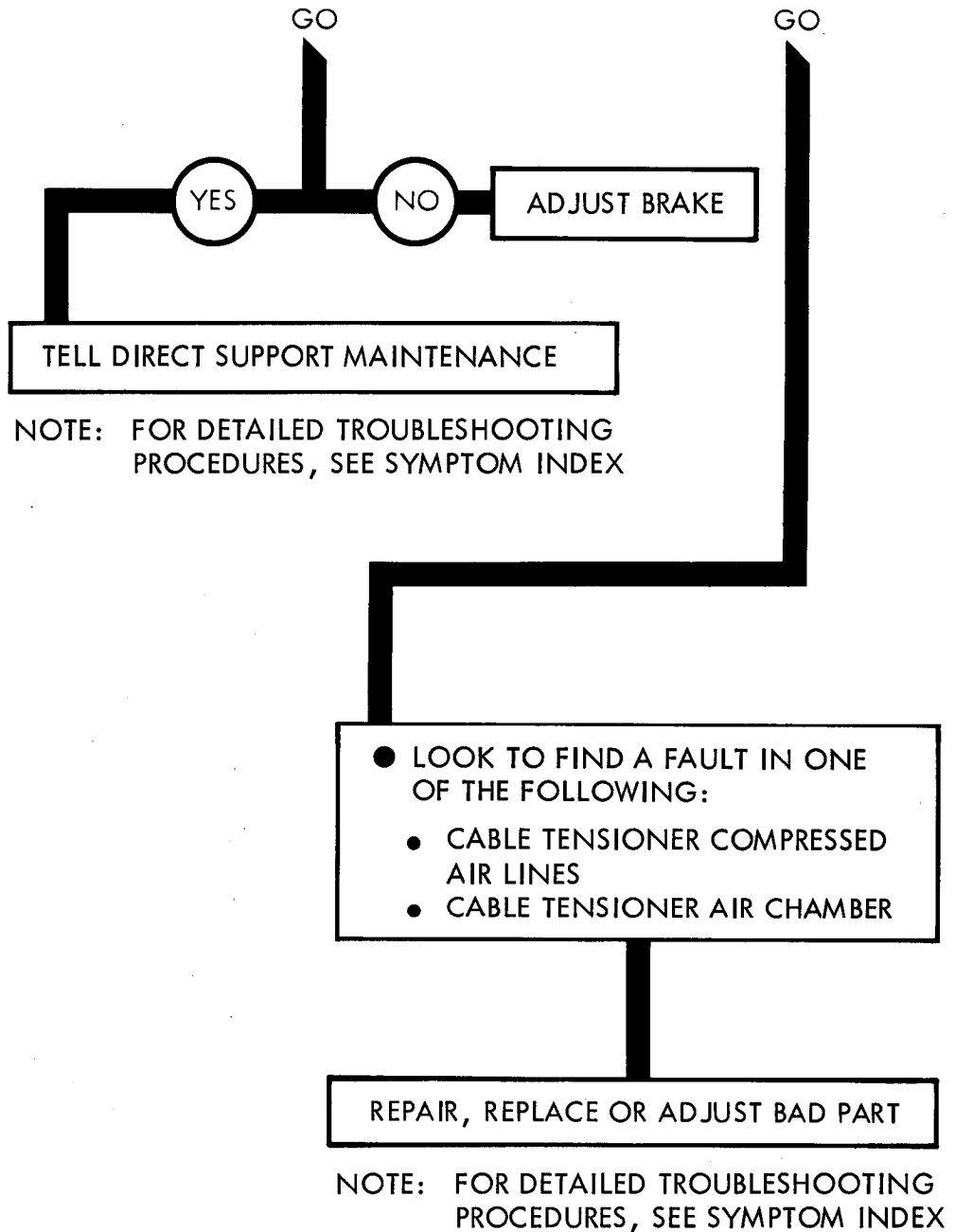
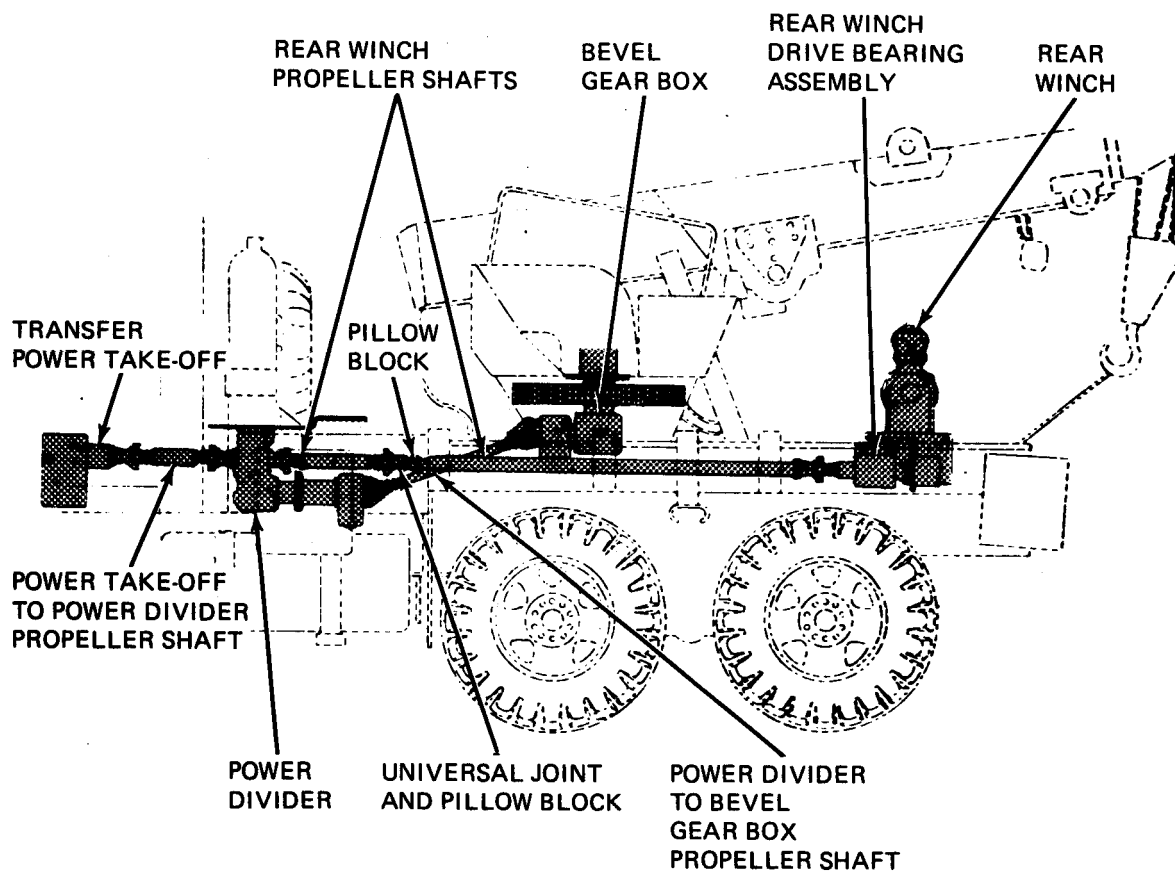

Figure 69-1 (Sheet 3 of 3)

CHAPTER 70

REAR WINCH SUPPORT DIAGRAMS

70-1. GENERAL. This chapter gives the diagrams you need when doing troubleshooting procedures in chapter 68. Table 3-1 is a complete listing of all support diagrams used in this manual.



TA 116318

Figure 70-1. Rear winch

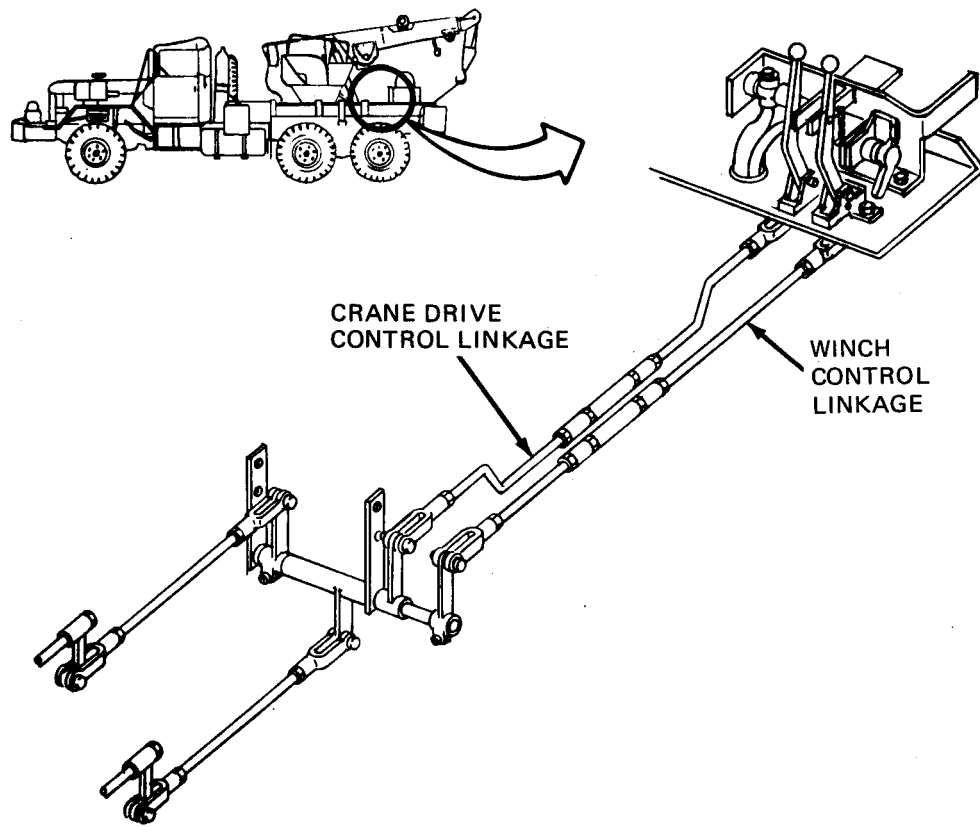

TA 116319

Figure 70-2. Rear Winch Linkage

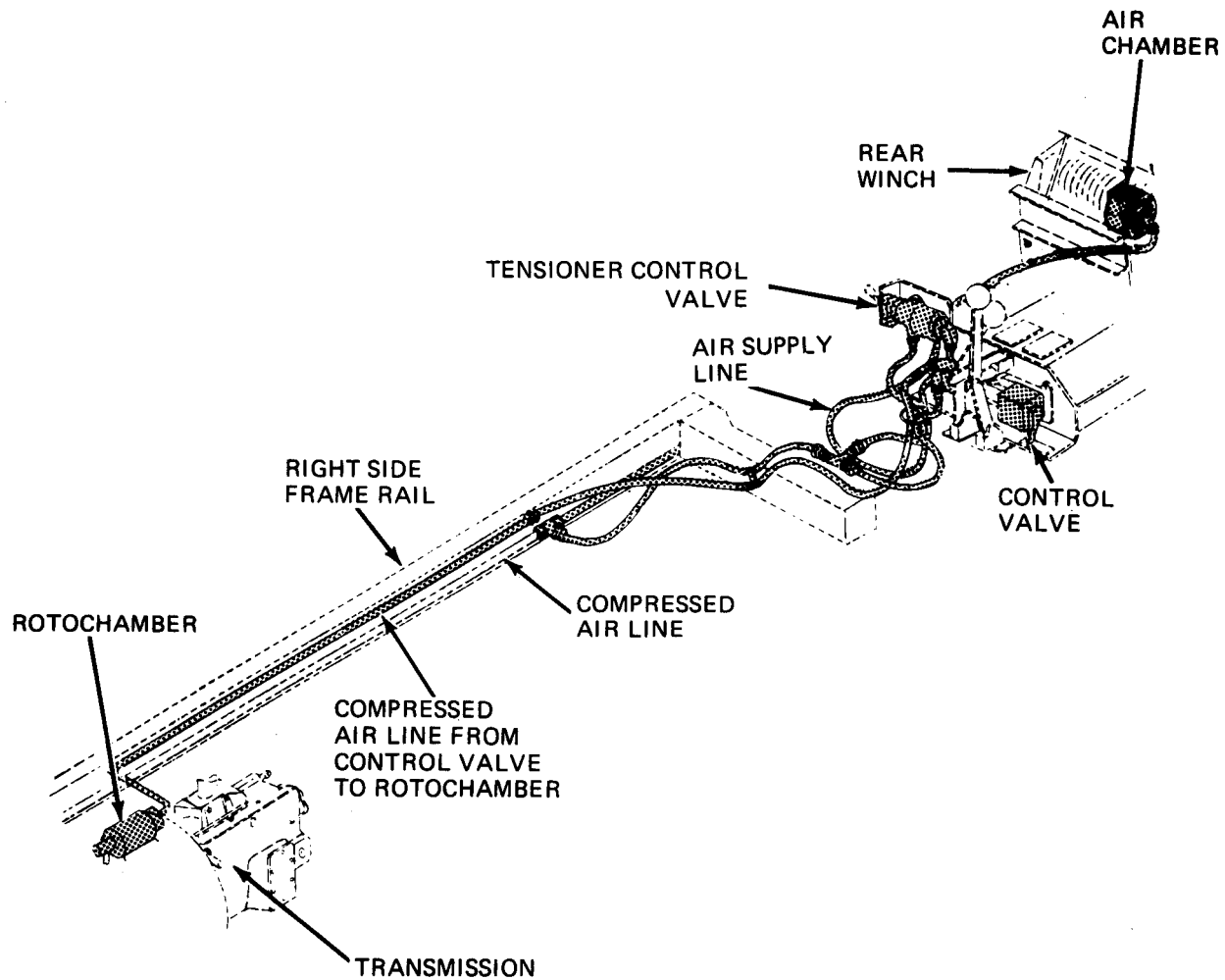

TA 116320

Figure 70-3. Rear Winch Air Lines

CHAPTER 71

REAR WINCH CHECKOUT PROCEDURES

71-1. GENERAL. This chapter gives procedures for checking out the system after troubleshooting and repair have been done. Procedures are set up in flow chart form showing the checkout steps in order and referring to the fault symptom index when the system does not checkout.

REAR WINCH CHECKOUT

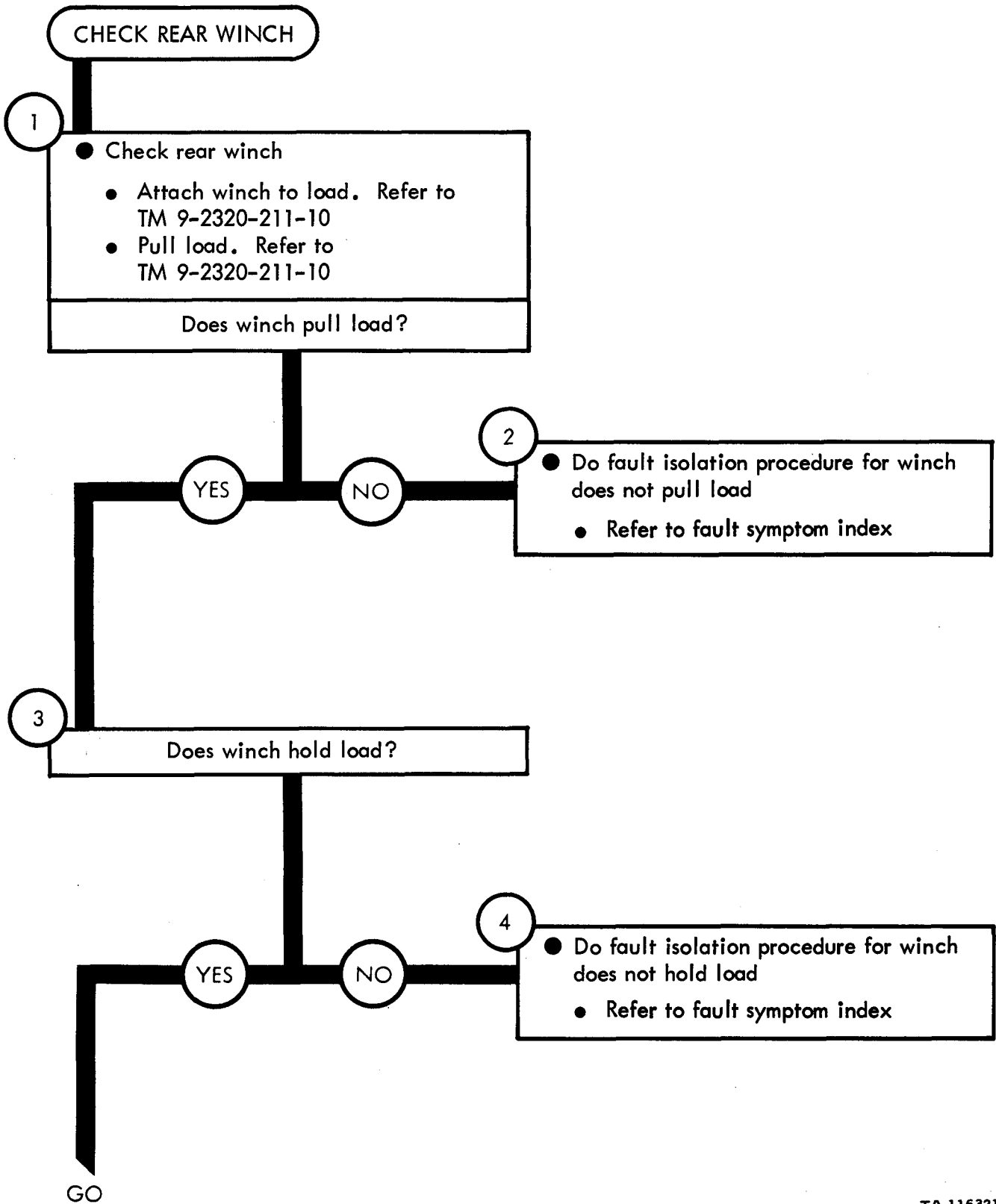

Figure 71-1 (Sheet 1 of 2)

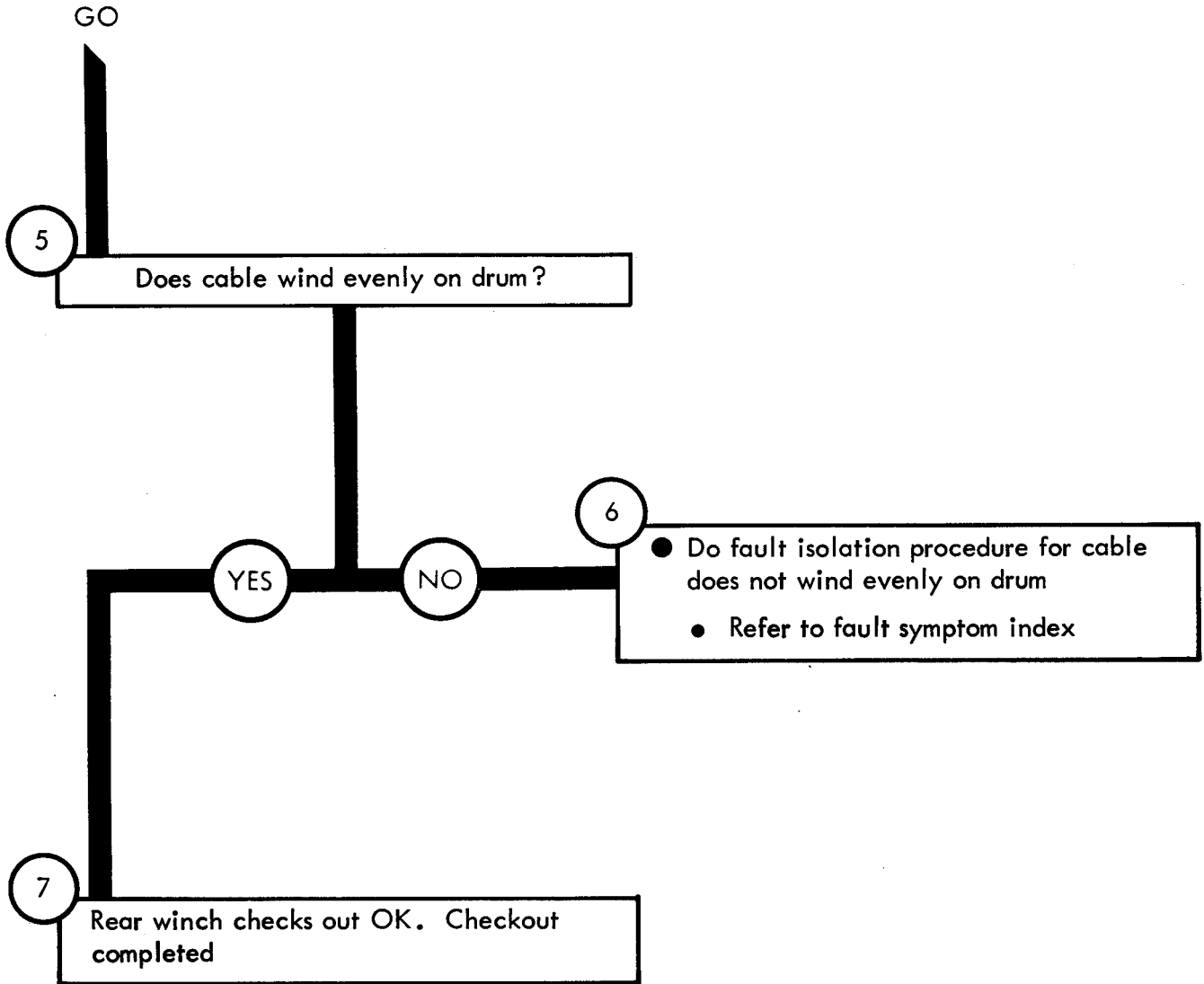

Figure 71-1 (Sheet 2 of 2)

CHAPTER 72

WRECKER SYSTEM TROUBLESHOOTING

72-1. EQUIPMENT ITEMS COVERED. This chapter gives equipment troubleshooting procedures for the wrecker system, for which there are authorized corrective maintenance tasks at the organizational maintenance level.

72-2. EQUIPMENT ITEMS NOT COVERED . All equipment items for which corrective maintenance is authorized at the organizational maintenance level are covered in this chapter.

Symptom

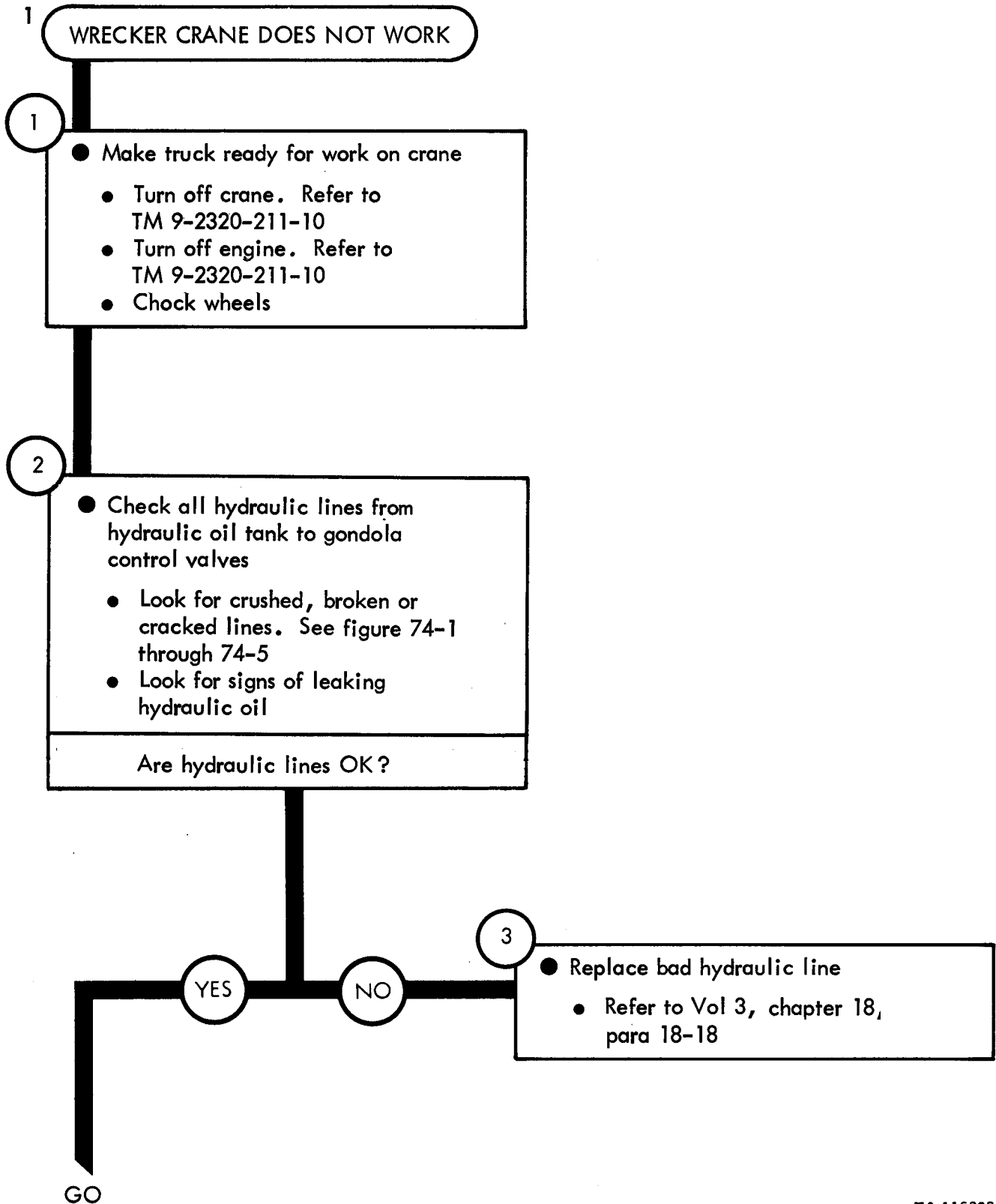

Figure 72-1 (Sheet 1 of 6)

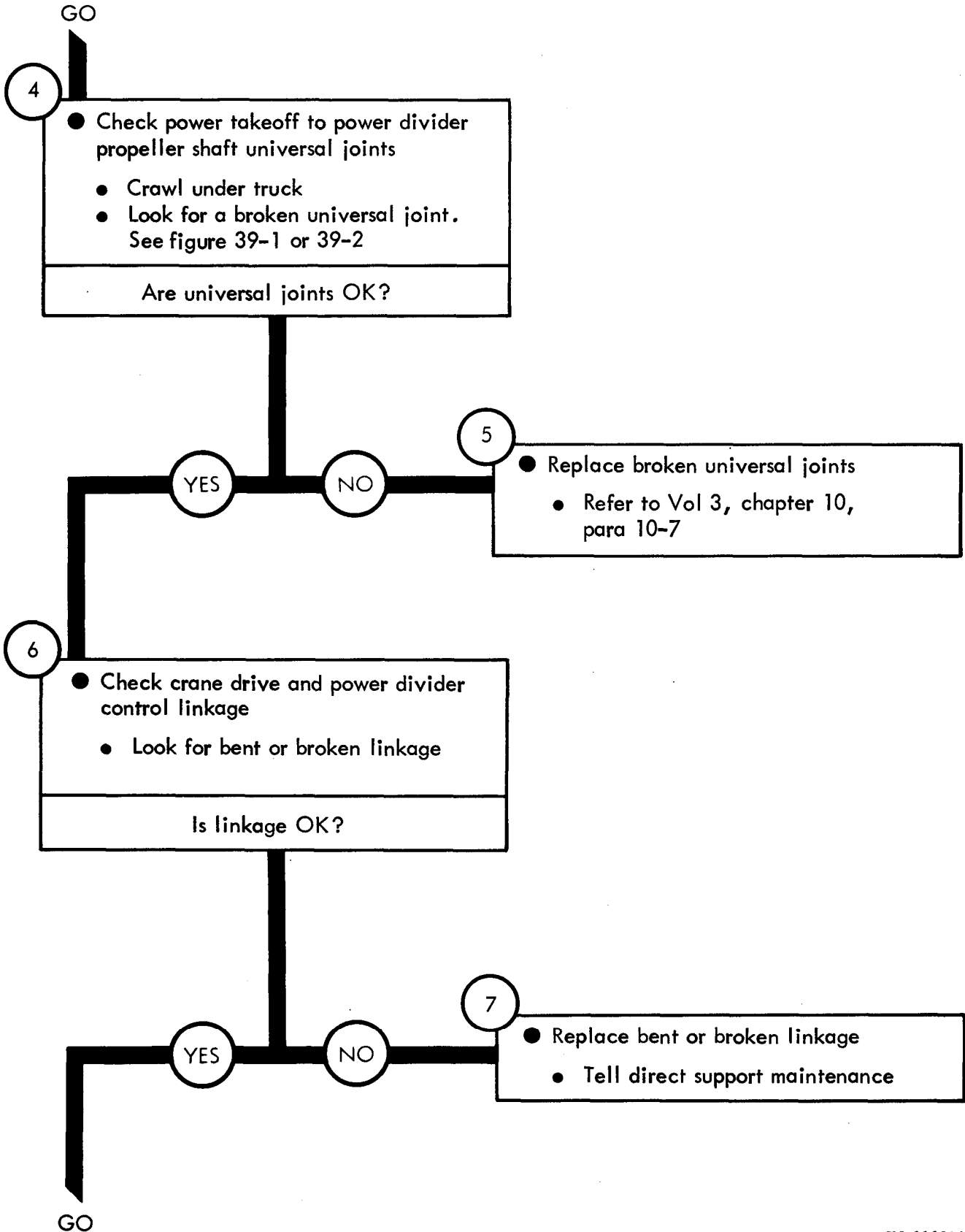

Figure 72-1 (Sheet 2 of 6)

TA 116324

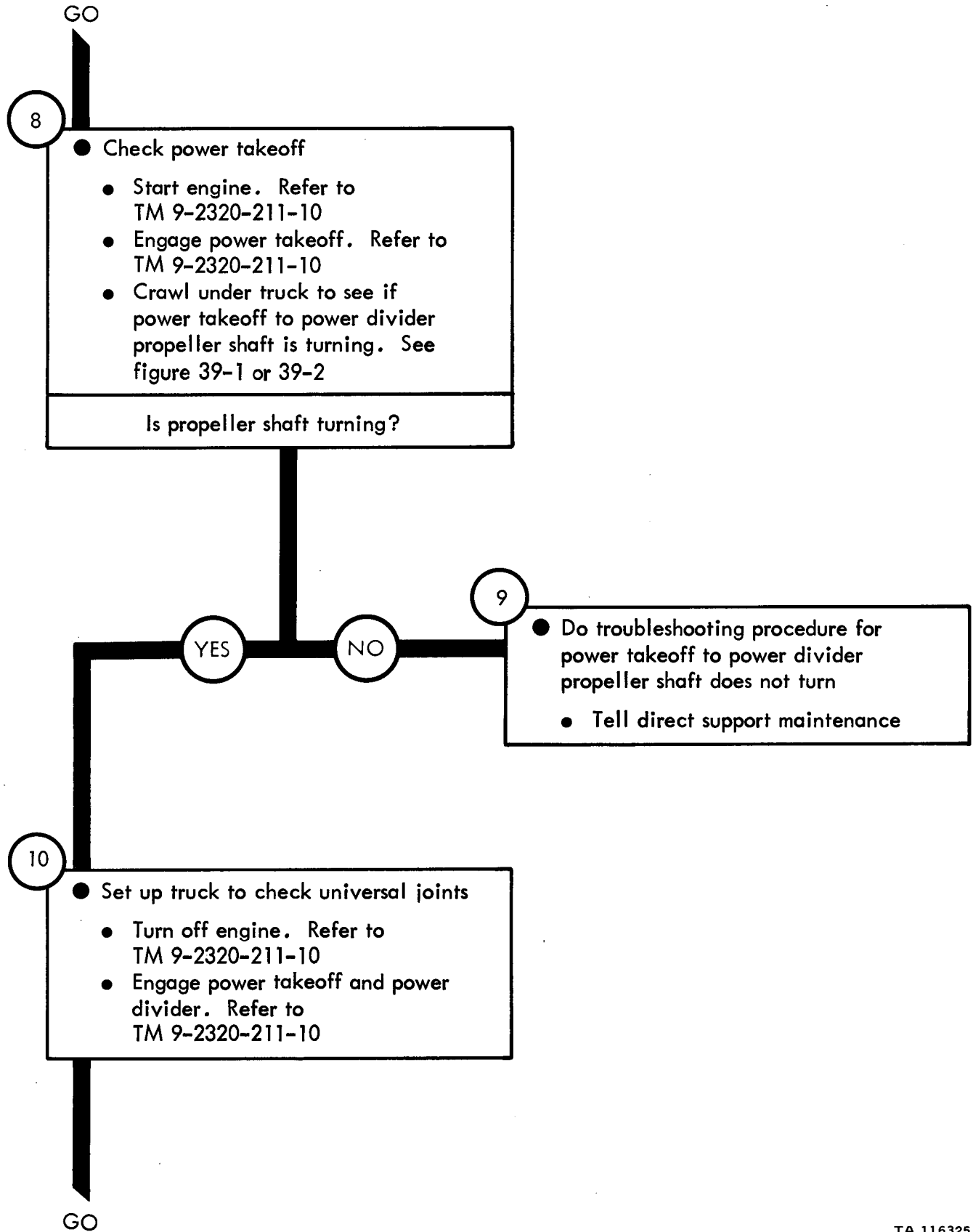

Figure 72-1 (Sheet 3 of 6)

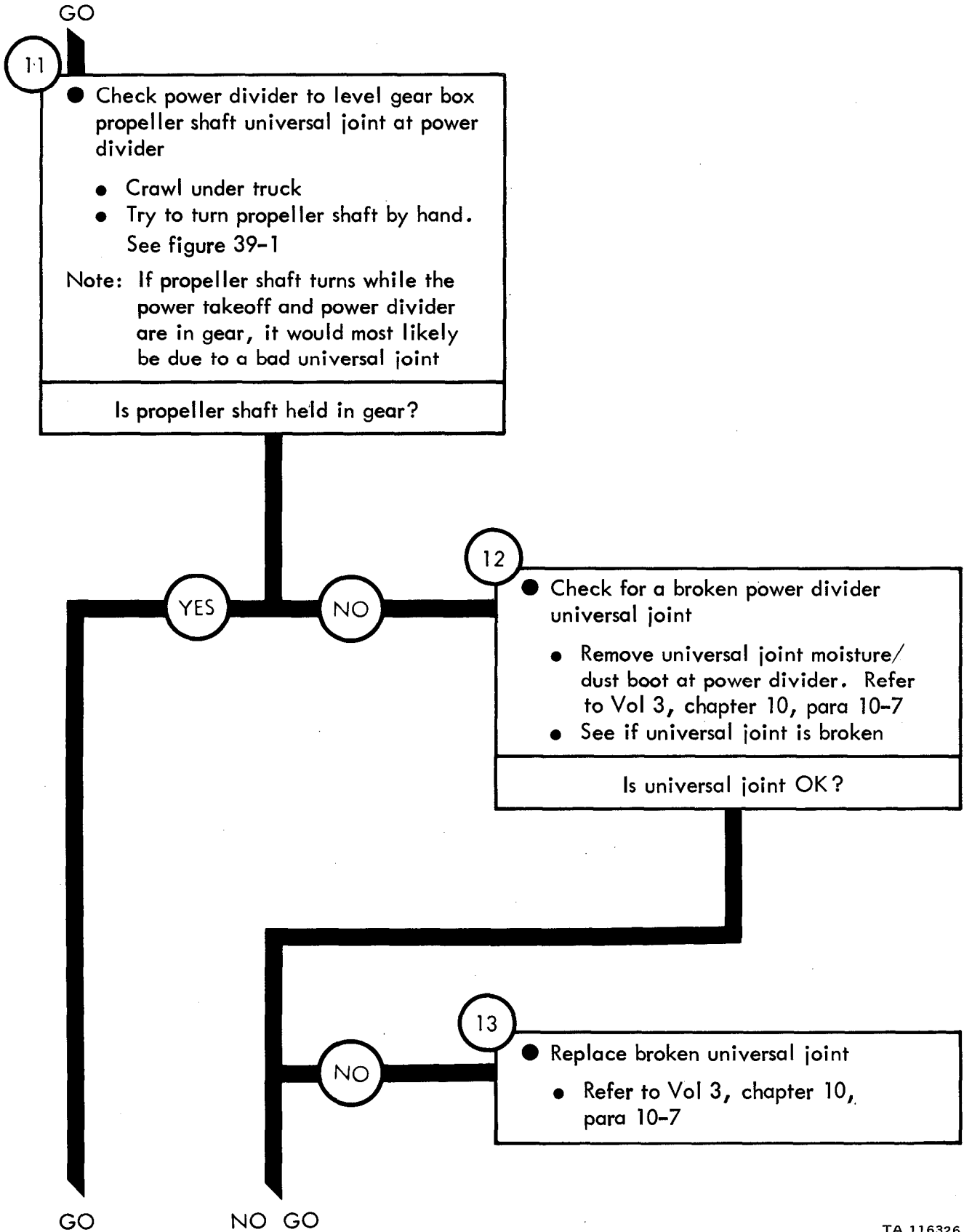

Figure 72-1 (Sheet 4 of 6)

TA 116326

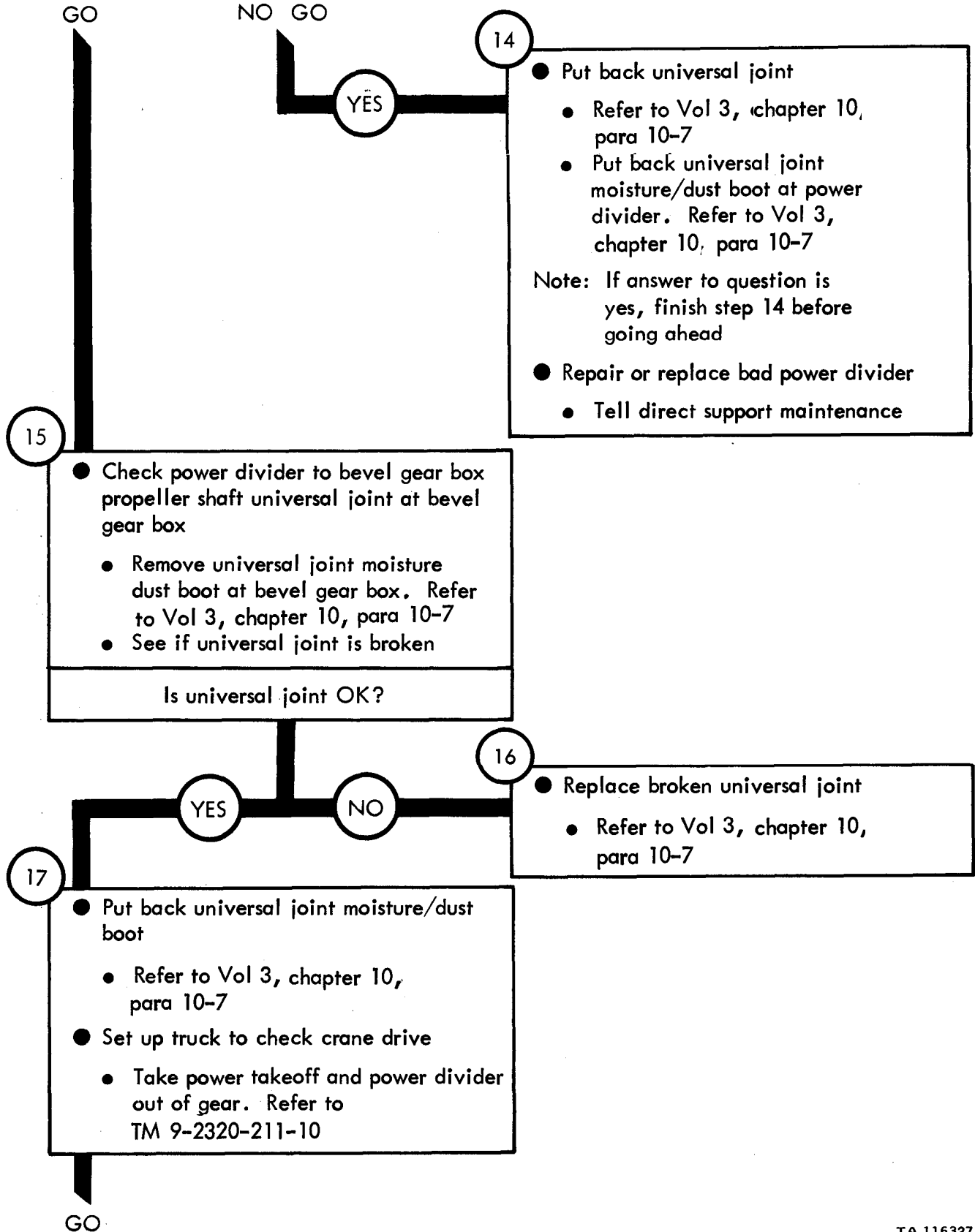

Figure 72-1 (Sheet 5 of 6)

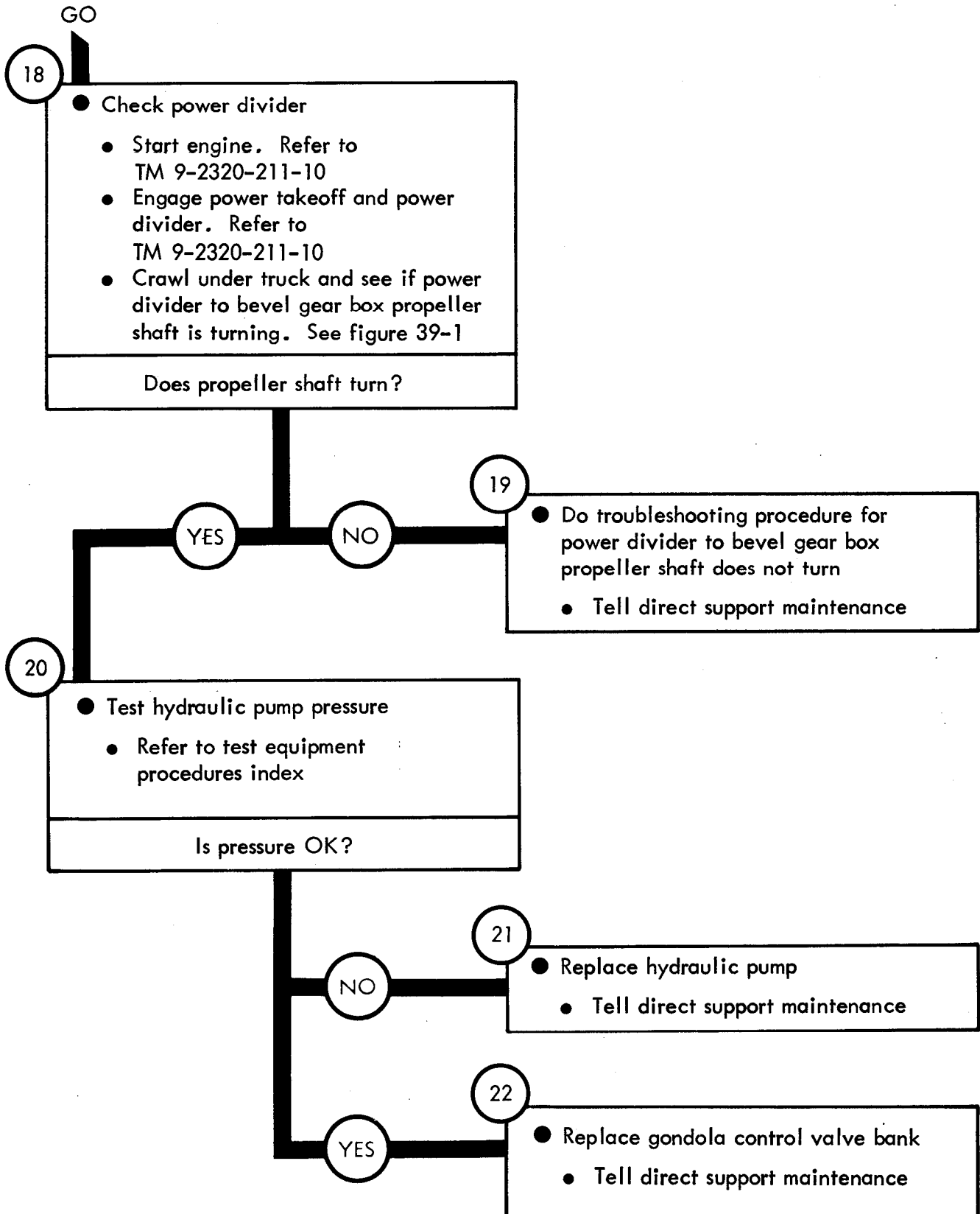

Figure 72-1 (Sheet 6 of 6)

TA 116328

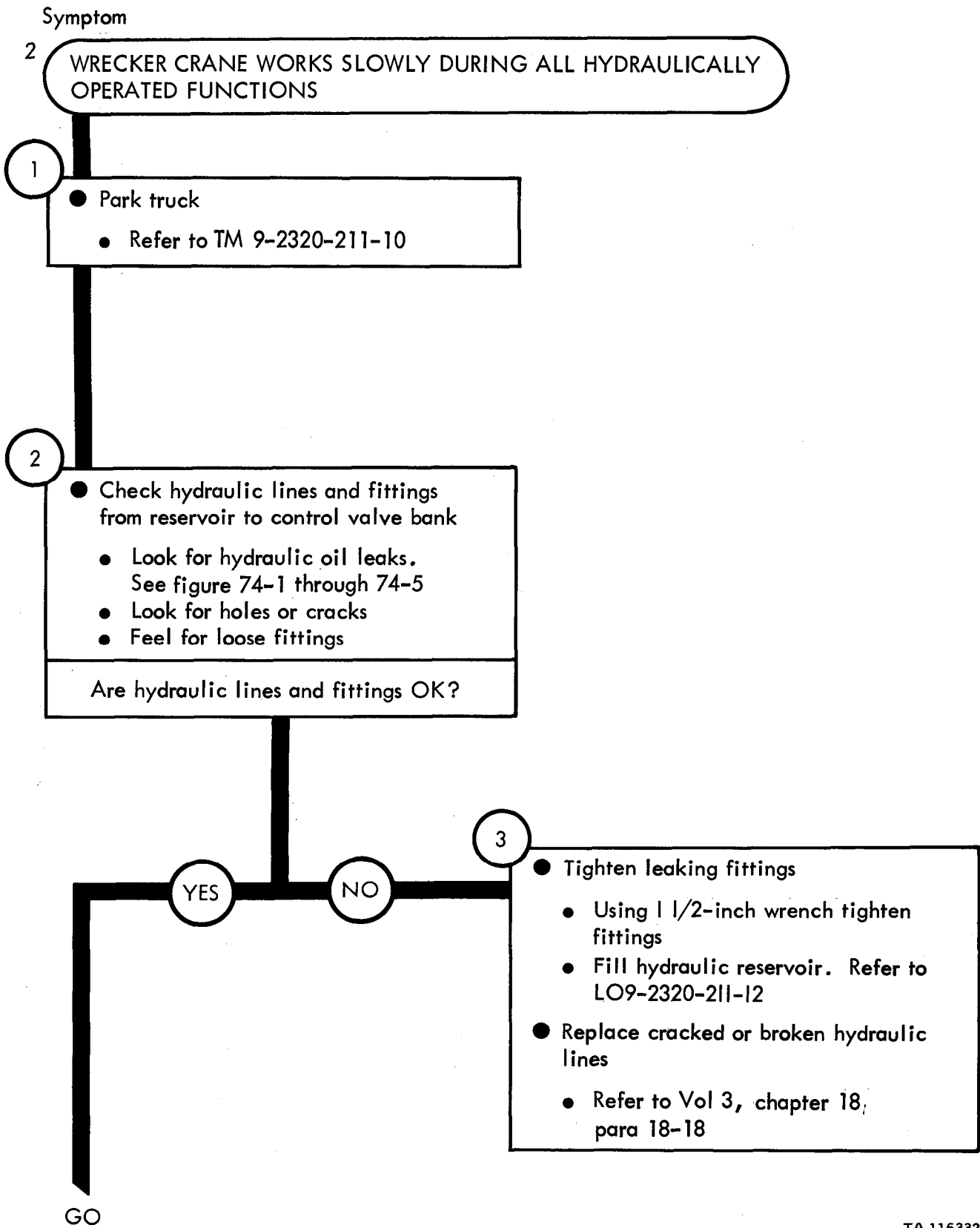

Figure 72-2 (Sheet 1 of 2)

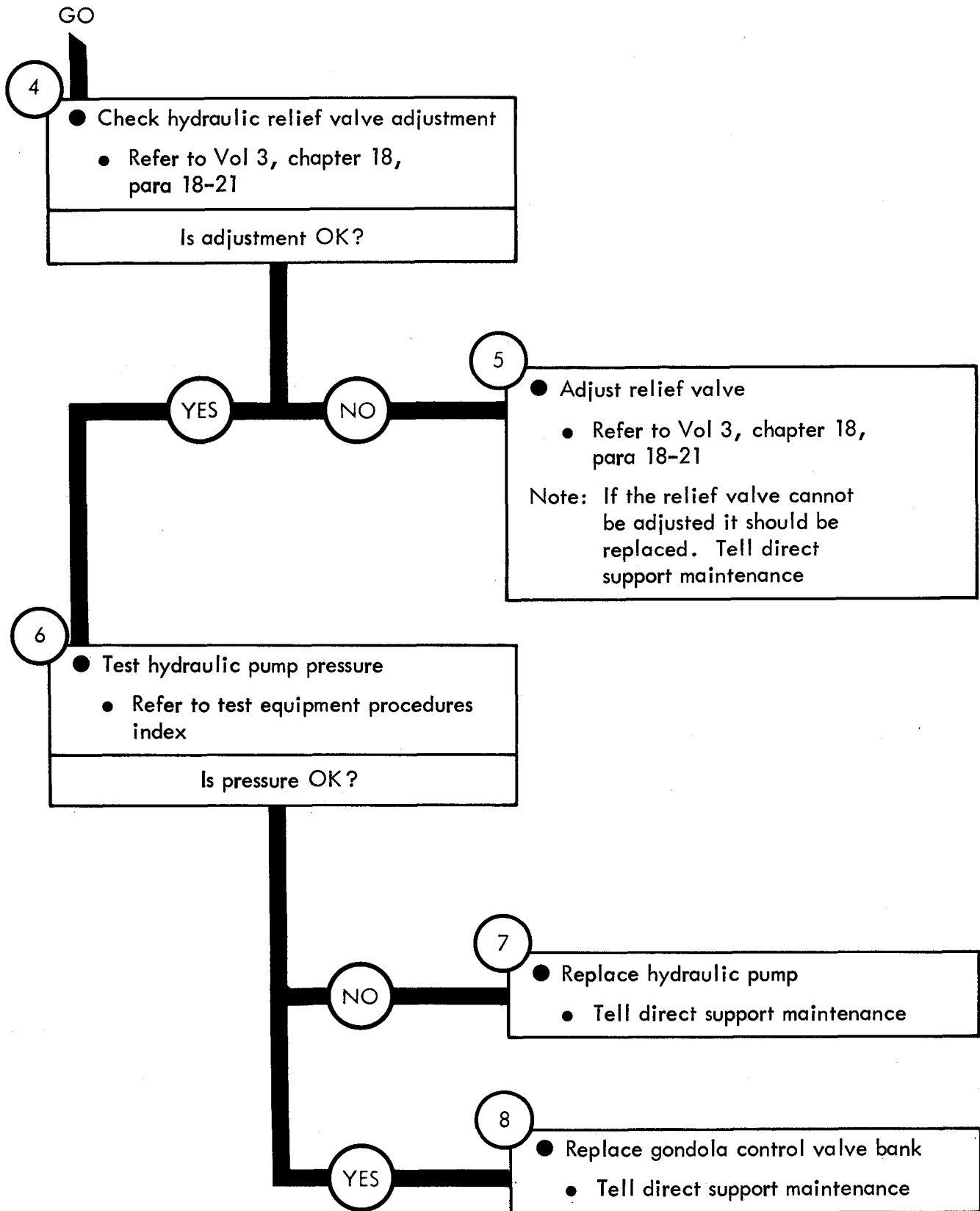

Figure 72-2 (Sheet 2 of 2)

TA 116333

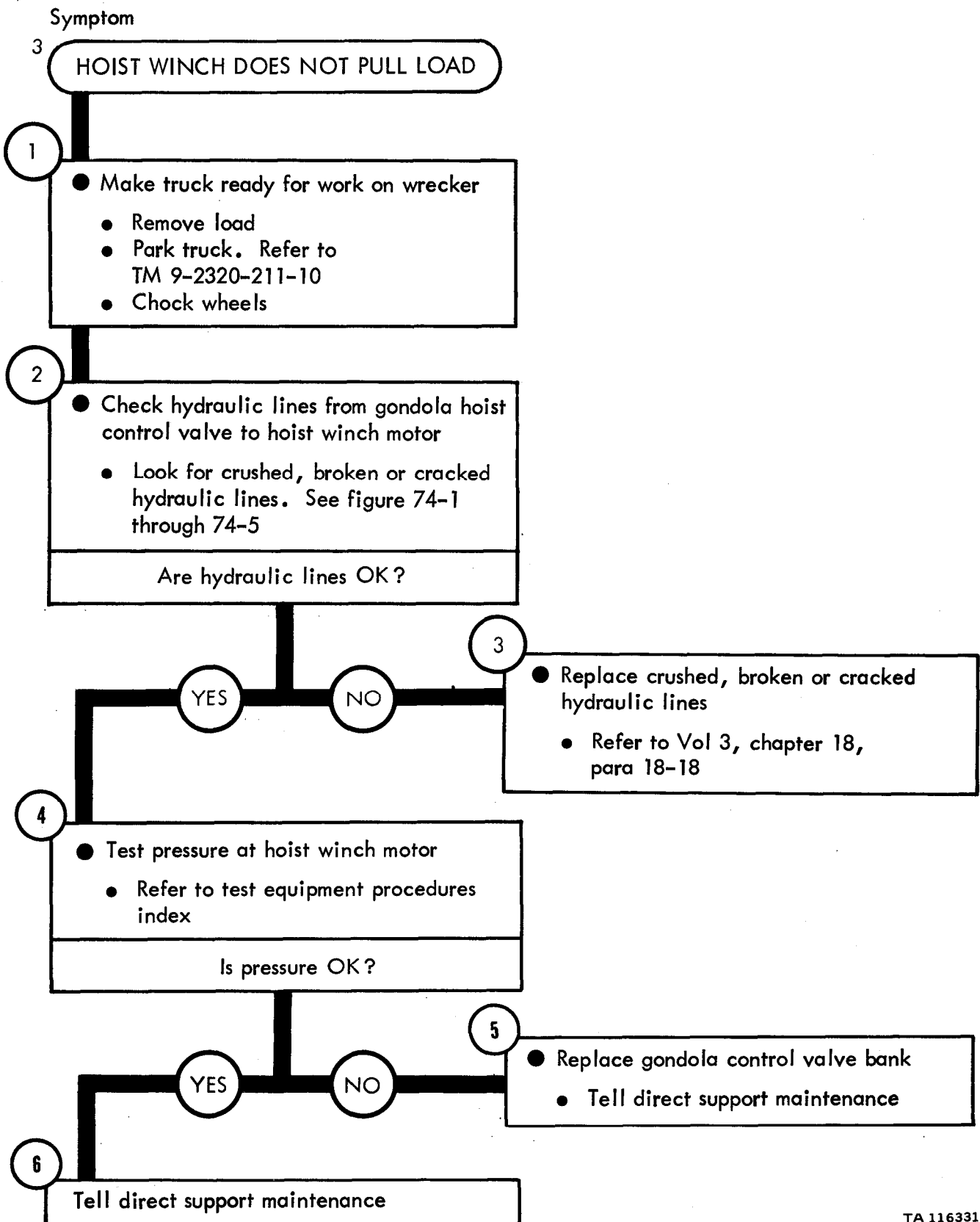

Figure 72-3

TA 116331

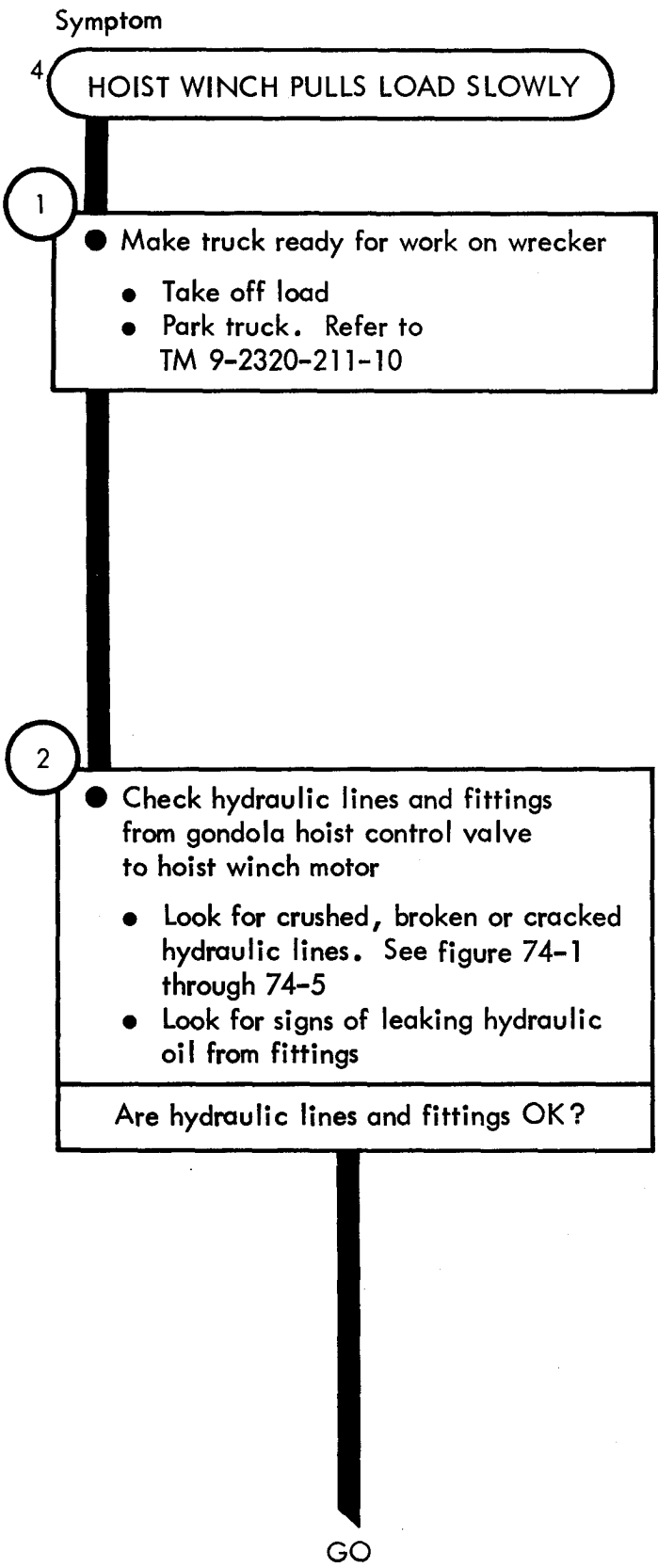

Figure 72-4 (Sheet 1 of 2)

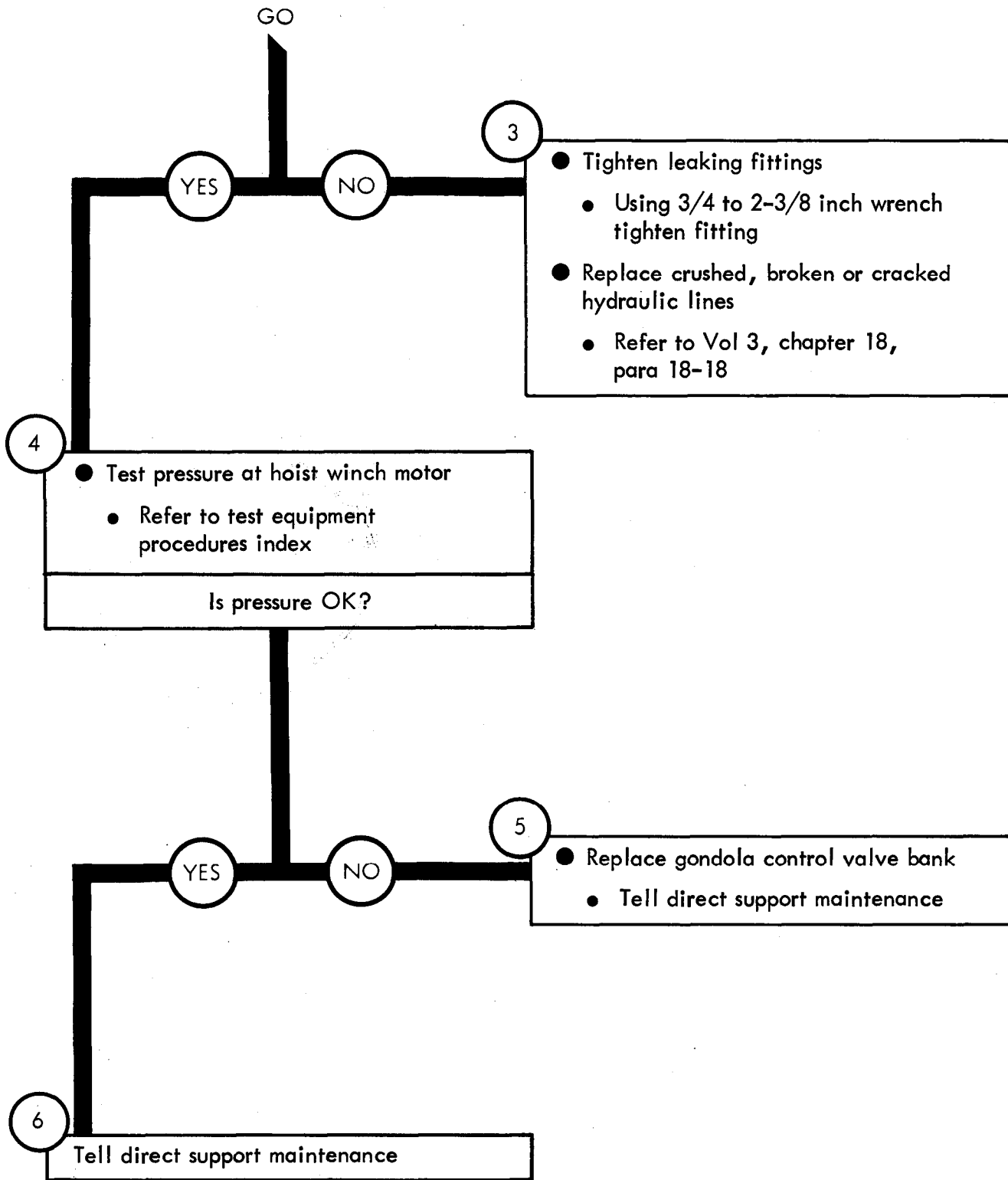

Figure 72-4 (Sheet 2 of 2)

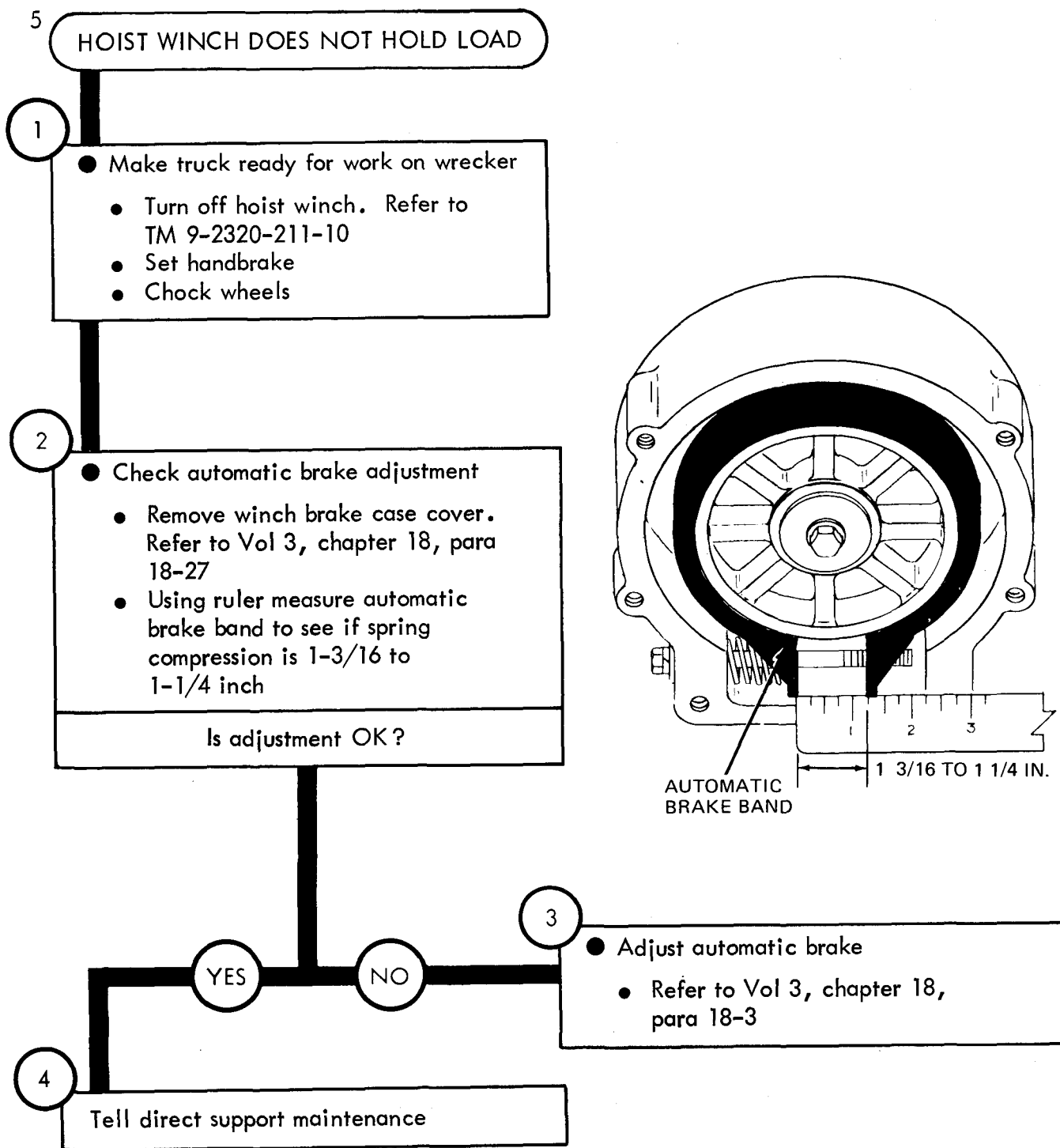

Figure 72-5

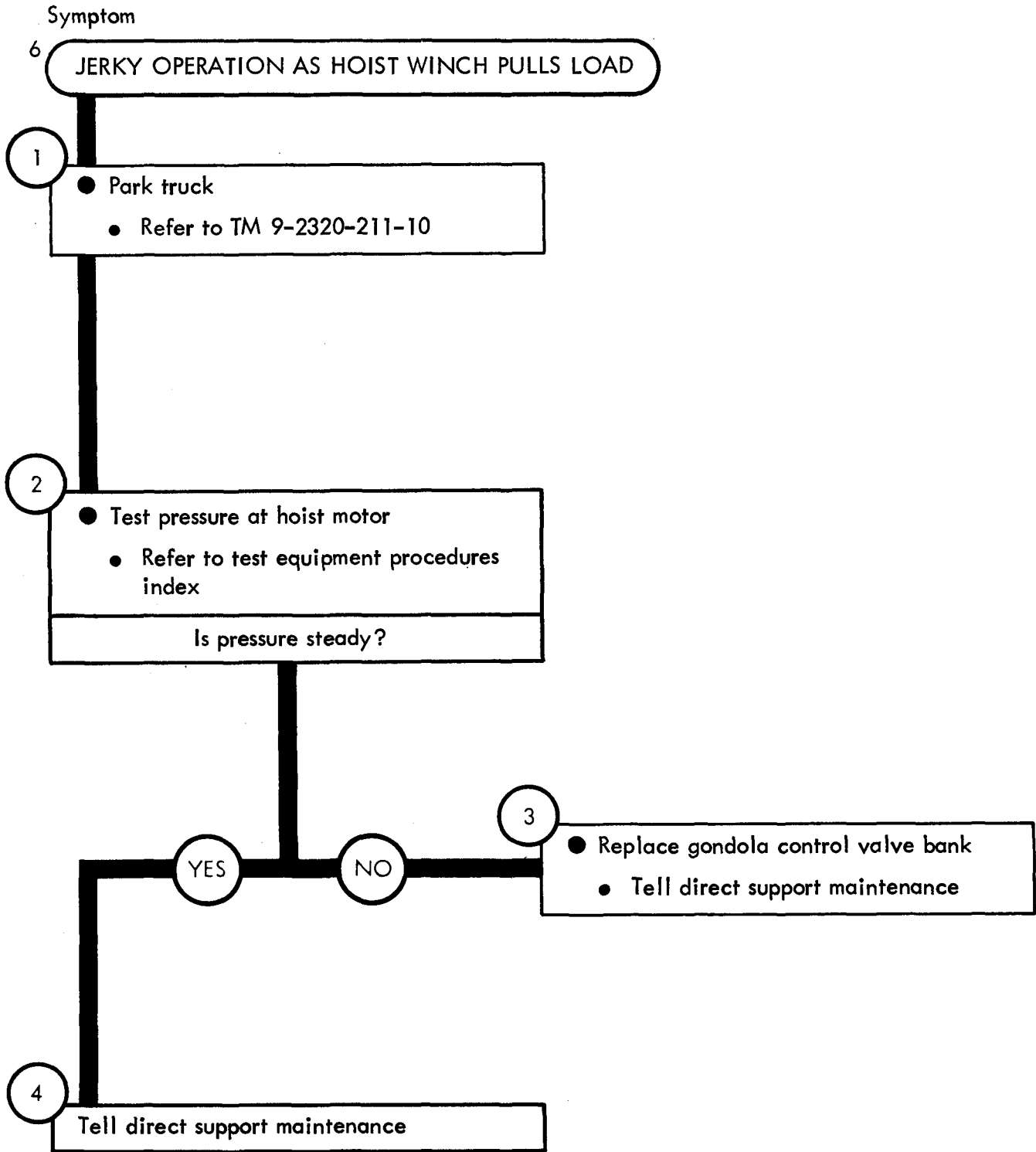

Figure 72-6

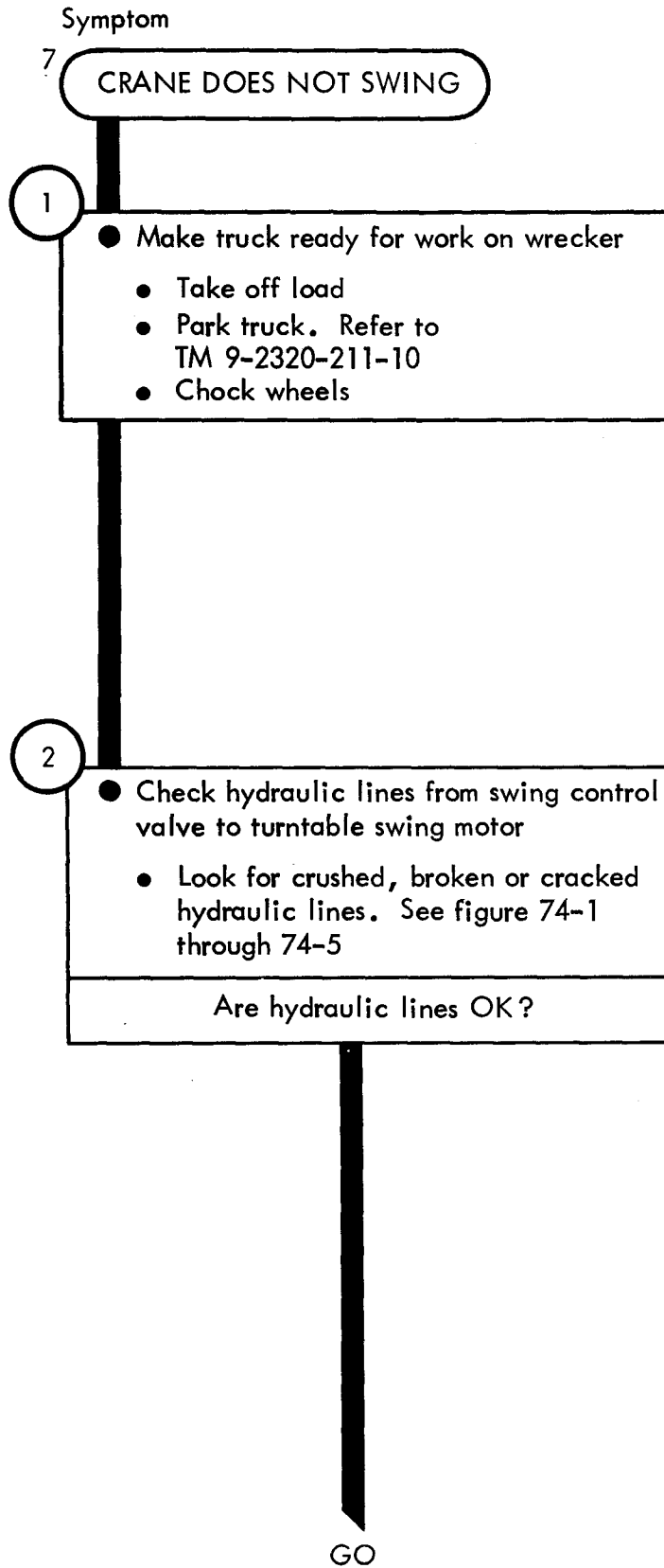

Figure 72-7 (Sheet 1 of 2)

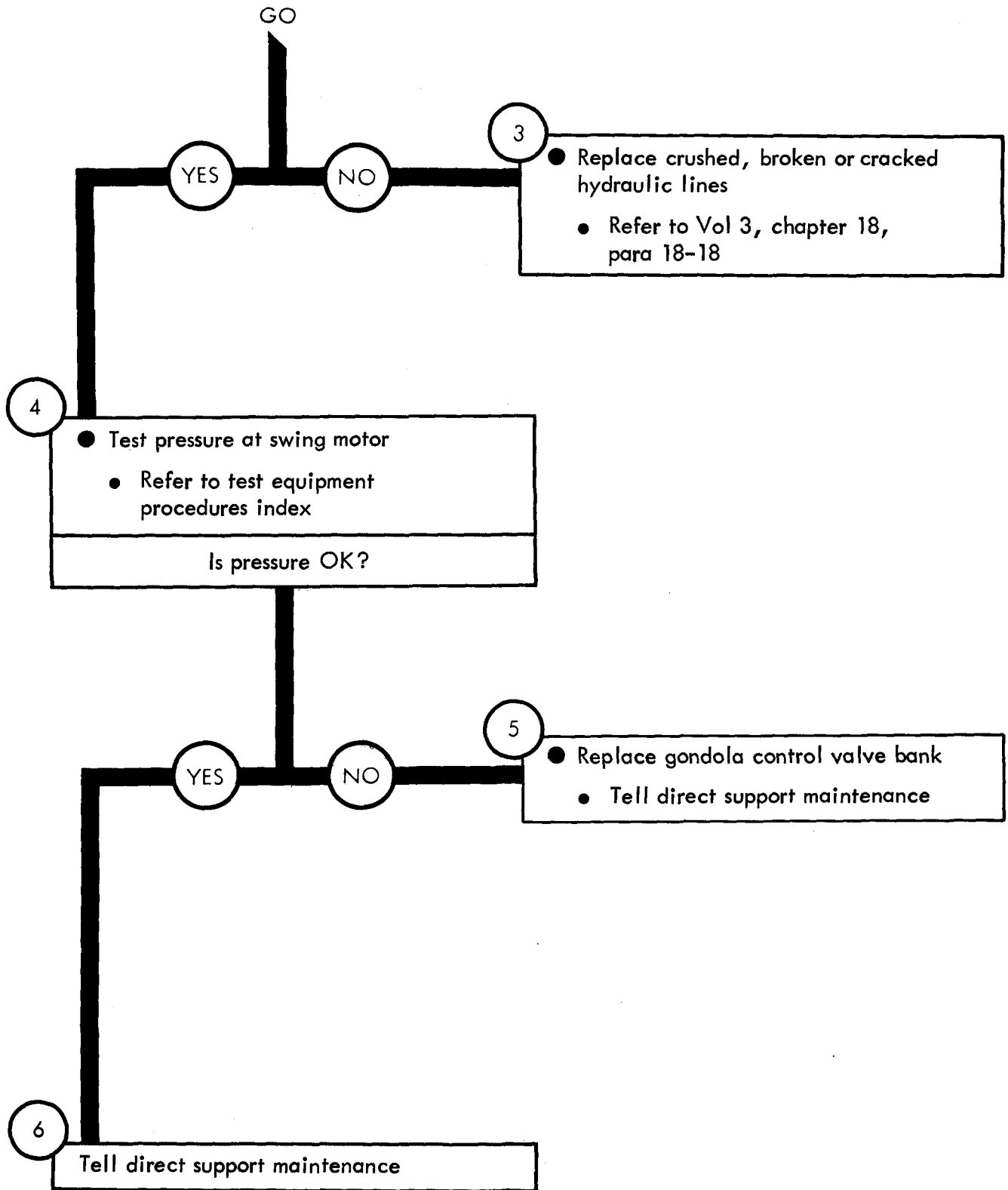

Figure 72-7 (Sheet 2 of 2)

Symptom

8

CRANE SWINGS SLOWLY

1

- Make truck ready for work on wrecker
 - Take off load
 - Park truck. Refer to TM 9-2320-211-10
 - Chock wheels

2

- Check hydraulic lines and fittings from swing control valve to turntable swing motor
 - Look for crushed, broken or cracked hydraulic lines. See figure 74-1 through 74-5
 - Look for signs of leaking hydraulic oil from fittings

Are hydraulic lines and fittings OK?

GO

Figure 72-8 (Sheet 1 of 2)

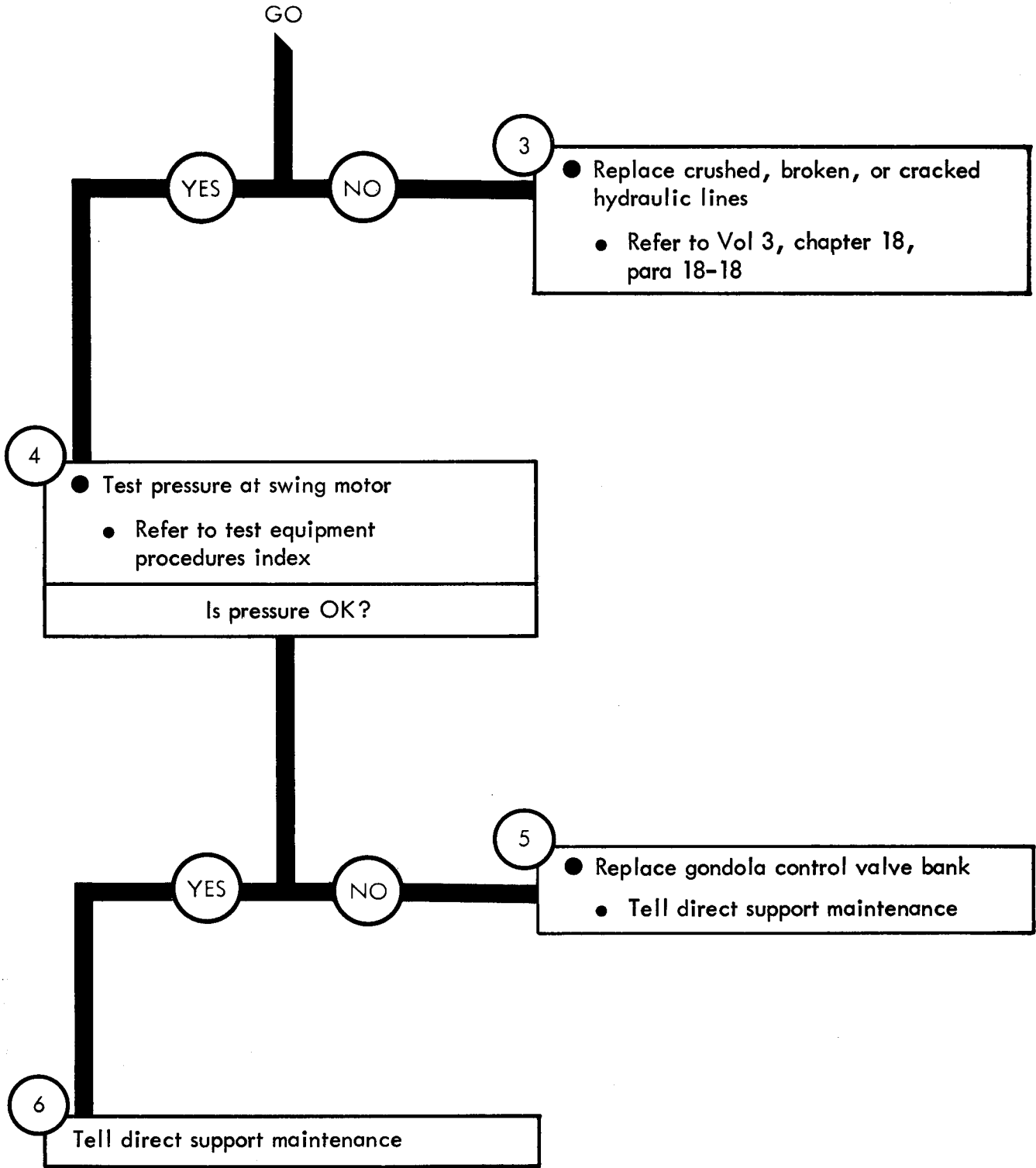

Figure 72-8 (Sheet 2 of 2)

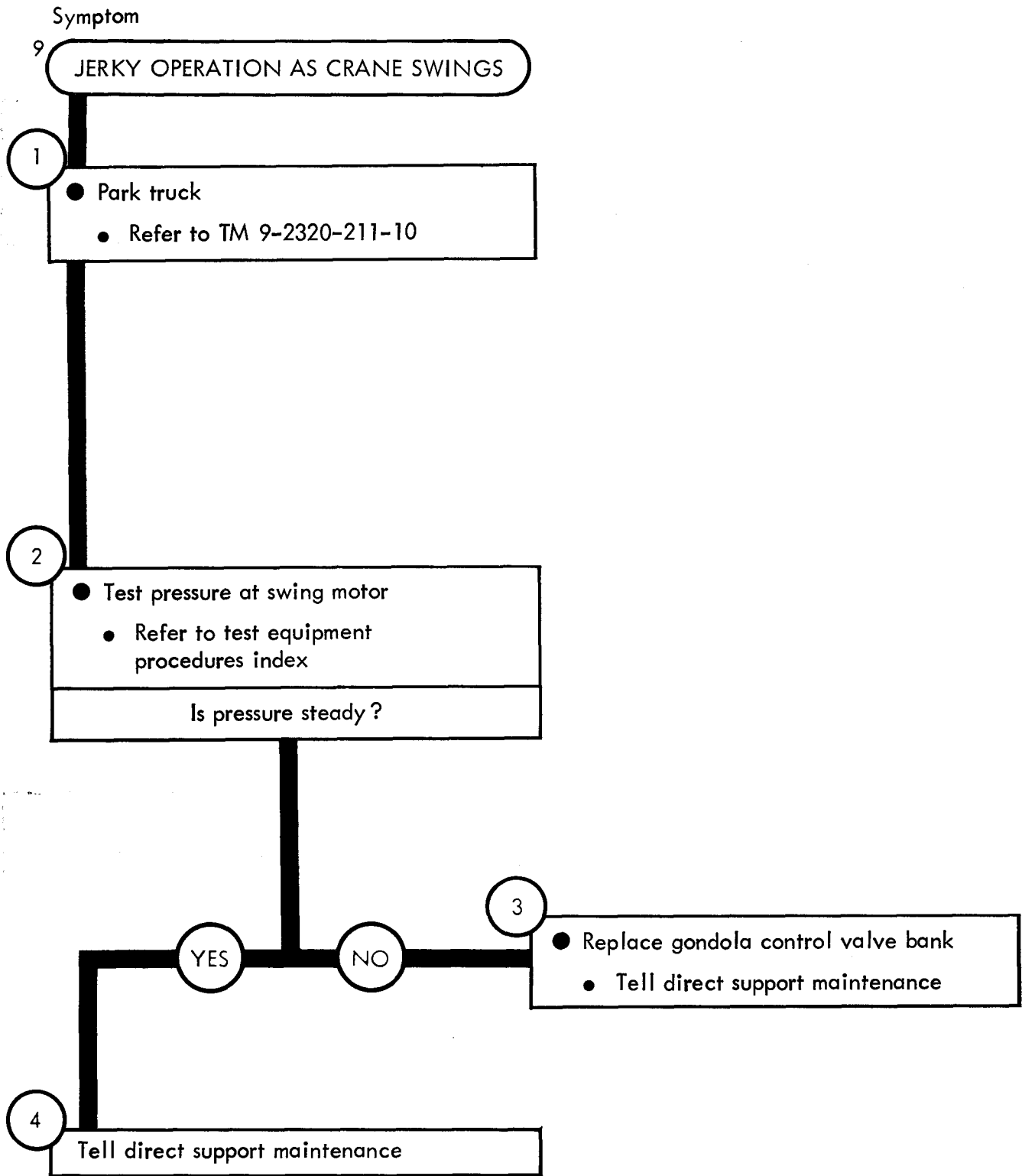

Figure 72-9

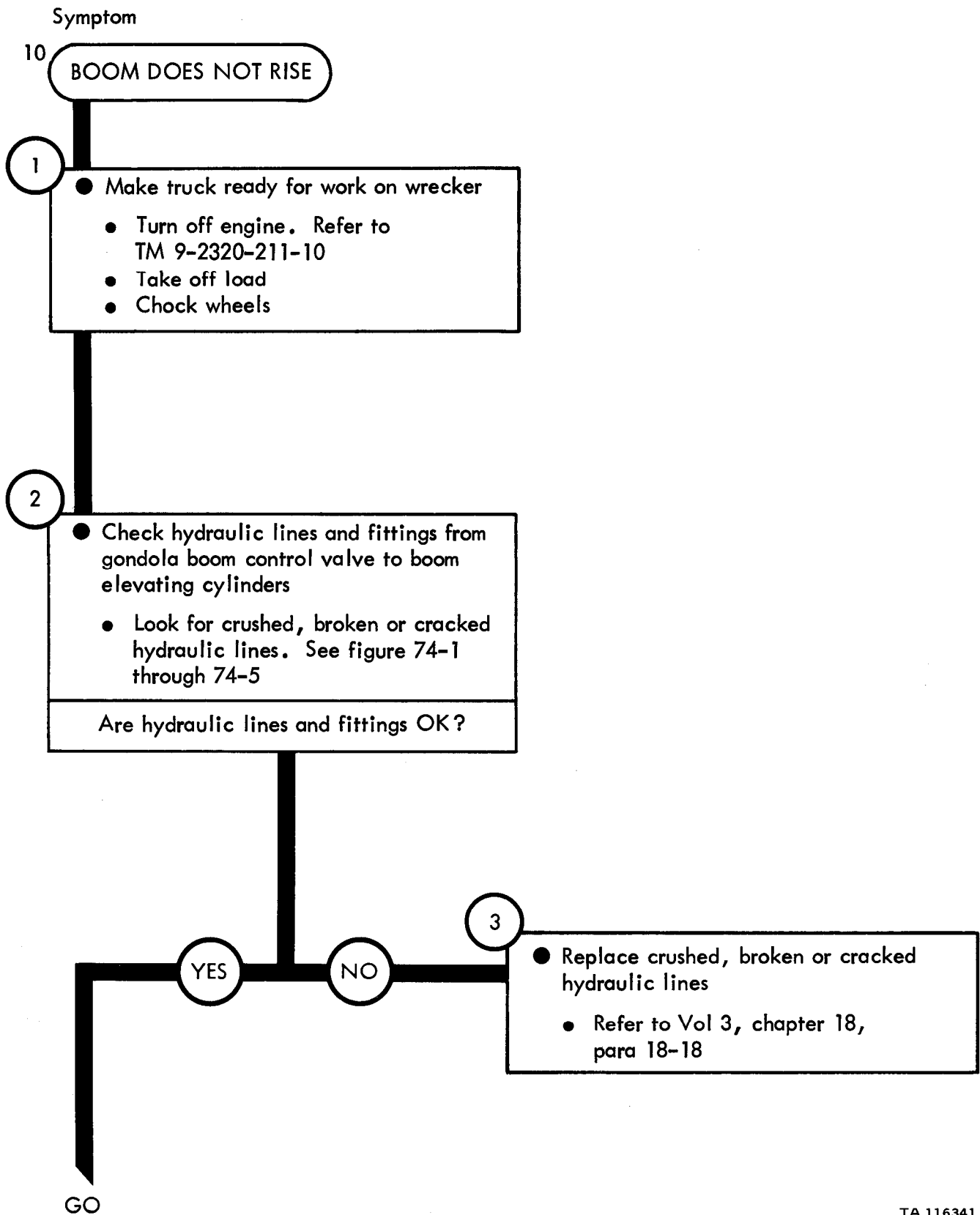

Figure 72-10 (Sheet 1 of 2)

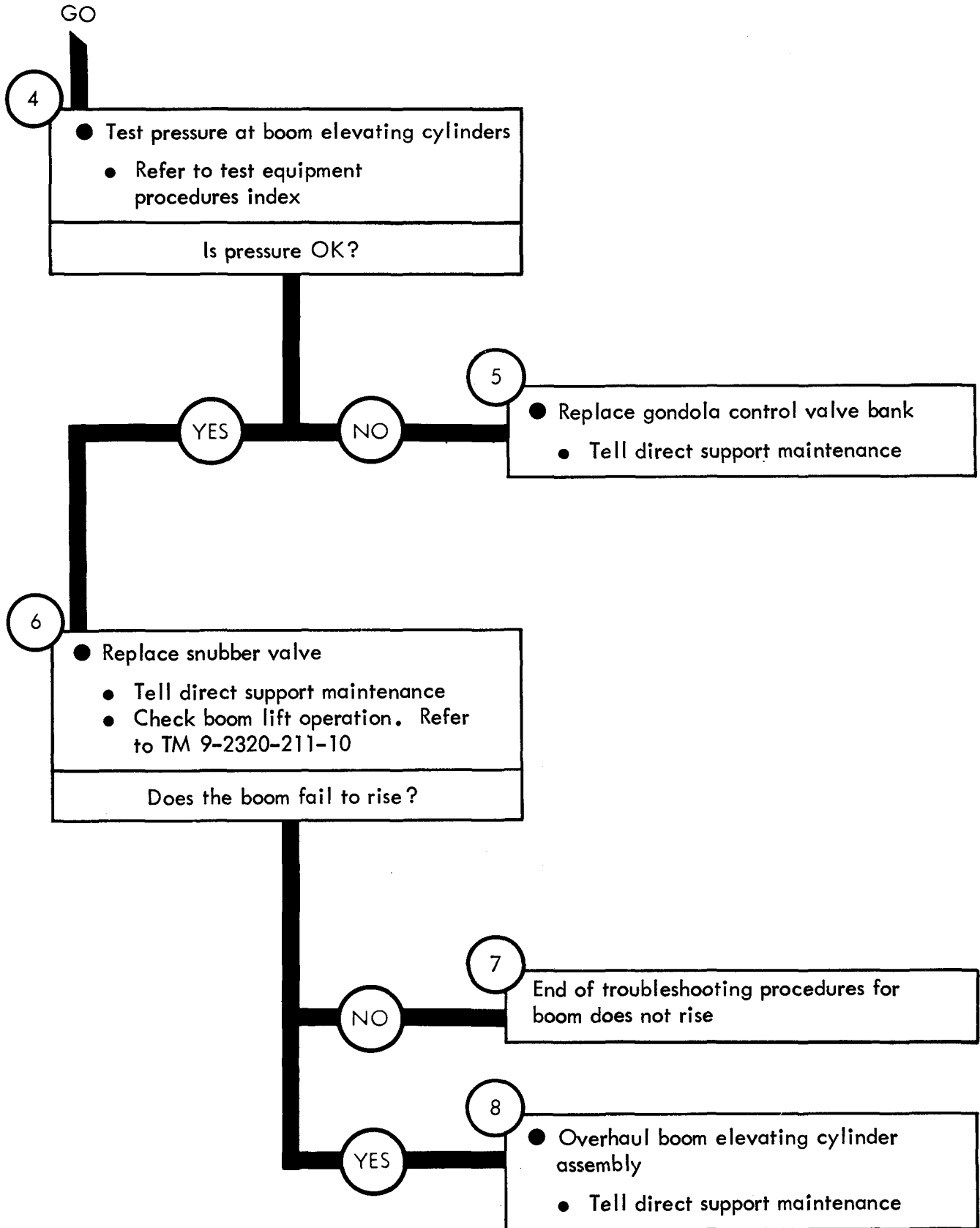
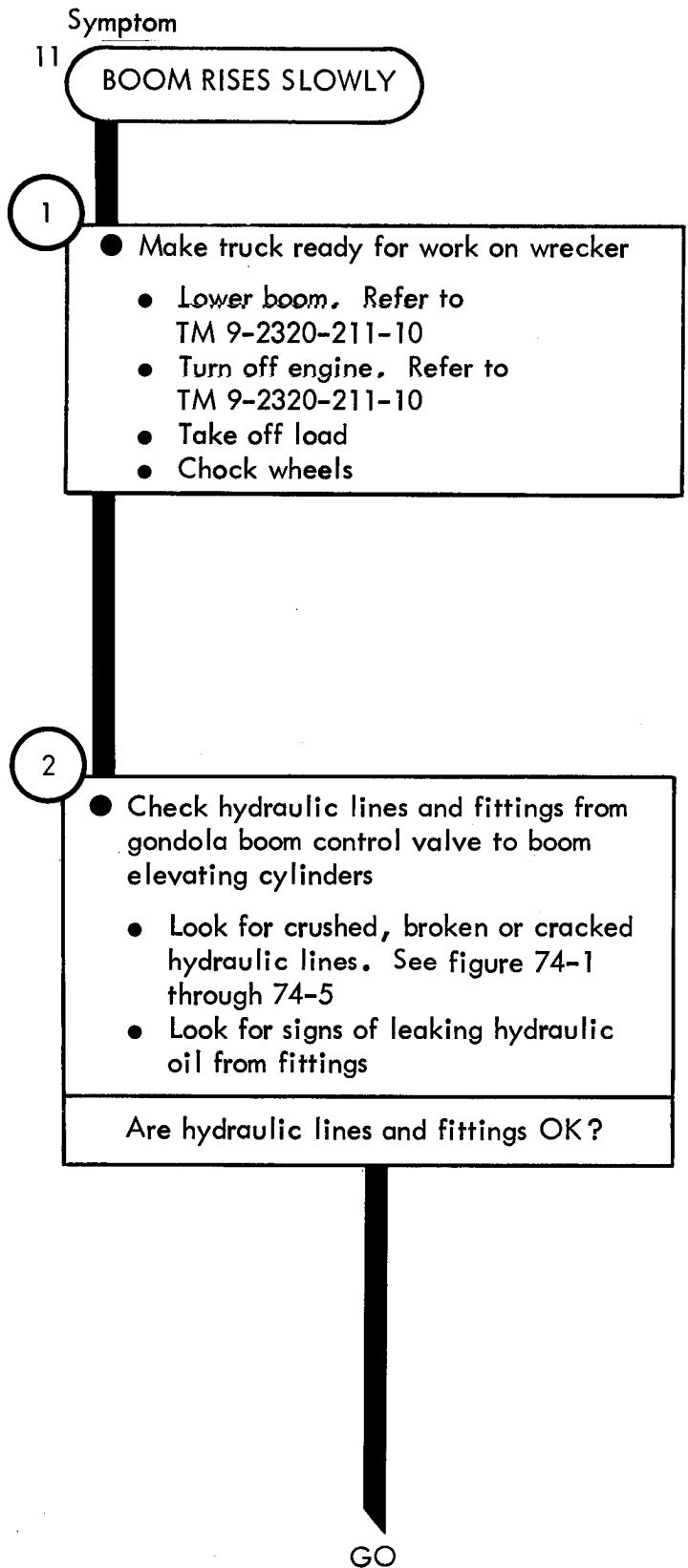

Figure 72-10 (Sheet 2 of 2)

TA 116342



GO

Figure 72-11 (Sheet 1 of 3)

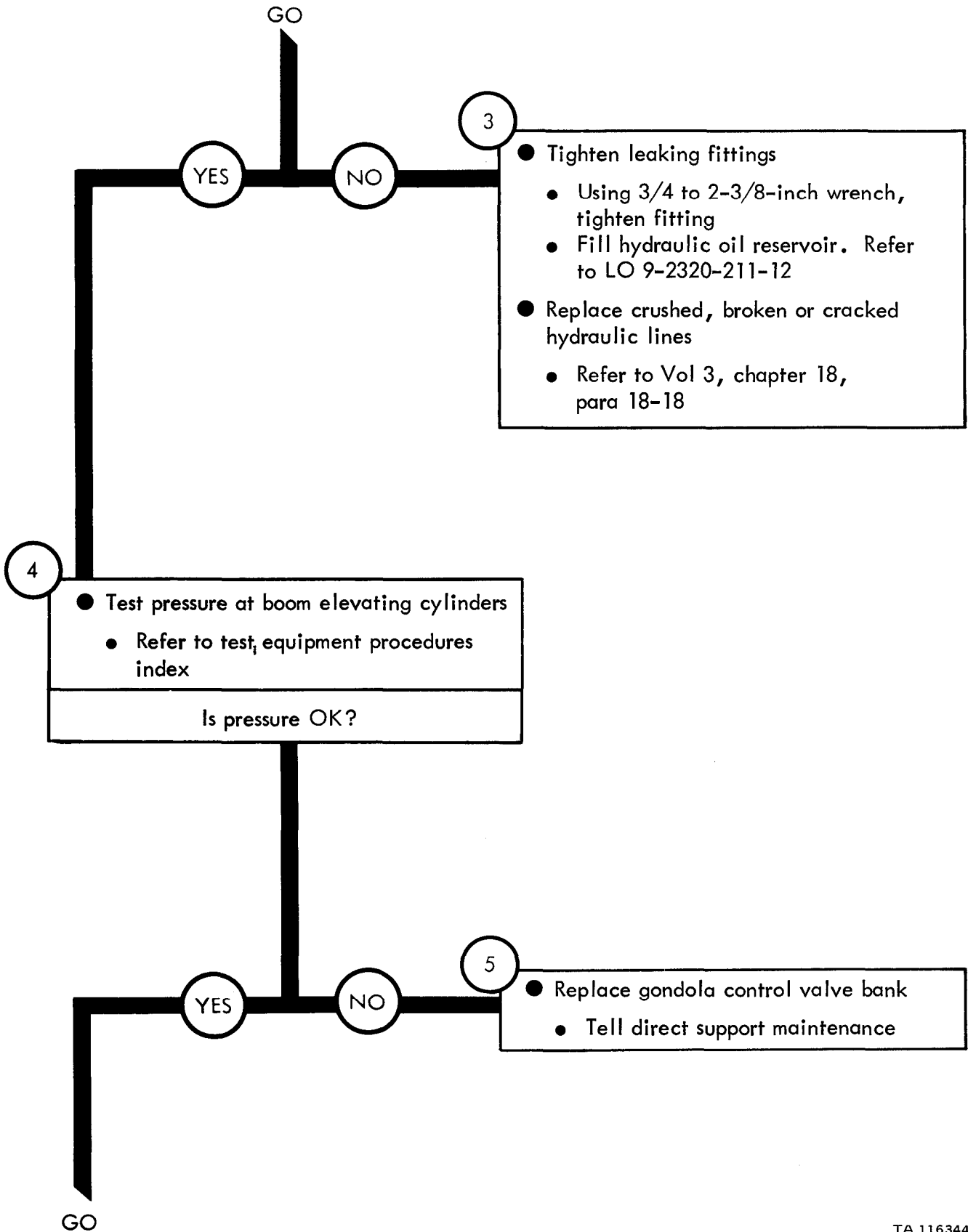

Figure 72-11 (Sheet 2 of 3)

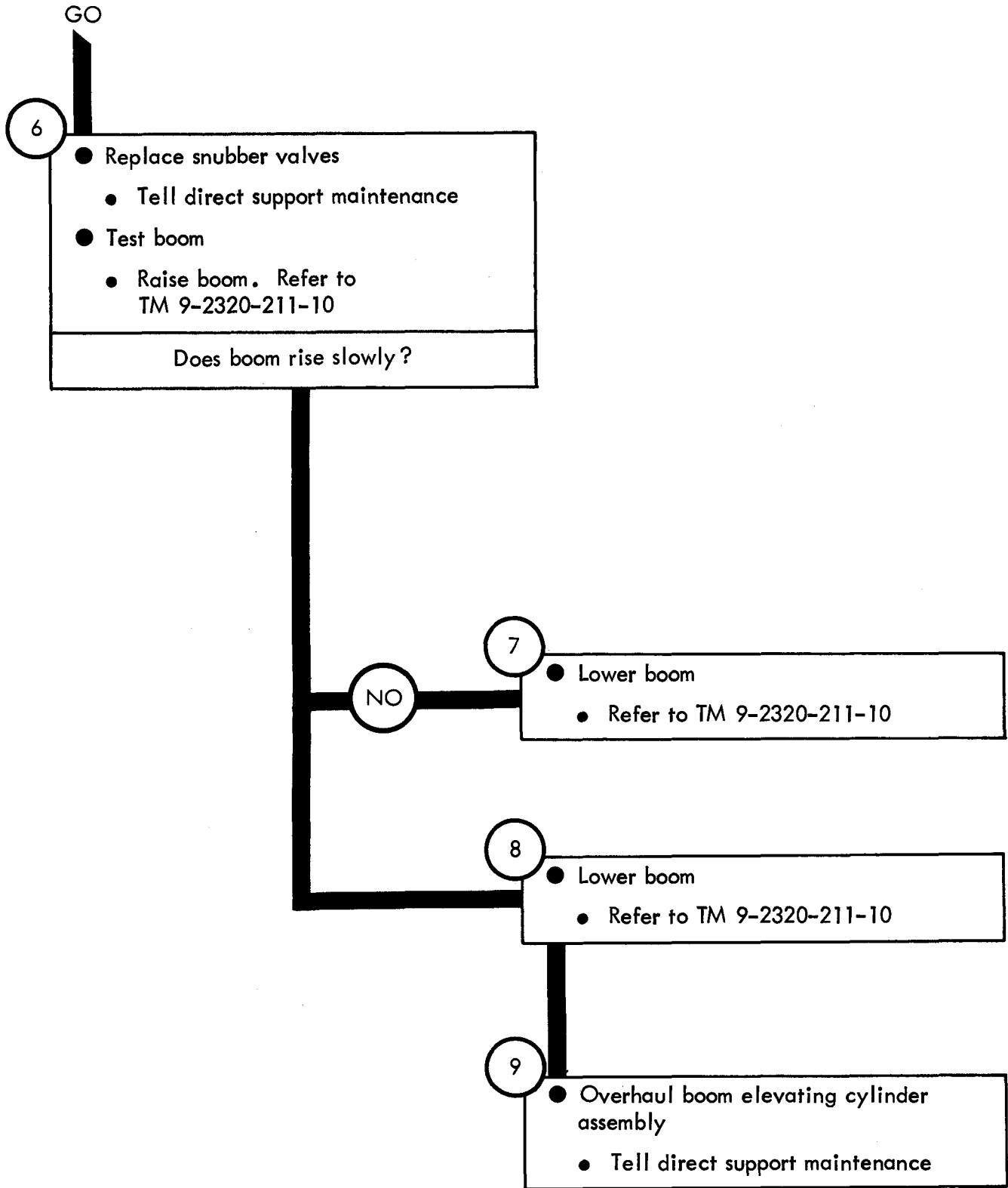
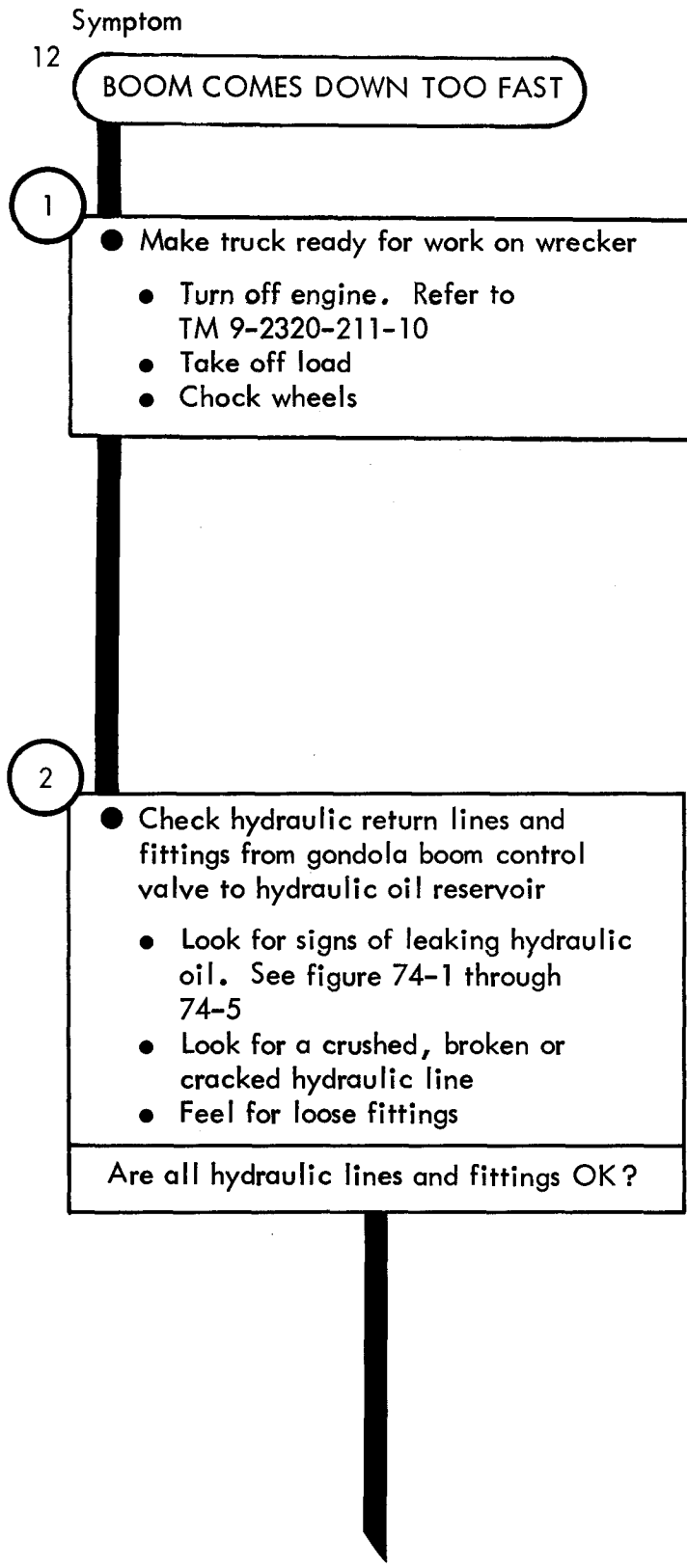

Figure 72-11 (Sheet 3 of 3)

WRECKER CRANE TROUBLESHOOTING



GO

Figure 72-12 (Sheet 1 of 2)

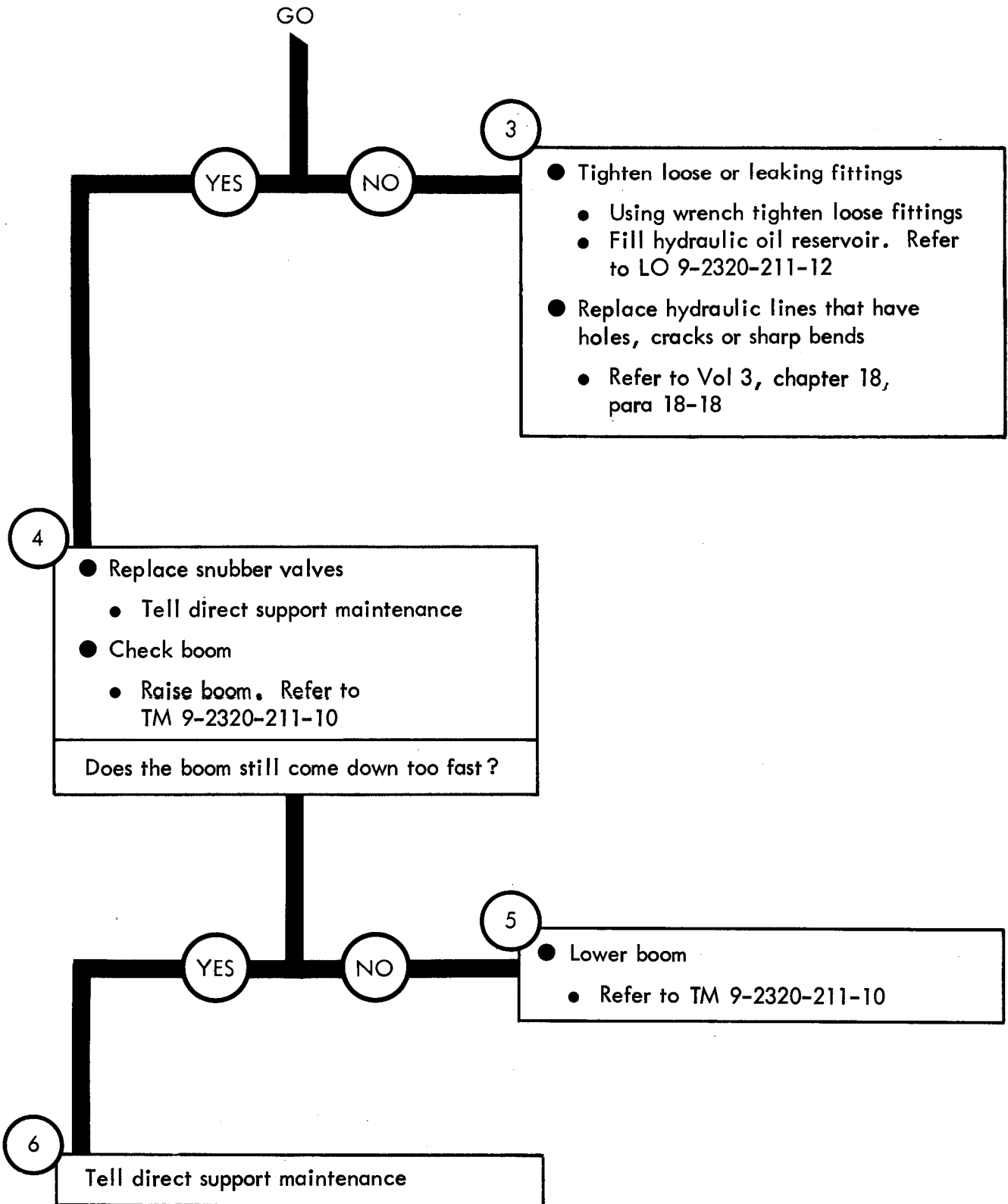

Figure 72-12 (Sheet 2 of 2)

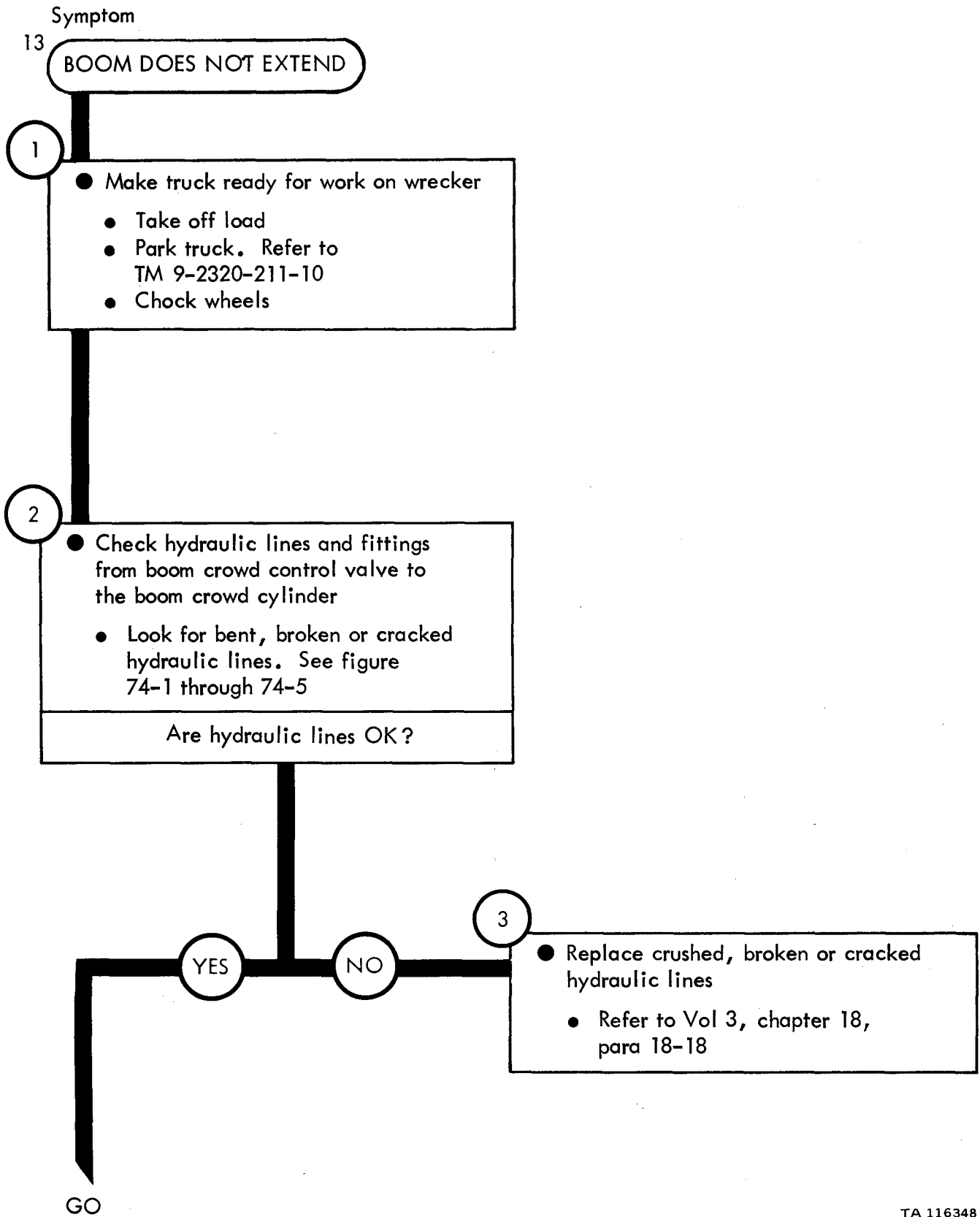

Figure 72-13 (Sheet 1 of 2)

TA 116348

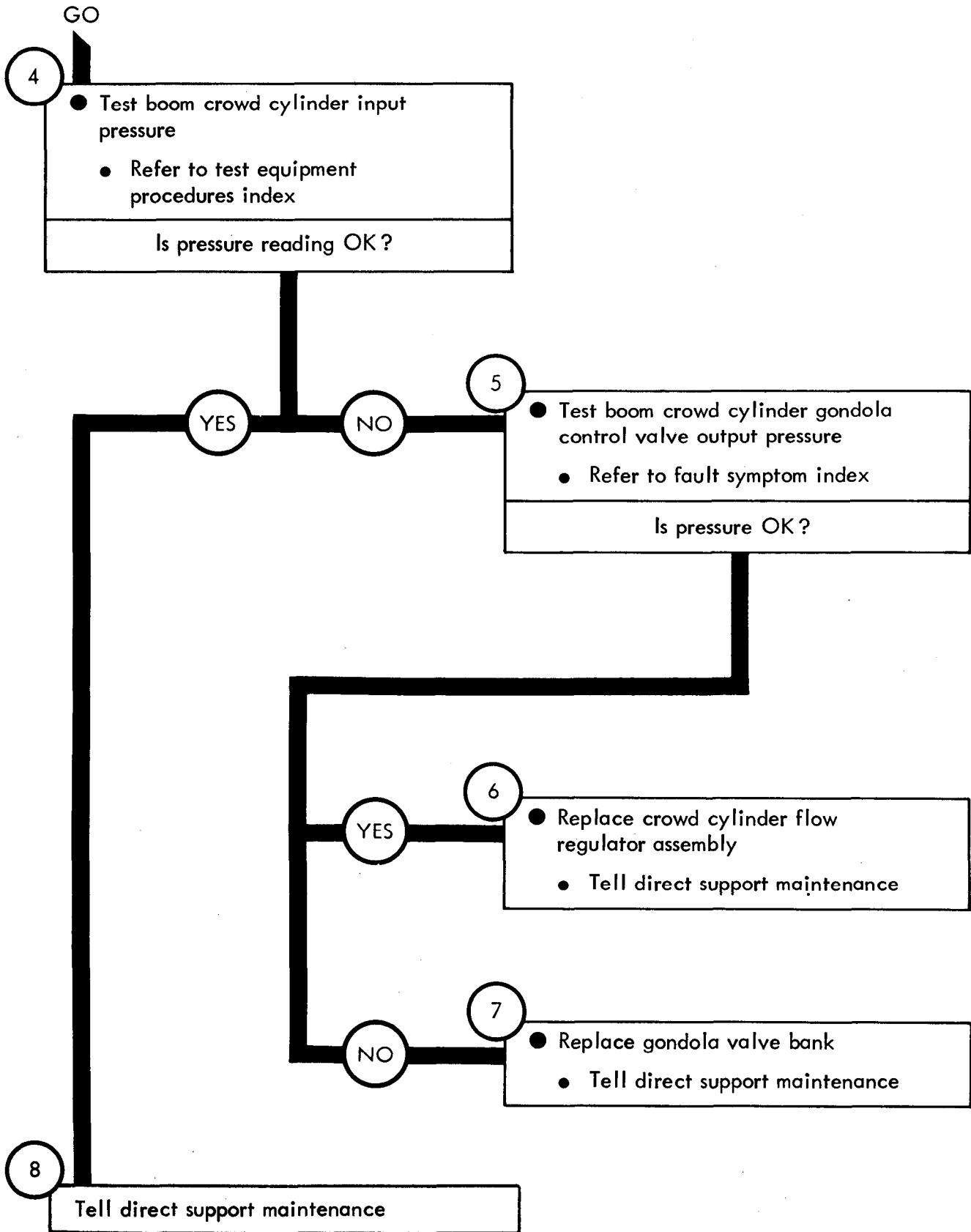

Figure 72-13 (Sheet 2 of 2)

Symptom

14

BOOM EXTENDS OR RETRACTS SLOWLY

1

- Make truck ready for work on wrecker
 - Take off load
 - Retract boom. Refer to TM 9-2320-211-10
 - Park truck. Refer to TM 9-2320-211-10
 - Chock wheels

2

- Check hydraulic lines and fittings from gondola crowd control valve to boom extension cylinder
 - Look for crushed, broken or cracked hydraulic lines. See figure 74-1 through 74-5
 - Look for signs of leaking hydraulic oil from fittings

Are hydraulic lines and fittings OK?

GO

Figure 72-14 (Sheet 1 of 3)

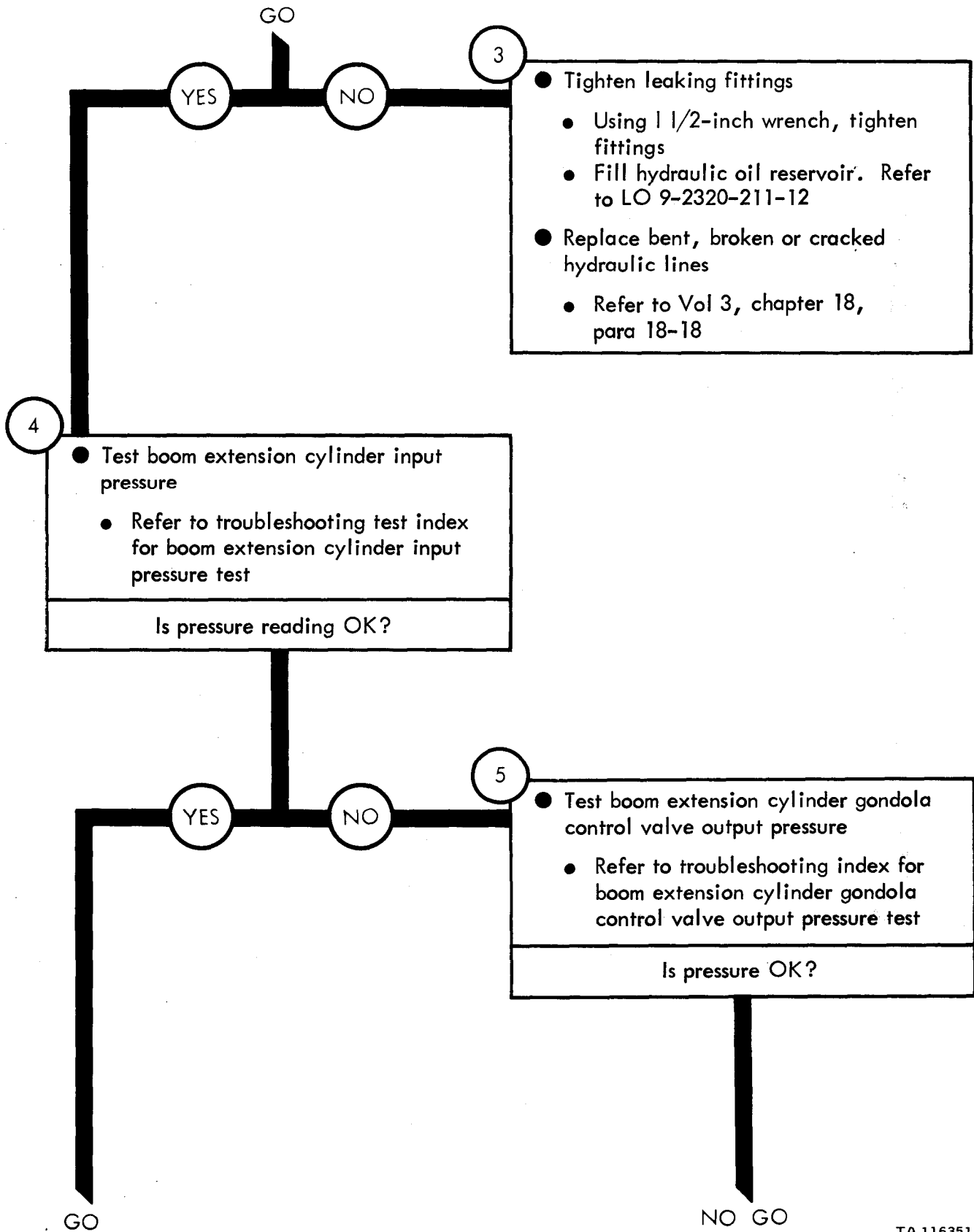

Figure 72-14 (Sheet 2 of 3)

TA 116351

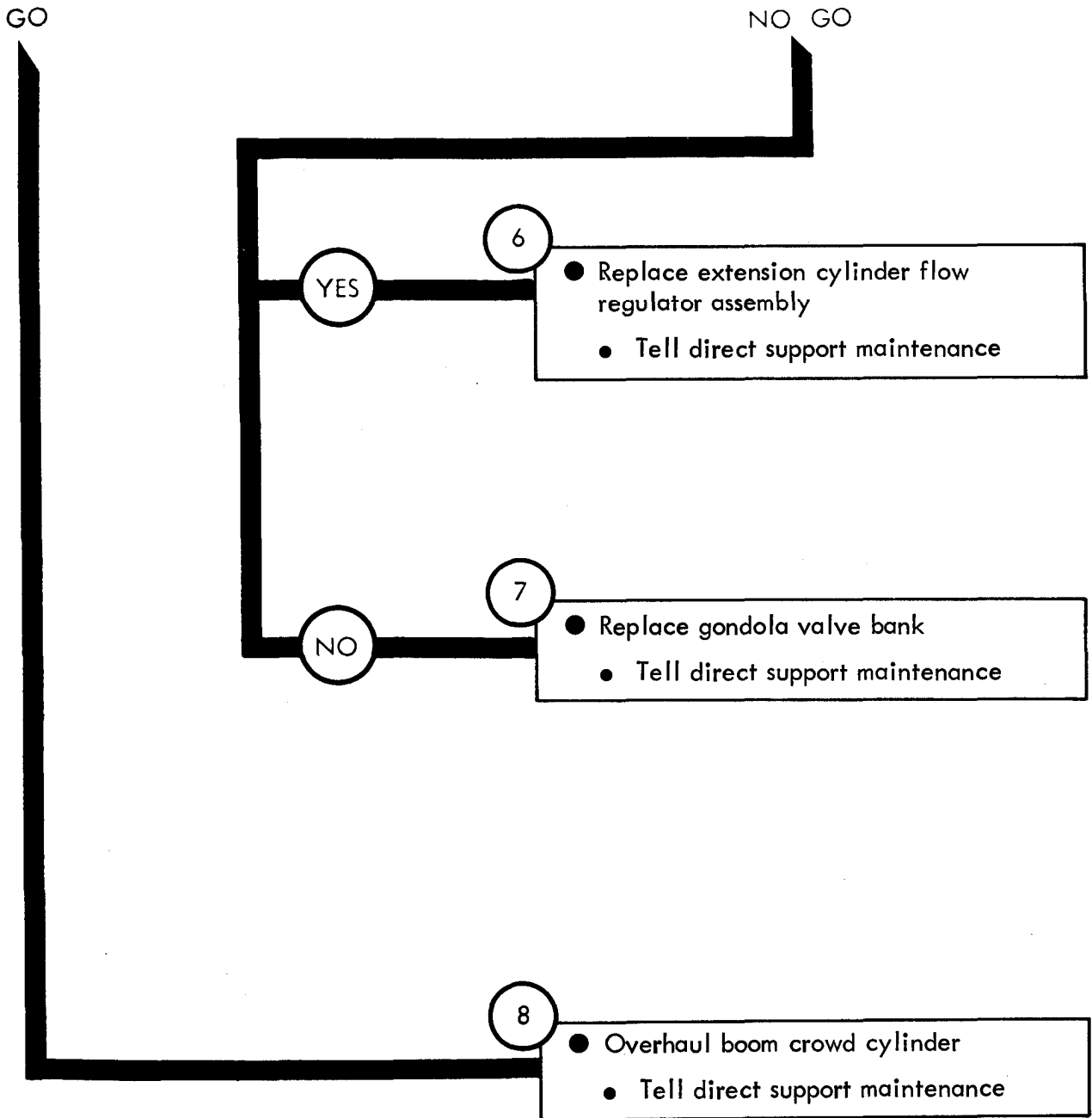

Figure 72-14 (Sheet 3 of 3)

Symptom

15

JERKY OPERATION AS BOOM EXTENDS OR RETRACTS

1

- Make truck ready for work on wrecker
 - Take off load
 - Retract boom
 - Park truck. Refer to TM 9-2320-211-10

2

- Test boom extension cylinder input pressure
 - Refer to test equipment procedures index

Is pressure reading steady?

GO

Figure 72-15 (Sheet 1 of 2)

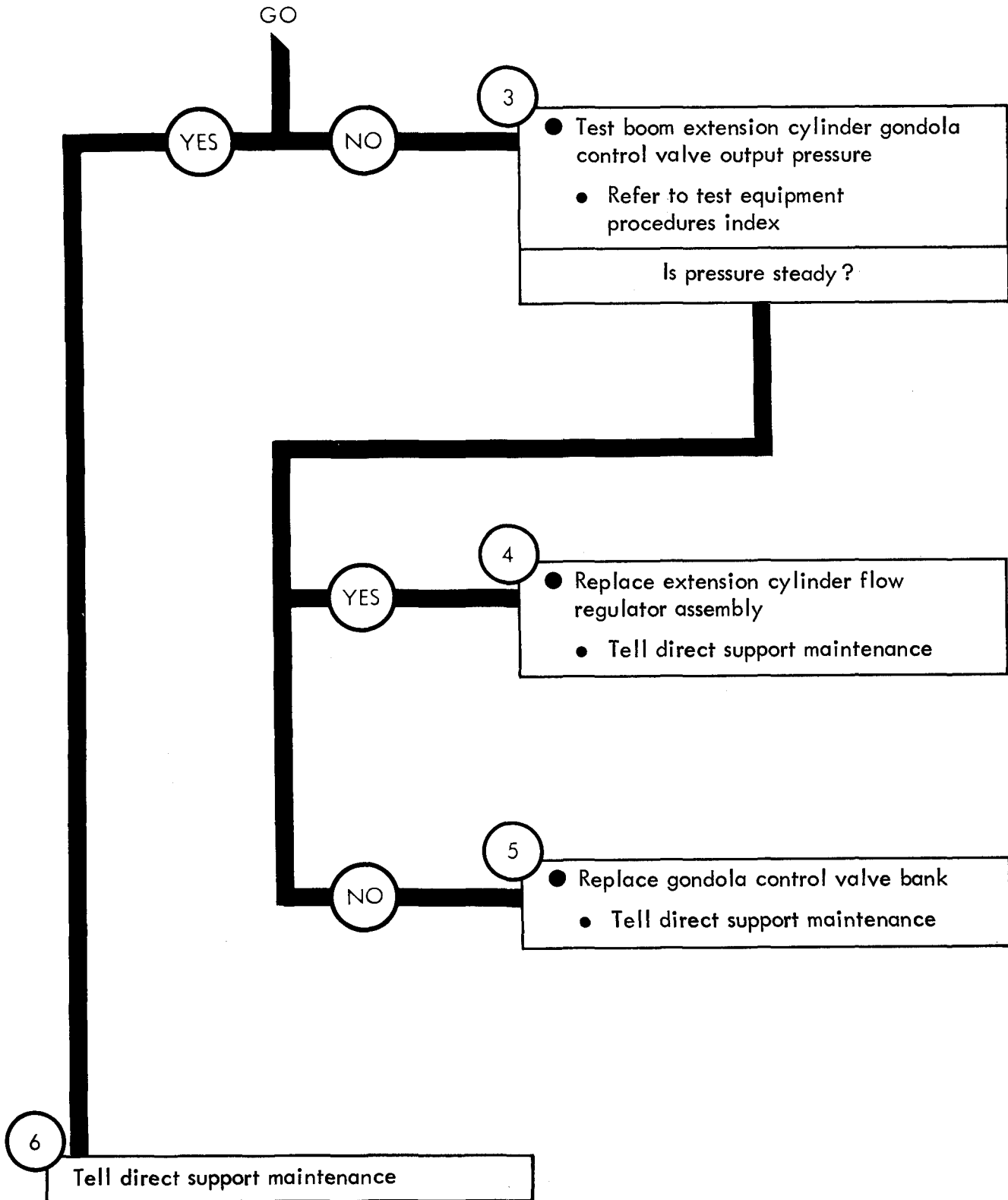

Figure 72-15 (Sheet 2 of 2)

Symptom

16

WINCH DRIVE CONTROL LEVER DOES NOT GO INTO GEAR OR GRINDS WHEN GOING INTO GEAR

1

- Make truck ready for work on wrecker
 - Move clutch control lever to DISENGAGE
 - Move winch shift lever to NEUTRAL
 - Park truck. Refer to TM 9-2320-211-10

2

- Check winch drive control linkage
 - Crawl under truck
 - Look for broken linkage. See figure 70-2
 - Look for bent linkage
 - Shake linkage to feel if it is loose

Is control linkage OK?



GO

Figure 72-16 (Sheet 1 of 2)

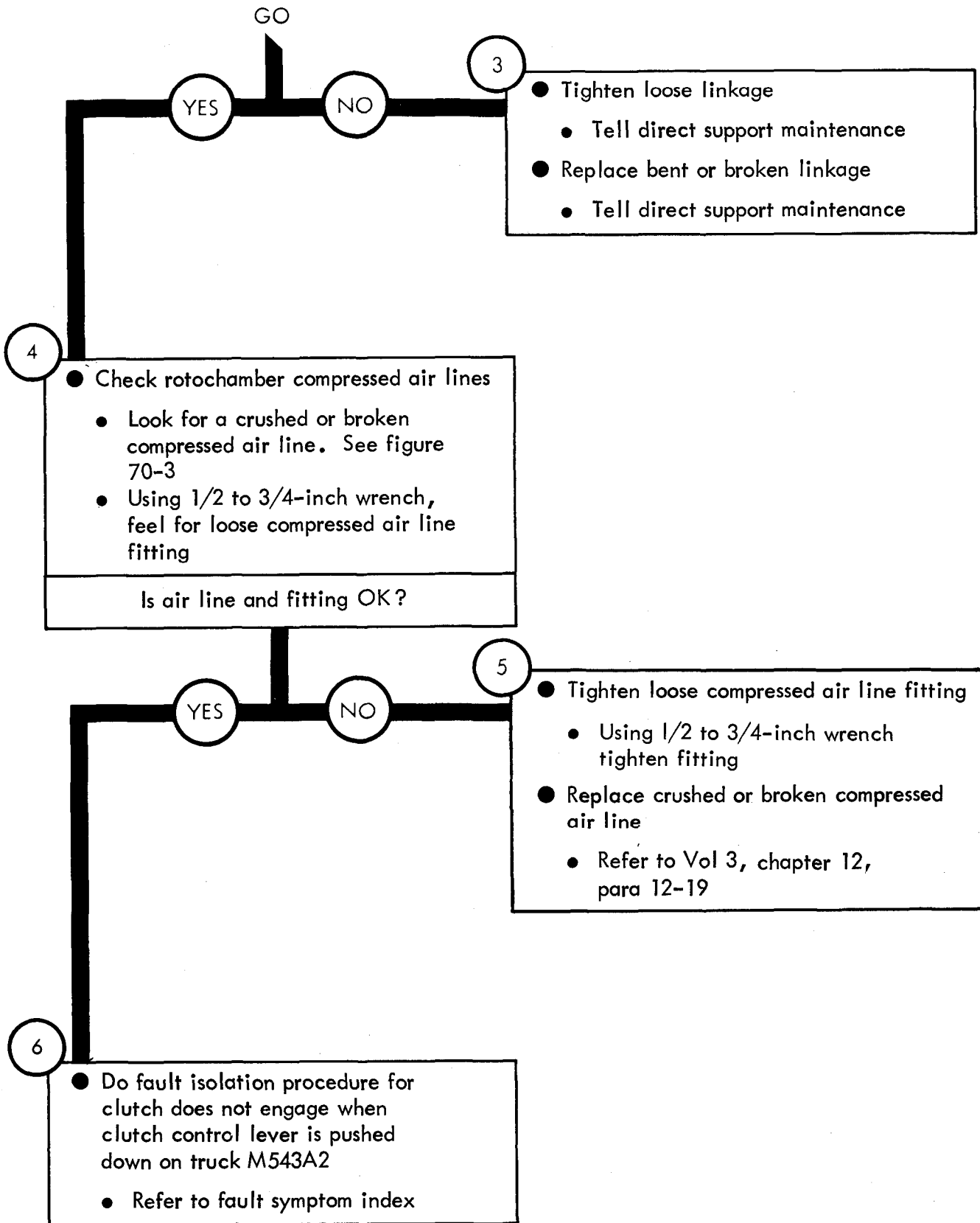

Figure 72-16 (Sheet 2 of 2)

TA 116356

Symptom

17

WINCH DRIVE CONTROL LEVER DOES NOT STAY IN GEAR

1

- Make truck ready for work on wrecker
 - Turn off engine, Refer to TM 9-2320-211-10
 - Chock wheels

2

- Check winch drive control linkage
 - Crawl under truck
 - Look for bent linkage. See figure 70-2
 - Shake linkage to feel if it is loose

Is control linkage OK?

NO

3

- Tighten loose linkage
 - Tell direct support maintenance
- Replace bent linkage
 - Tell direct support maintenance

4

- Overhaul hoist winch gear box
 - Tell direct support maintenance

Figure 72-17

TA 116357

Symptom

18

CRANE DRIVE CONTROL LEVER DOES NOT GO INTO GEAR OR GRINDS WHEN GOING INTO GEAR

1

- Make truck ready for work on wrecker
 - Turn off engine. Refer to TM 9-2320-211-10
 - Chock wheels

2

- Check crane drive control linkage
 - Crawl under truck
 - Look for broken linkage. See figure 70-2
 - Look for bent linkage
 - Shake linkage to feel if it is loose

Is control linkage OK?

YES

NO

3

- Tighten loose linkage
 - Tell direct support maintenance
- Replace bent or broken linkage
 - Tell direct support maintenance

GO

Figure 72-18 (Sheet 1 of 2)

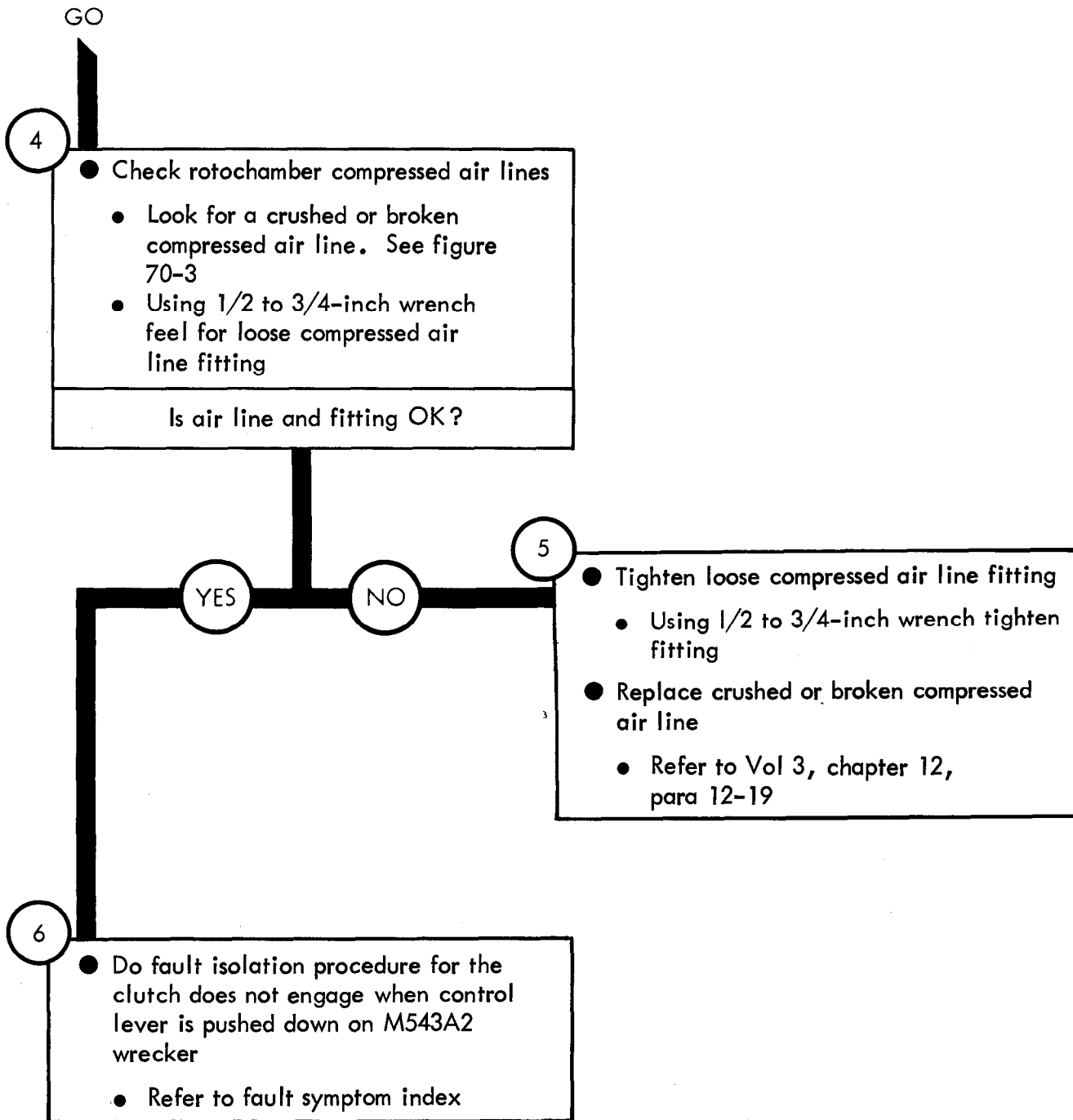

Figure 72-18 (Sheet 2 of 2)

Symptom

19 CRANE DRIVE CONTROL LEVER DOES NOT STAY IN GEAR

- 1
- Secure truck for work on wrecker
 - Turn off engine. Refer to TM 9-2320-211-10
 - Chock wheels

- 2
- Check crane drive control linkage
 - Crawl under truck
 - Look for bent linkage. See figure 70-2
 - Shake linkage to feel if it is loose
- Is control linkage OK?

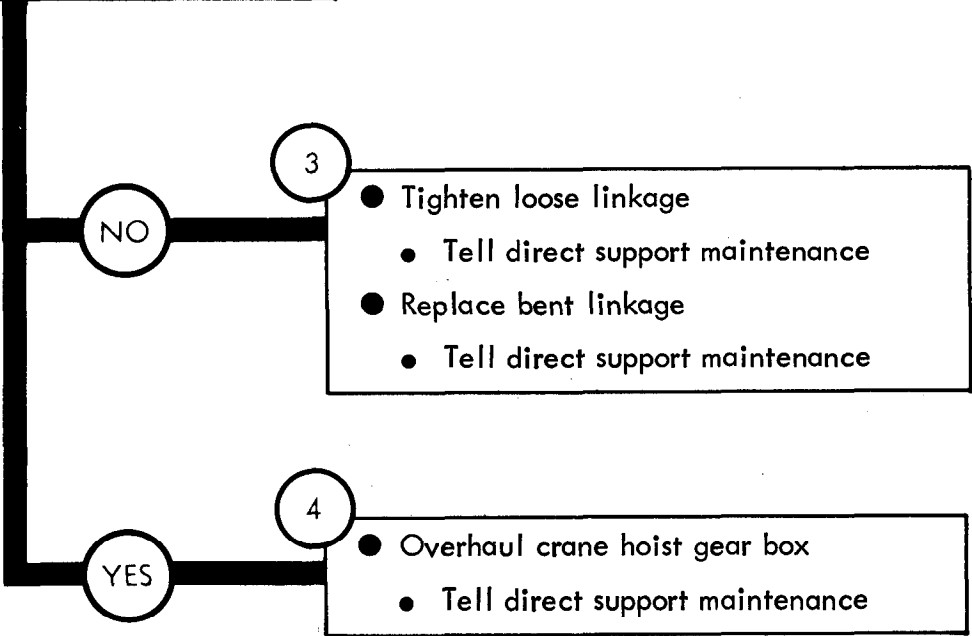

Figure 72-19

TA 116360

CHAPTER 73

WRECKER SYSTEM TROUBLESHOOTING SUMMARY

73-1. GENERAL. This chapter gives a summary of troubleshooting procedures given in chapter 72, for the Wrecker System.

73-2. PROCEDURES . The summary in this chapter covers all fault symptoms found in the detailed troubleshooting procedures in Part 1. Chapter 7 outlines a sample troubleshooting procedure. The summary procedures are based on the "what-to-do" portions of the detailed procedures and do not include the "How-to-do-it" instructions. Warnings, cautions, and notes are given where needed.

WRECKER SYSTEM TROUBLESHOOTING SUMMARY

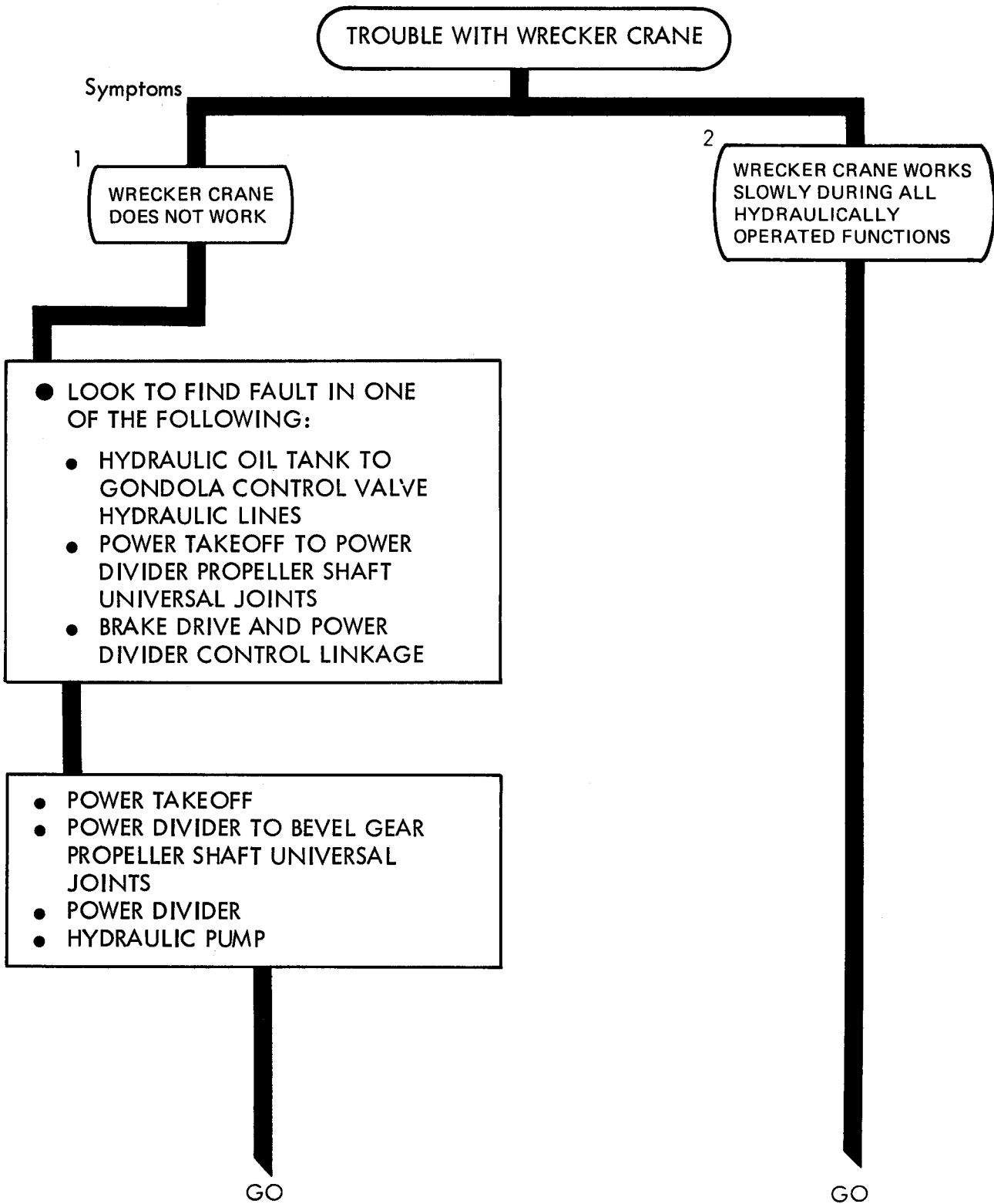

Figure 73-1 (Sheet 1 of 2)

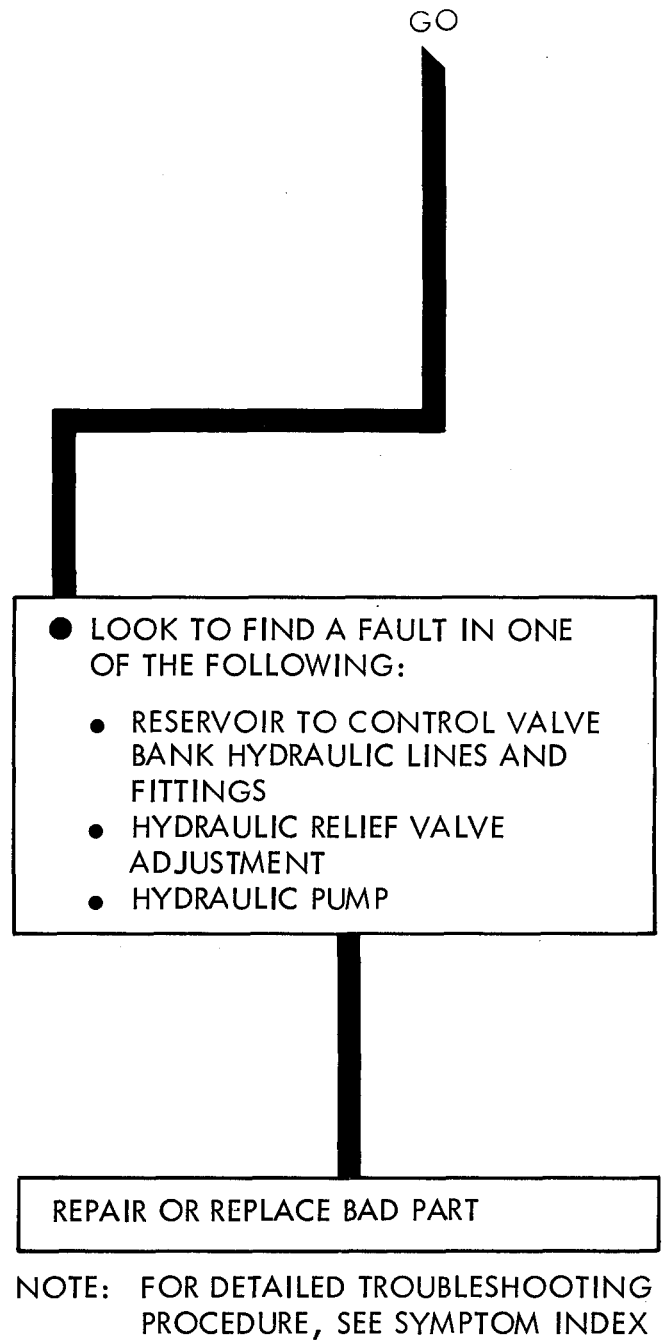
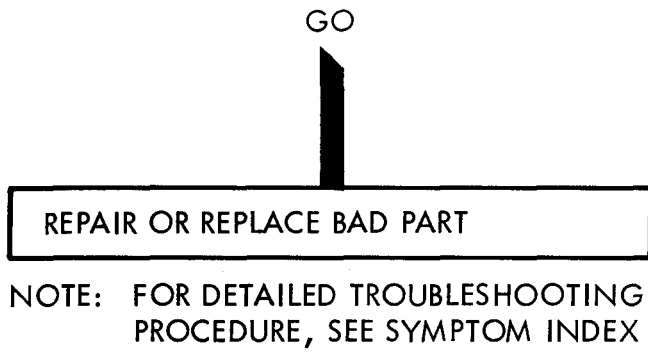

Figure 73-1 (Sheet 2 of 2)

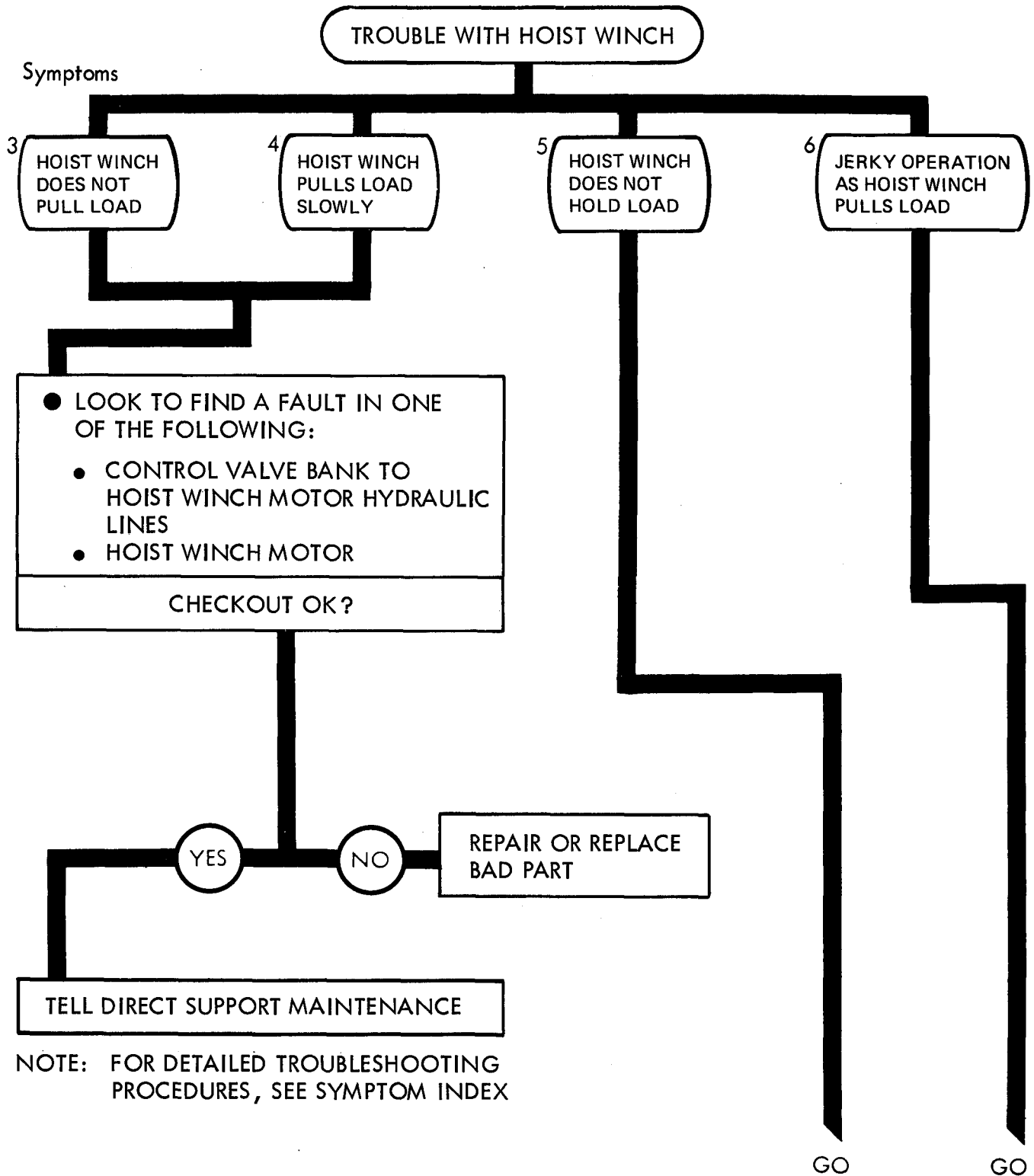
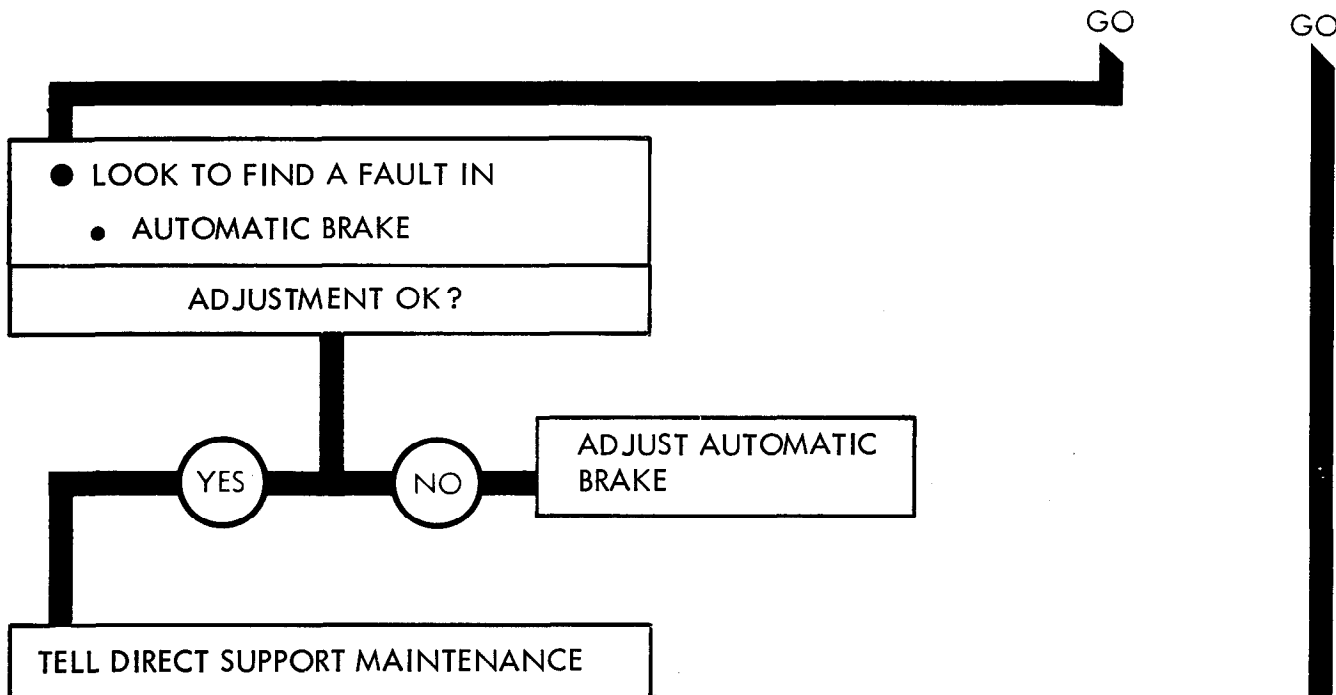
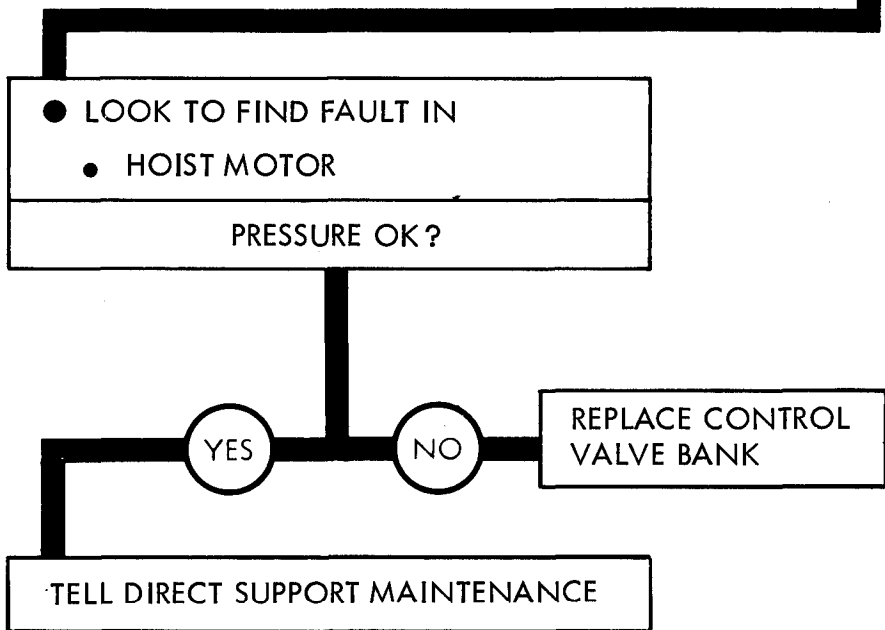

Figure 73-2 (Sheet 1 of 2)

TA 116363



NOTE: FOR DETAILED TROUBLESHOOTING PROCEDURES, SEE SYMPTOM INDEX



NOTE: FOR DETAILED TROUBLESHOOTING PROCEDURES, SEE SYMPTOM INDEX

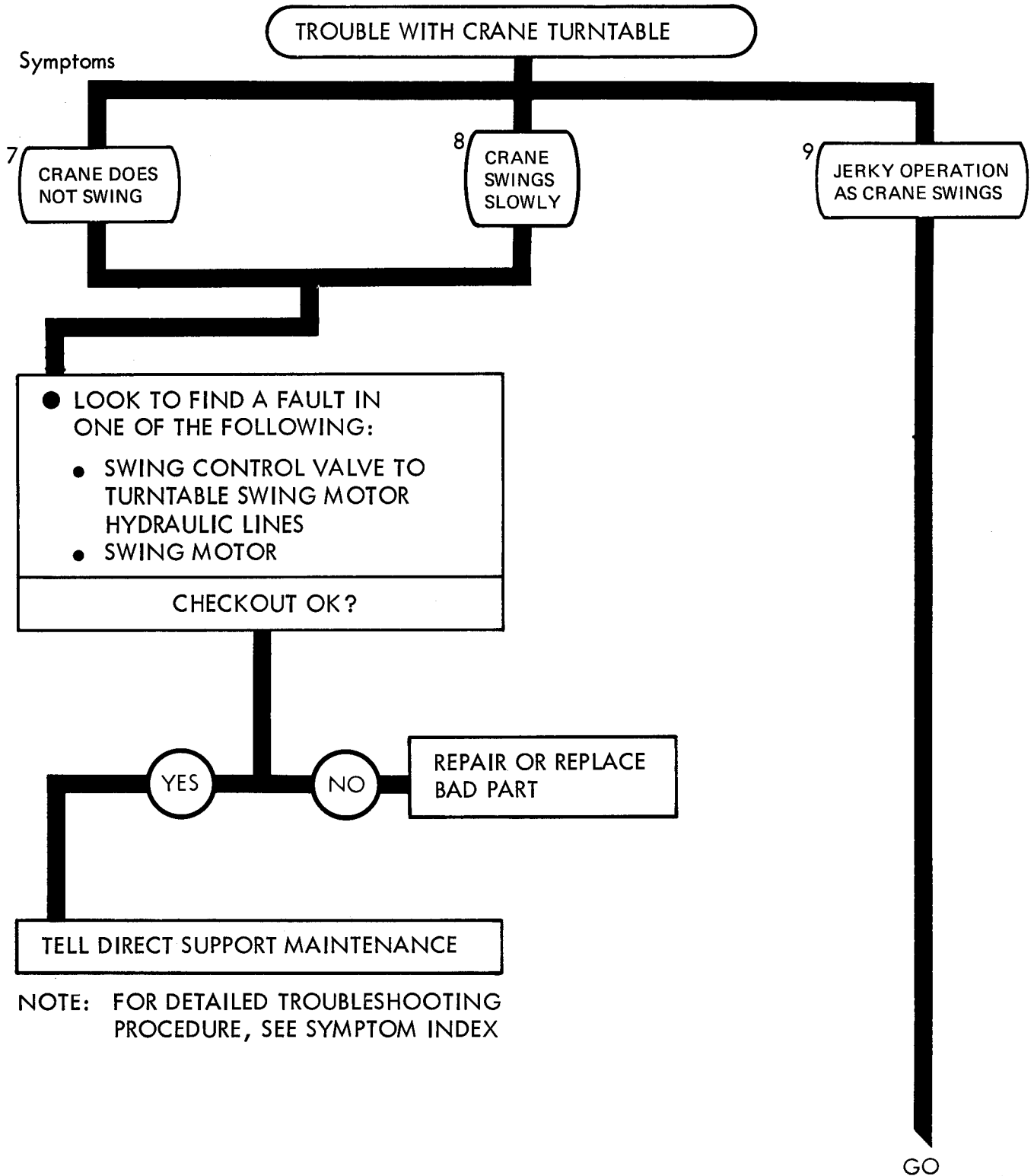

NOTE: FOR DETAILED TROUBLESHOOTING PROCEDURE, SEE SYMPTOM INDEX

Figure 73-3 (Sheet 1 of 2)

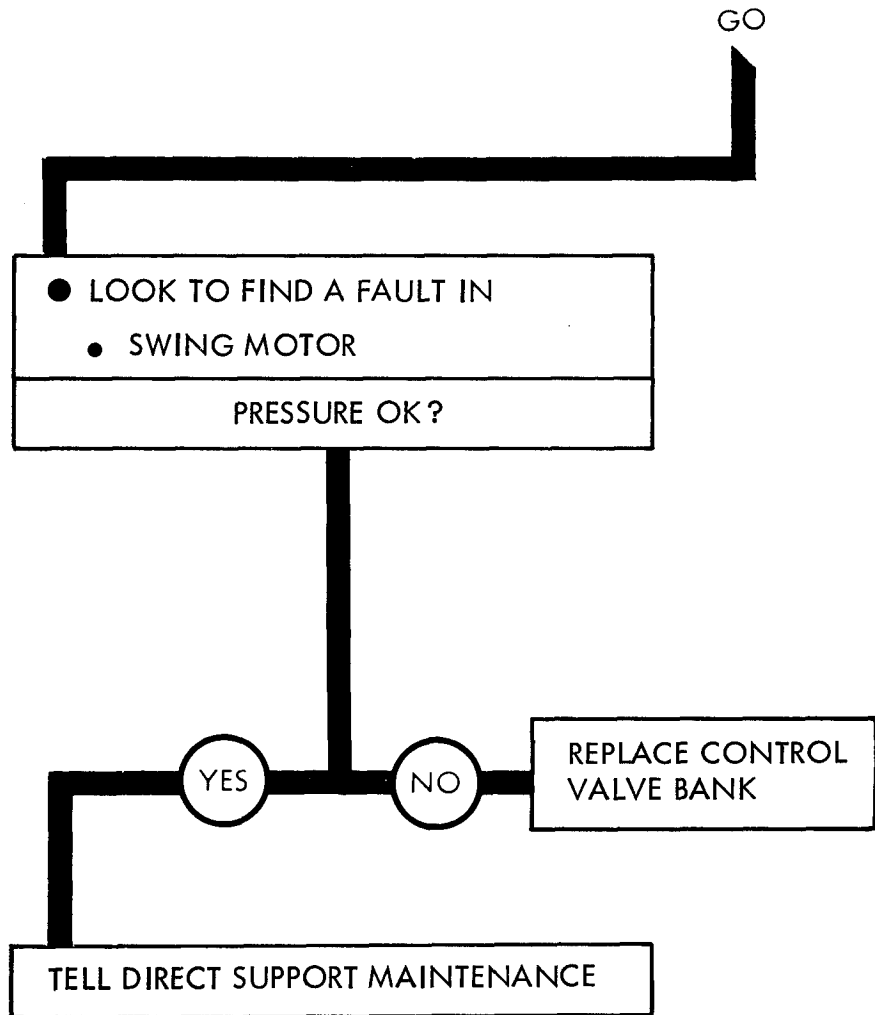

NOTE: FOR DETAILED TROUBLESHOOTING PROCEDURES, SEE SYMPTOM INDEX

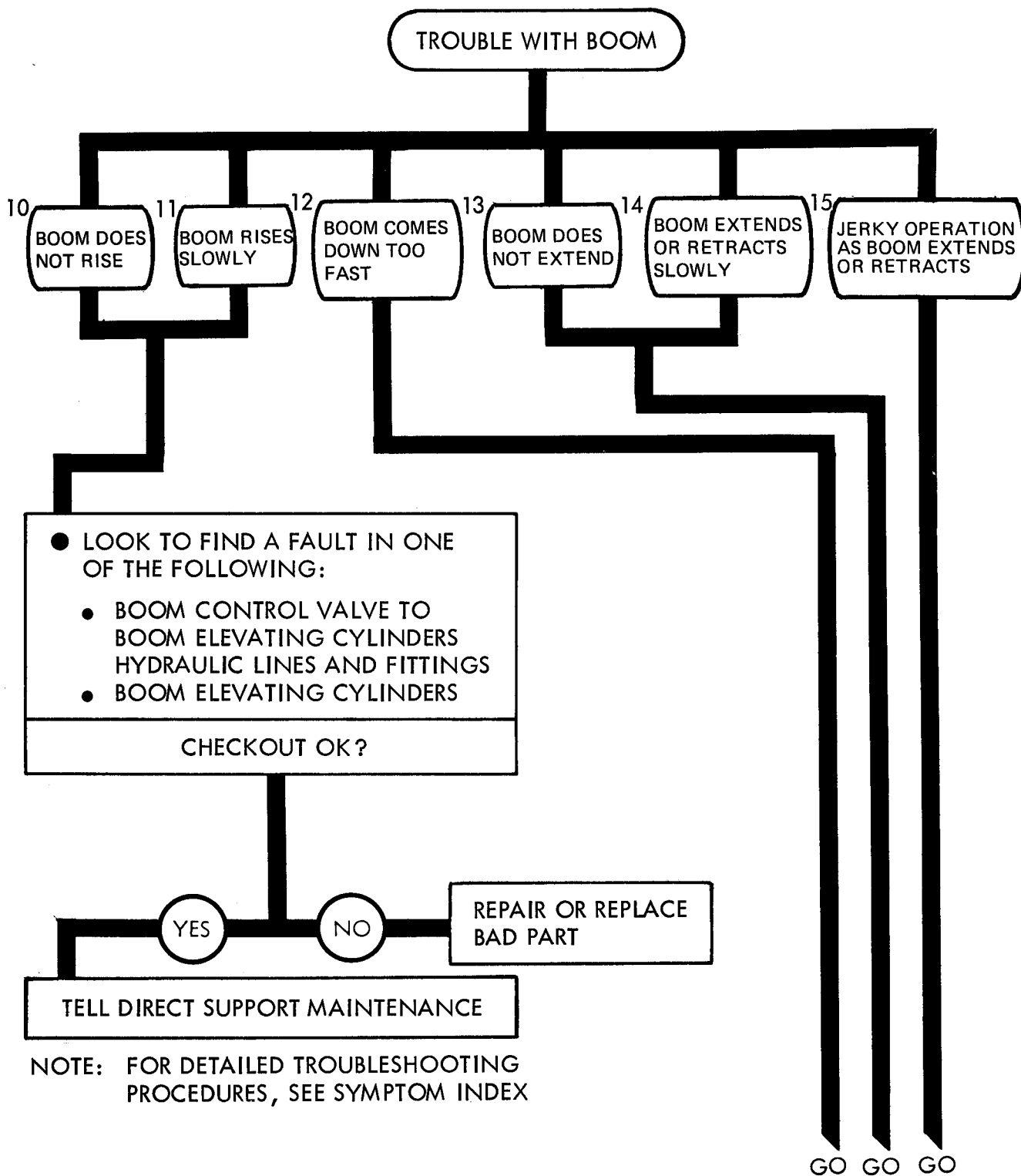

NOTE: FOR DETAILED TROUBLESHOOTING PROCEDURES, SEE SYMPTOM INDEX

Figure 73-4 (Sheet 1 of 4)

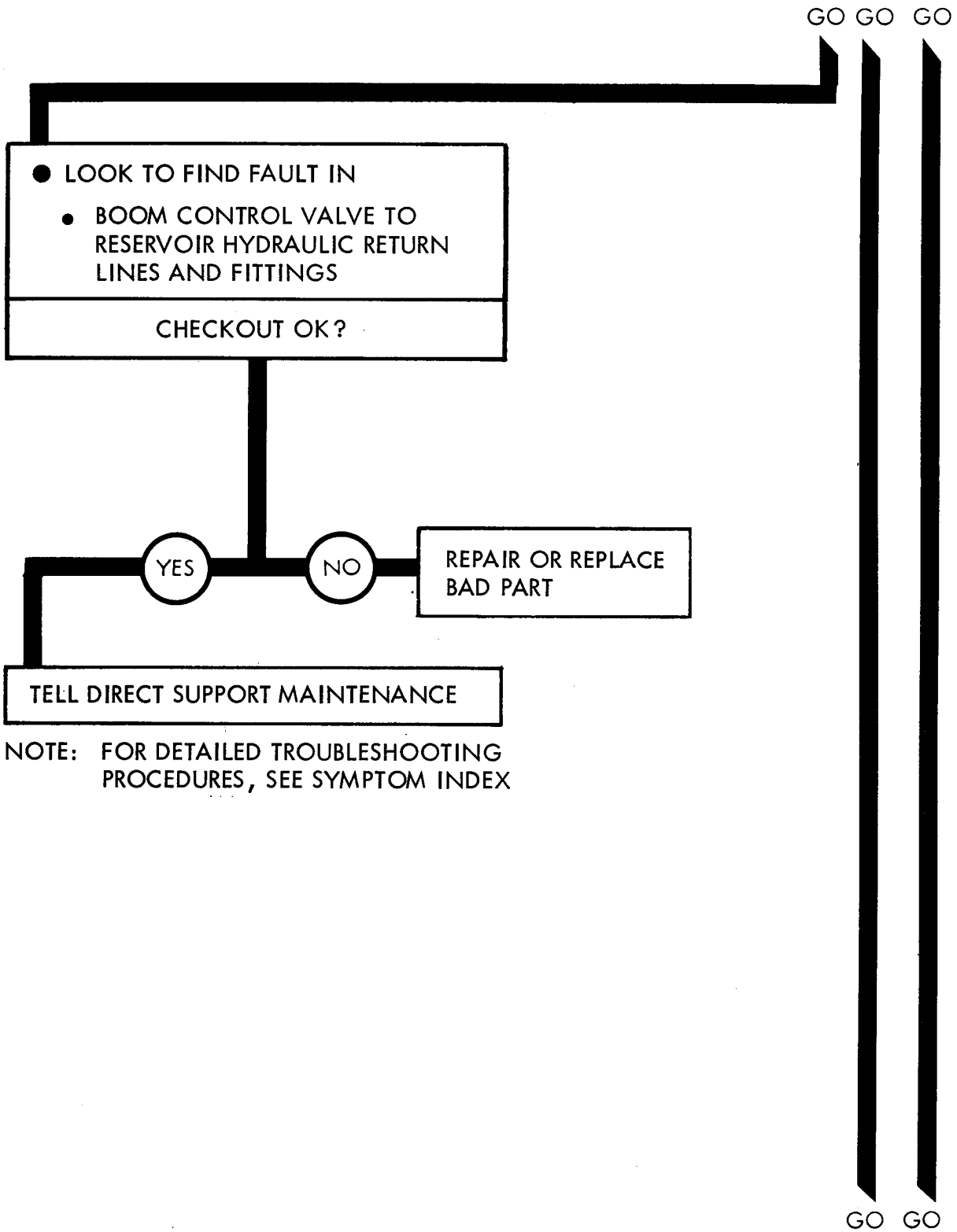

NOTE: FOR DETAILED TROUBLESHOOTING PROCEDURES, SEE SYMPTOM INDEX

Figure 73-4 (Sheet 2 of 4)

TA 116368

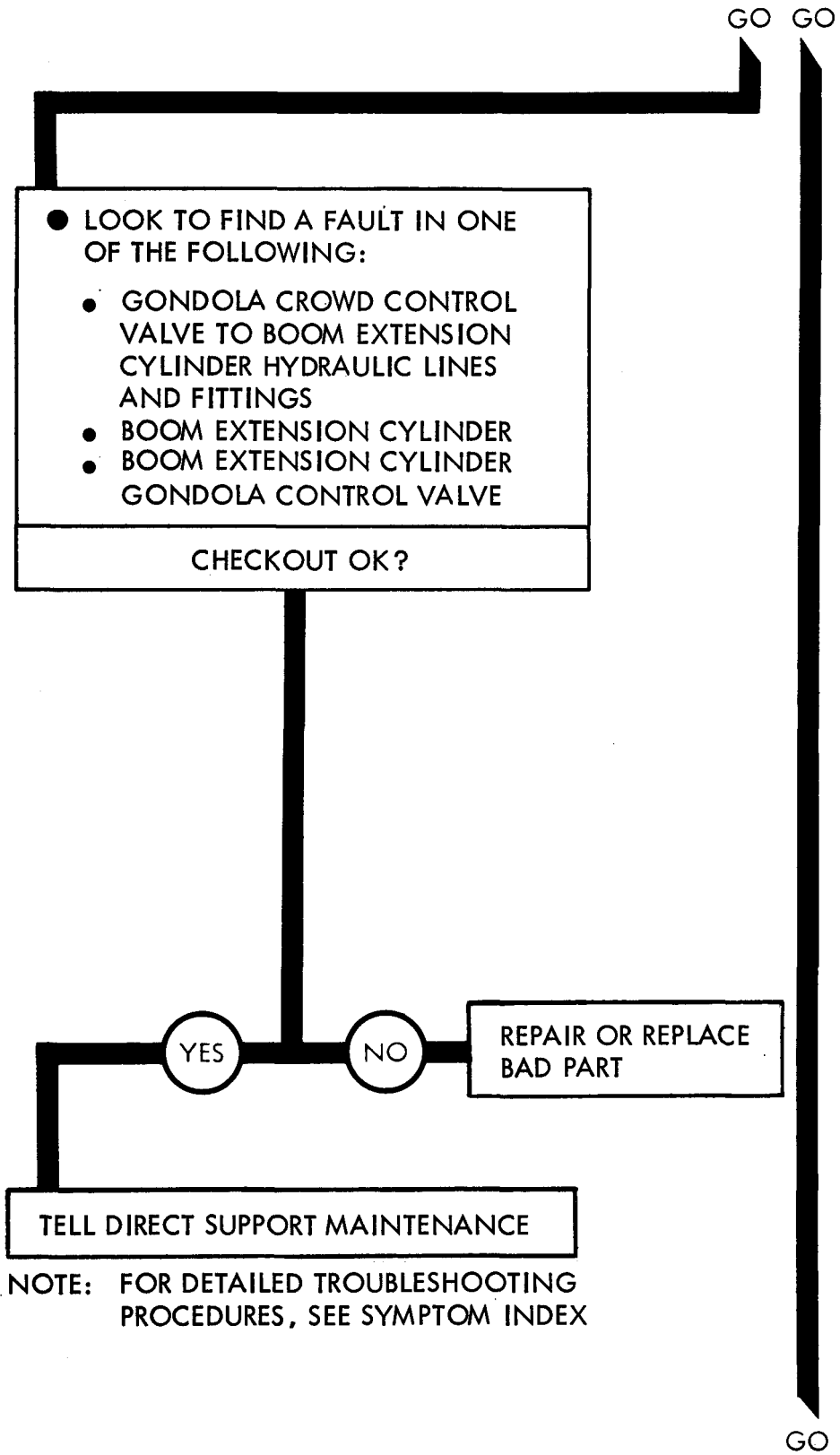
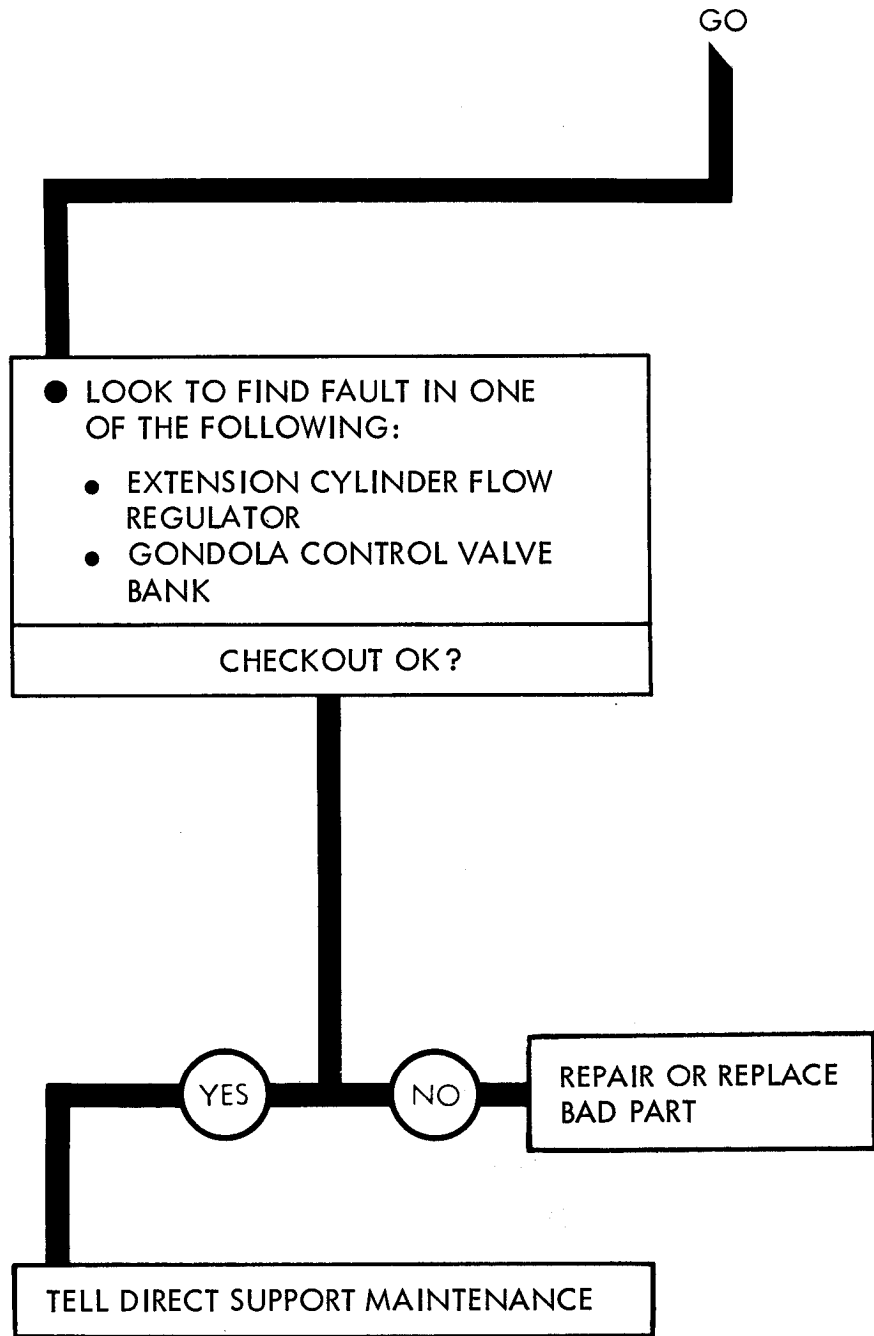

Figure 73-4 (Sheet 3 of 4)



NOTE: FOR DETAILED TROUBLESHOOTING PROCEDURES, SEE SYMPTOM INDEX

Figure 73-4 (Sheet 4 of 4)

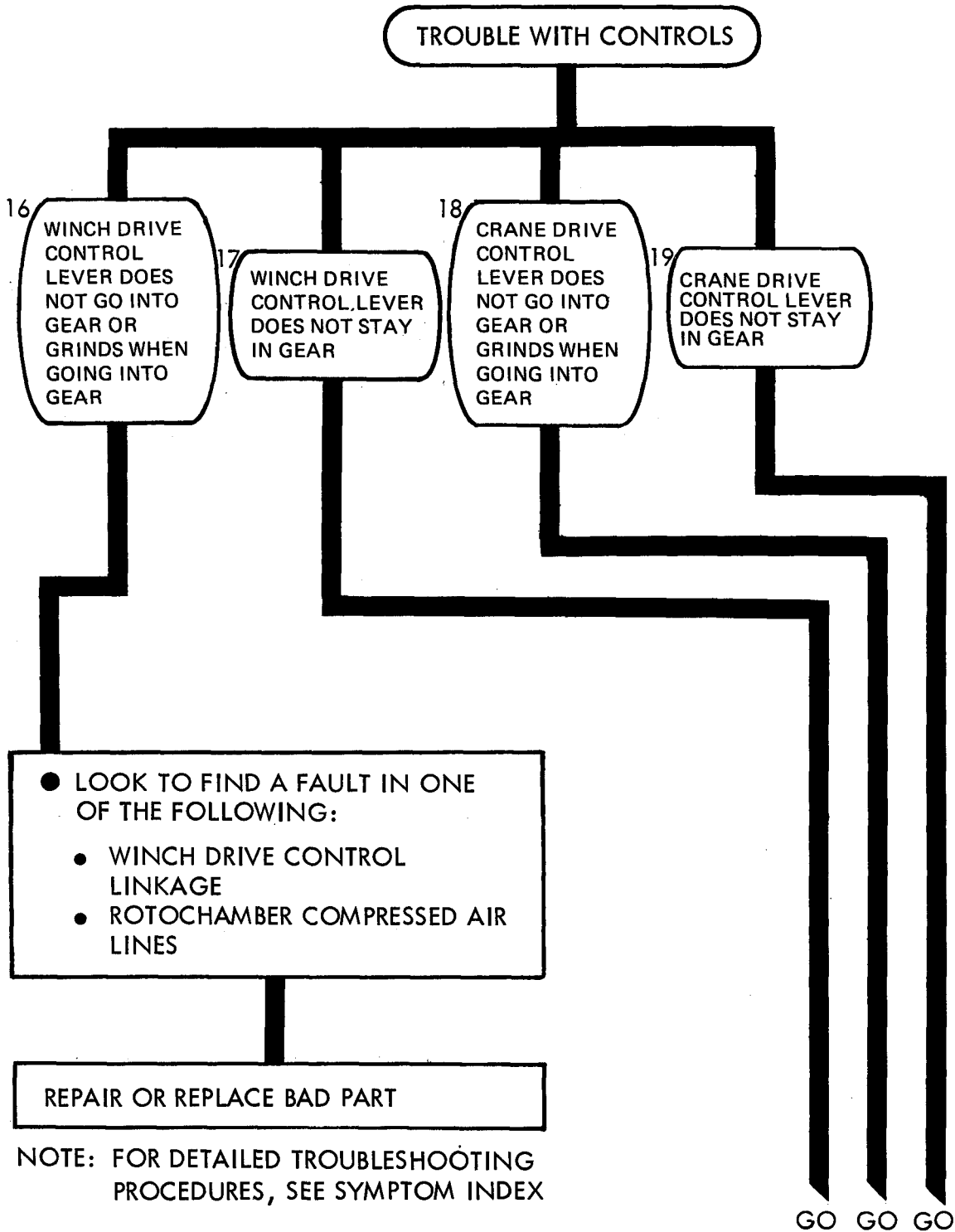

Figure 73-5 (Sheet 1 of 3)

TA 116371

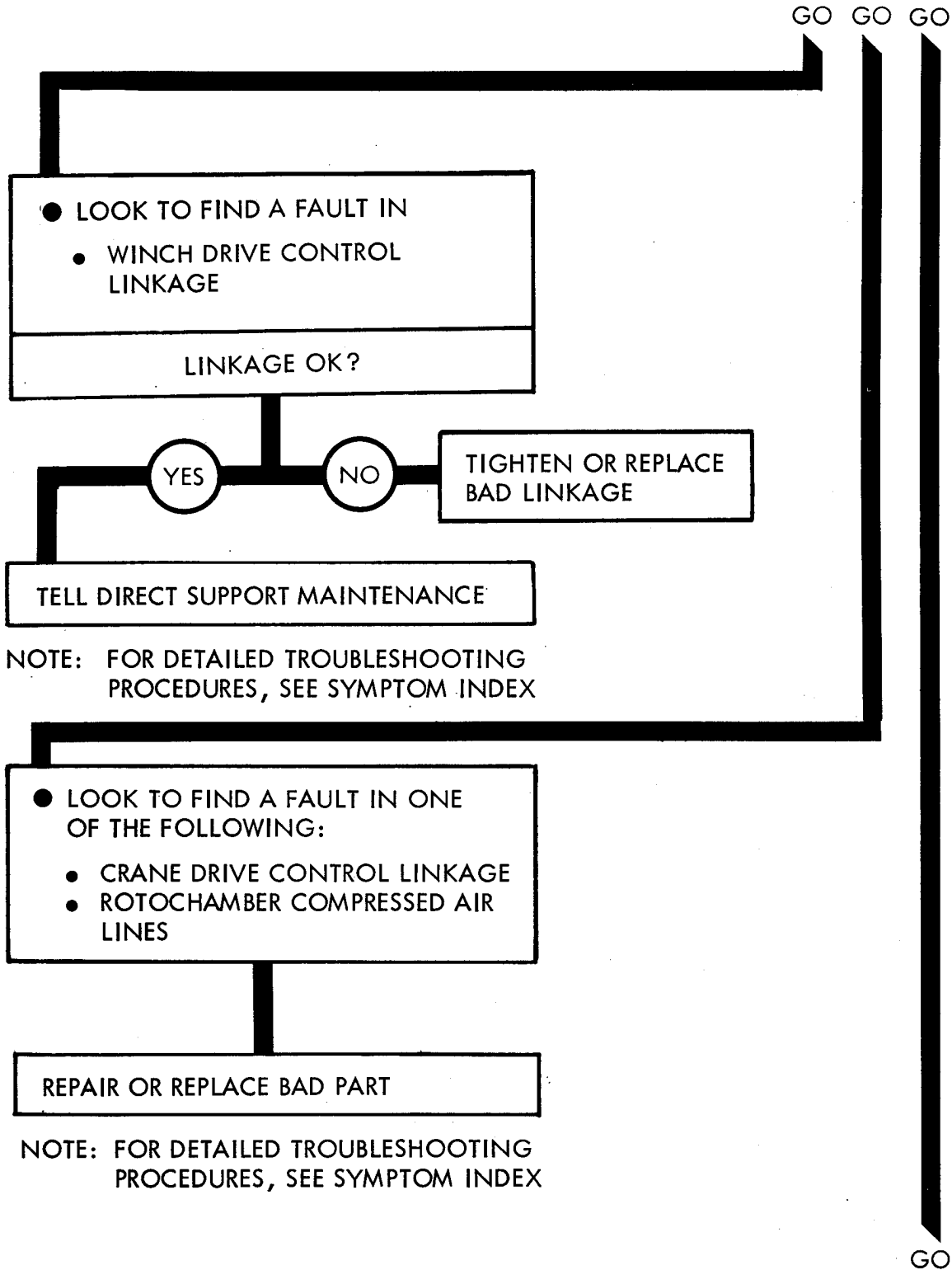

Figure 73-5 (Sheet 2 of 3)

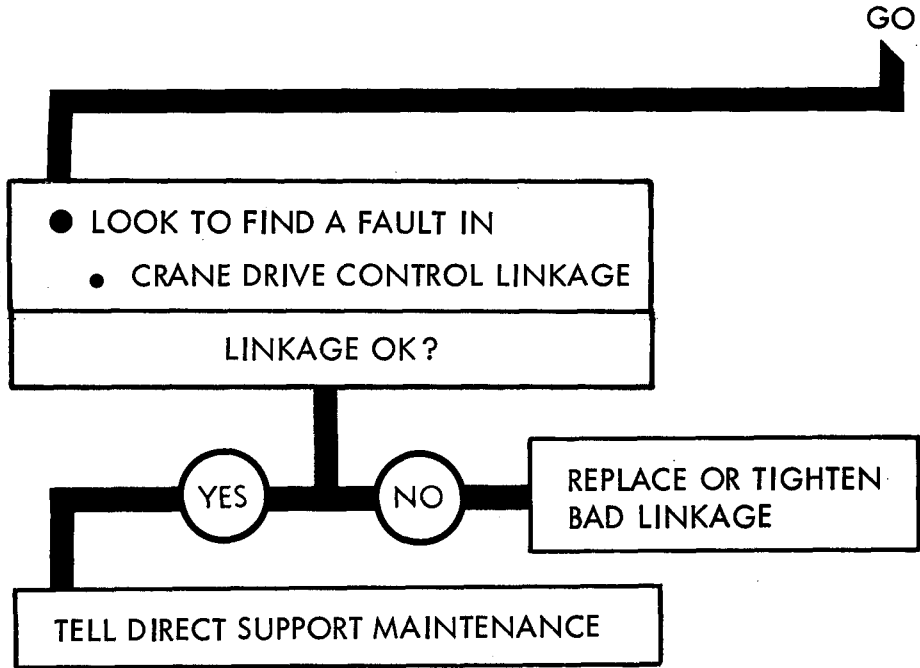

Figure 73-5 (Sheet 3 of 3)

CHAPTER 74

WRECKER SYSTEM SUPPORT DIAGRAMS

74-1. GENERAL. This chapter gives the diagrams you need when doing troubleshooting procedures in chapter 72. Table 3-1 is a complete listing of all support diagrams used in this manual.

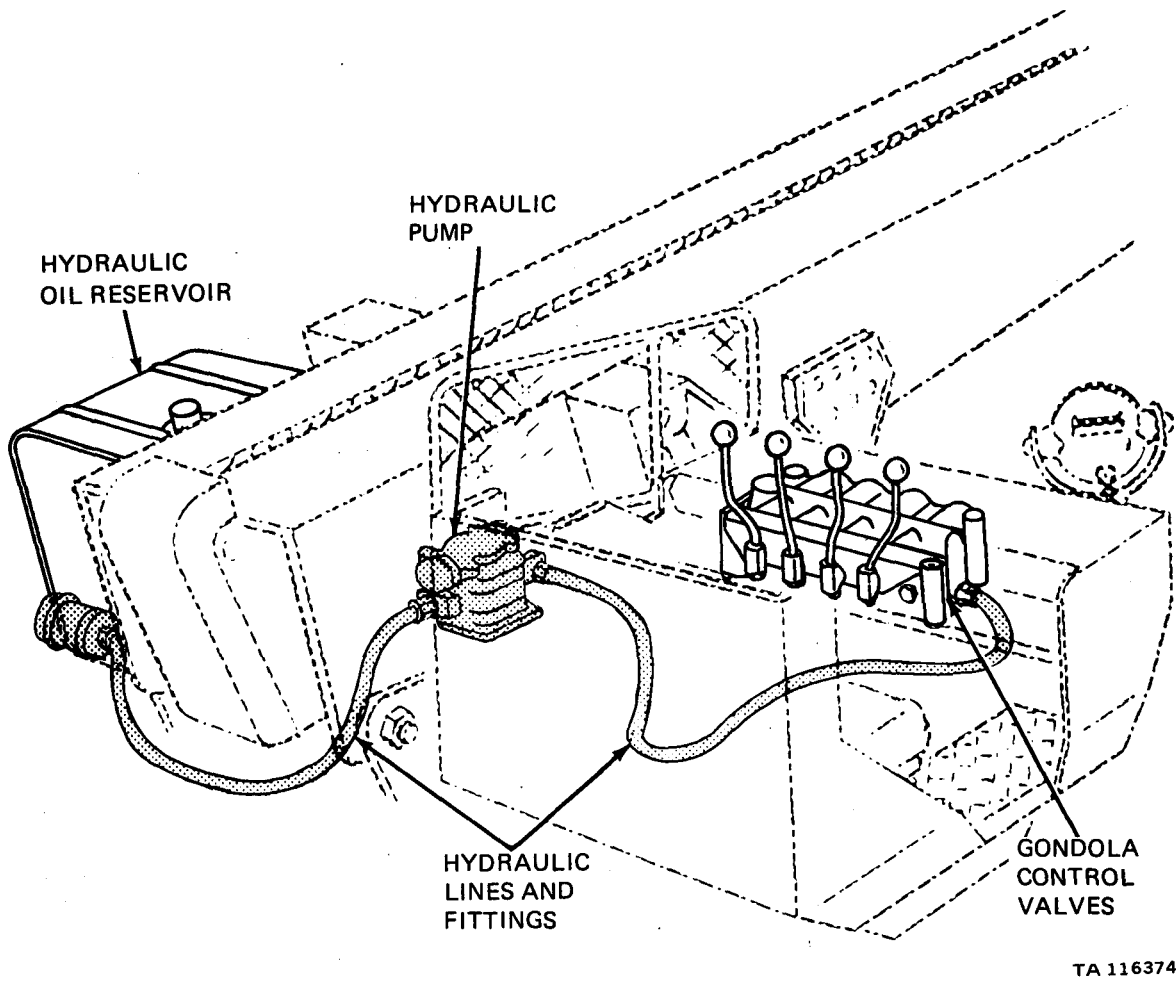

Figure 74-1. Hydraulic Pump System

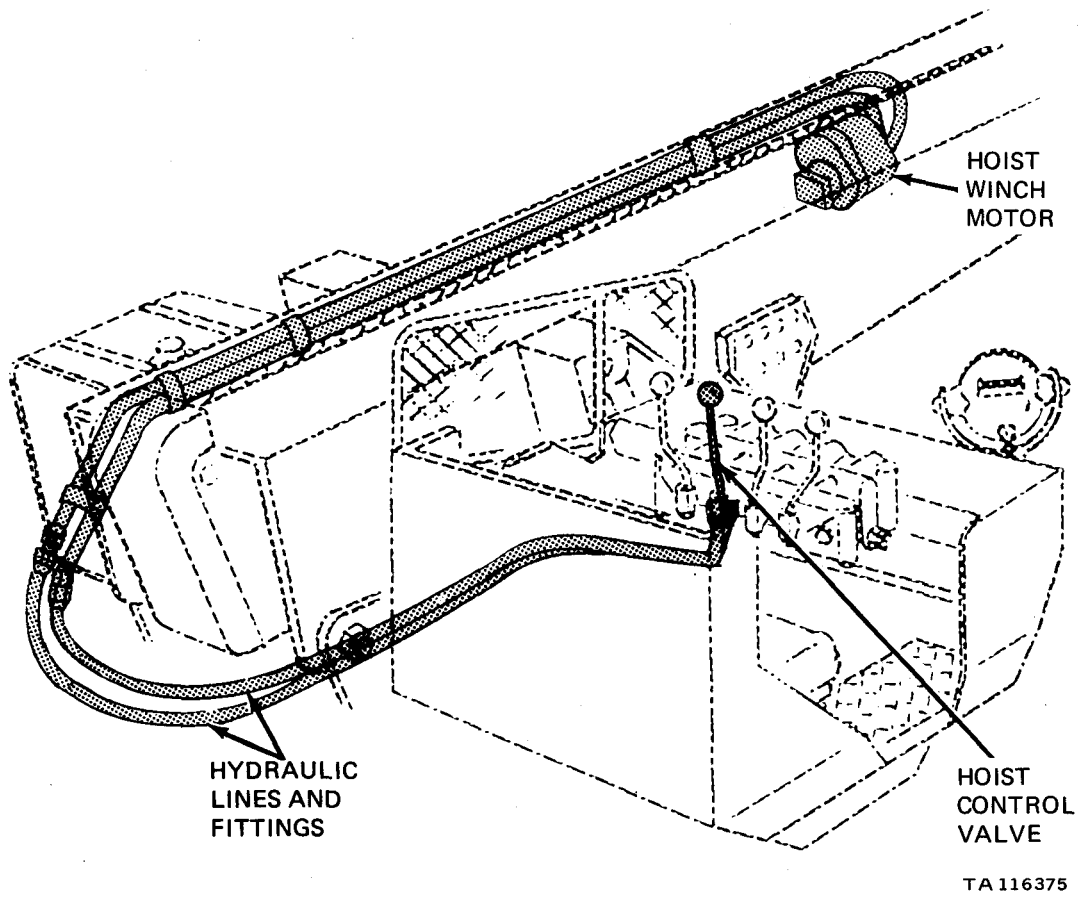
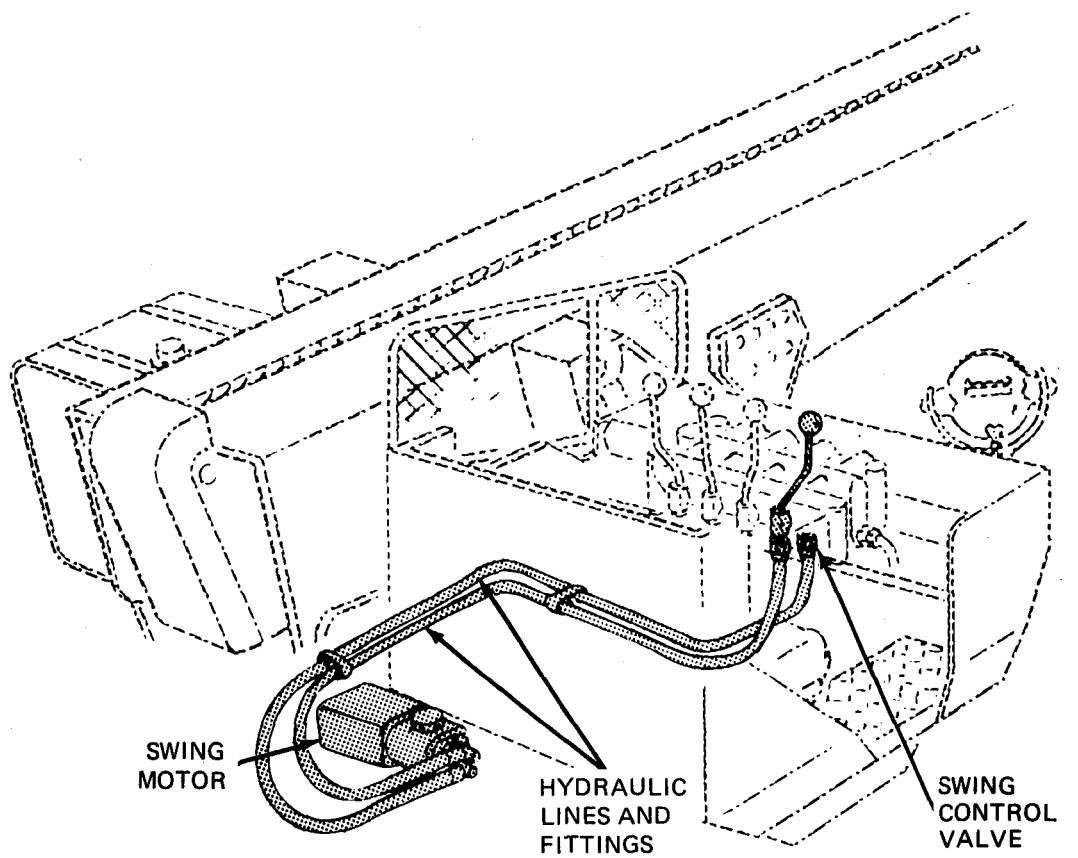
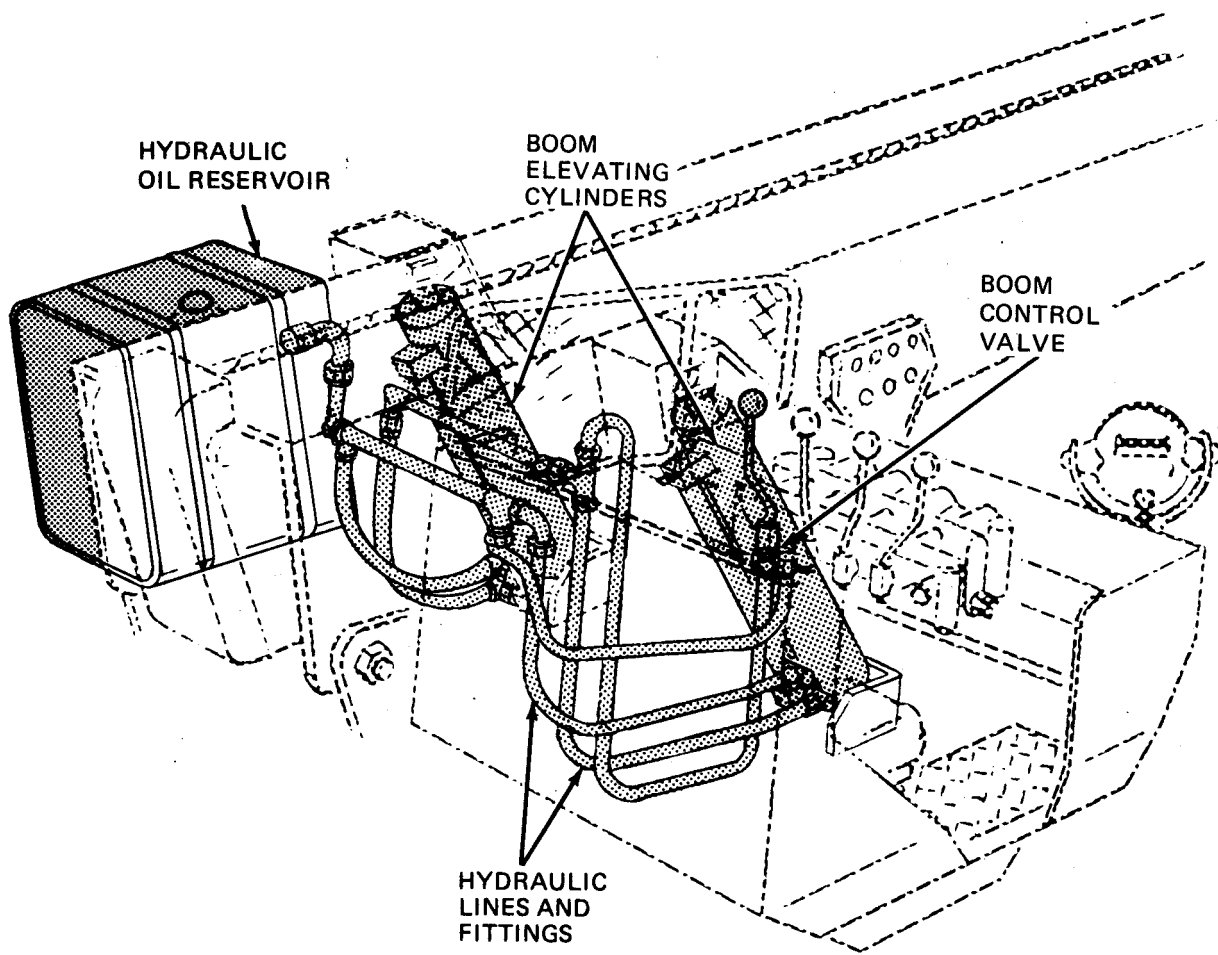

Figure 74-2. Hoist Control Hydraulic System



TA 116376

Figure 74-3. Swing Control Hydraulic System



TA 116377

Figure 74-4. Boom Control Hydraulic System

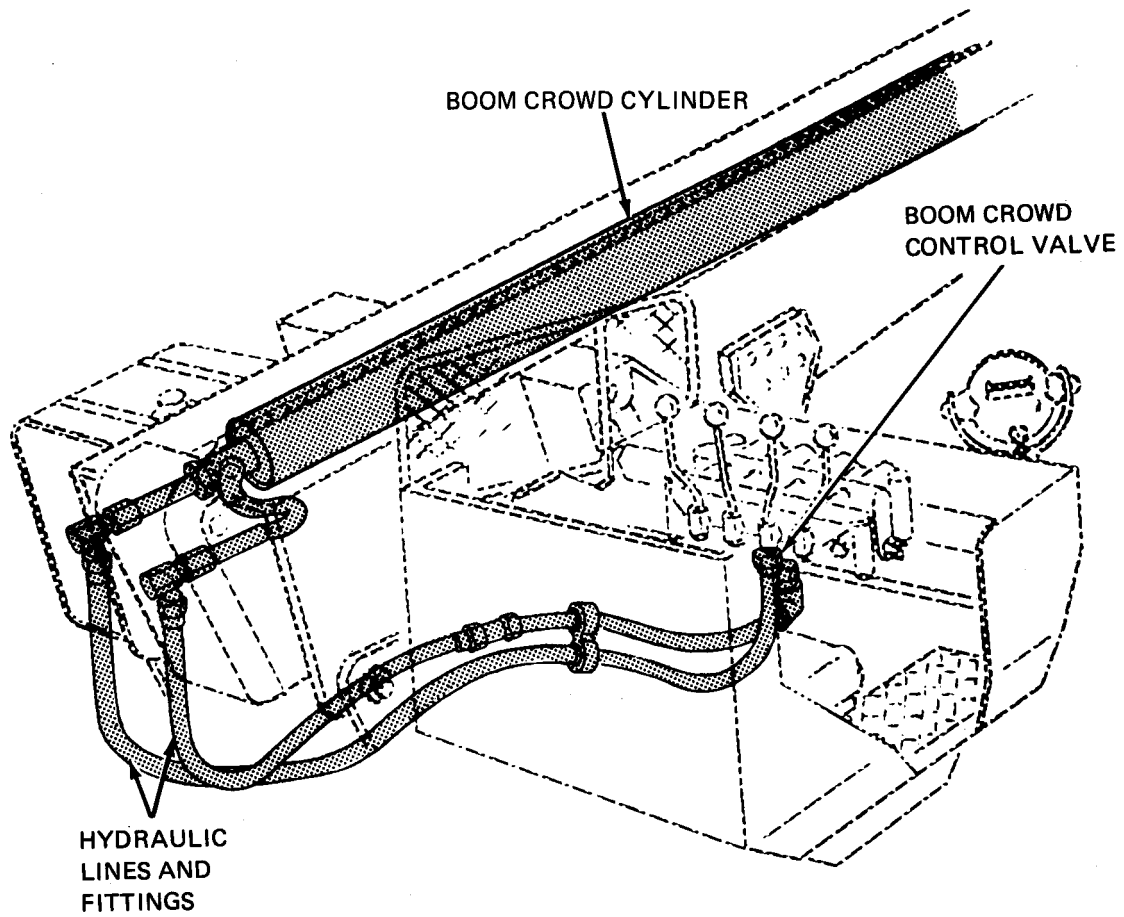

TA 116378

Figure 74-5. Boom Crowd Hydraulic System

CHAPTER 75

WRECKER SYSTEM TEST PROCEDURES

75-1. GENERAL. This chapter gives test procedures for the tests given in chapter 72, for the Wrecker System.

75-2. TEST SET-UP. Instructions for setup of test equipment and parts to be tested are given before the test procedures. Illustrations are used, when needed, to show you how to hook up the test equipment to the part to be tested.

75-3. TEST PROCEDURE. Detailed step-by-step instructions in flow chart form, are given for each test. The procedure calls out the type of test and the condition of the truck system for each part of testing. The step-by-step test will lead you to the bad component or to a fault symptom within a related system. Reference is made to the fault symptom index, chapter 6, if the test shows a fault in another system.

TRUCK M543A2 PRESSURE TEST PROCEDURES

GENERAL INSTRUCTIONS

- Check pressure gage before using
 - Gage - see that the glass and needle are not broken
 - Fitting - make sure fitting is tight on gage. See if fitting end is dirt free

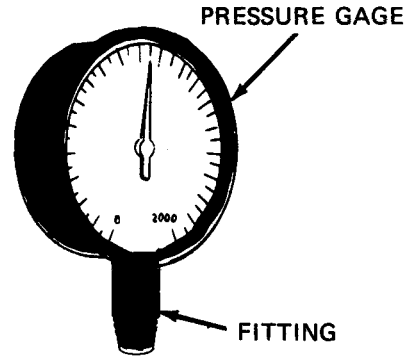

1 BOOM ELEVATING CYLINDER PRESSURE TEST -. To measure hydraulic oil pressure from gondola control valves to boom elevating cylinder

1

- Set up gage as follows
 - Using 1/4-inch breaker bar loosen boom elevating cylinder pipe plug
 - Hold a can or bucket under boom elevating cylinder pipe plug and take off plug
 - Screw in pressure gage and tighten using 9/16-inch wrench

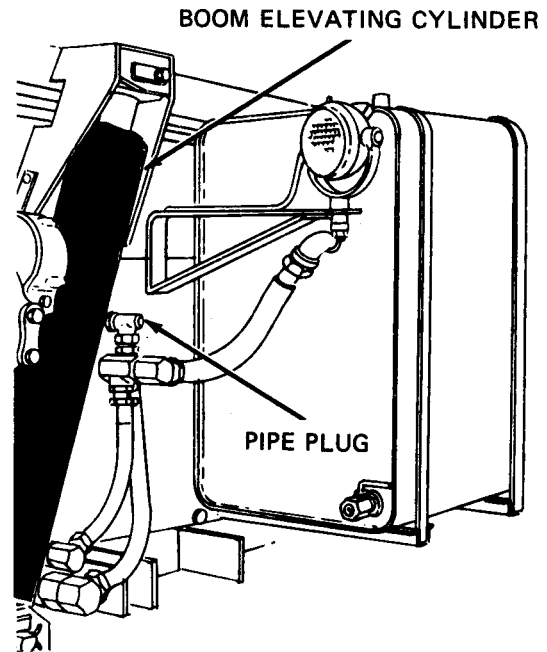

GO

Figure 75-1 (Sheet 1 of 3)

TA 116379

GO

NOTE

The following procedure will need the use of two soldiers. The lead soldier will be called SOLDIER A and the helper will be called SOLDIER B

2

● Test pressure to elevating cylinder as follows

SOLDIER B: ● Start engine and engage wrecker crane drive. Refer to TM 9-2320-211-10

● Go to gondola and wait for instructions from SOLDIER A

SOLDIER A: ● Look at pressure gage

● Tell SOLDIER B to raise boom

SOLDIER B: ● Raise boom as high as it will go. Refer to TM 9-2320-211-10

SOLDIER A: ● See if pressure is between 400 and 450 psi while boom is rising and between 1175 and 1225 psi at stop

● Tell SOLDIER B to lower boom and shut down wrecker crane operation

SOLDIER B: ● Shut down wrecker crane operation. Refer to TM 9-2320-211-10

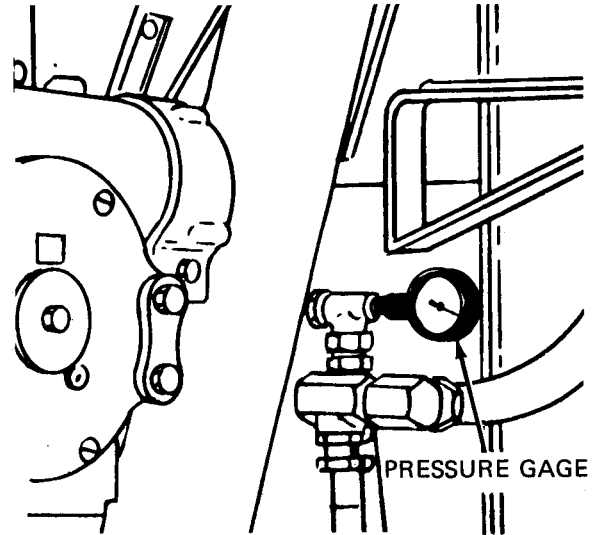

GO

Figure 75-1 (Sheet 2 of 3)

TA 116380

GO

NOTE

Before answering question in fault isolation procedure, test gage must be removed from boom elevating cylinder

3

- Take out pressure gage
 - Using 9/16-inch wrench, unscrew pressure gage
 - Hold a can or bucket under pressure gage and take out gage
 - Screw in pipe plug and tighten using 1/4-inch breaker bar

Figure 75-1 (Sheet 3 of 3)

GENERAL INSTRUCTIONS

- Check pressure gage before using
 - Gage - make sure that the glass and needle are not broken
 - Fitting - make sure fitting is tight on gage. See if fitting end is dirt free

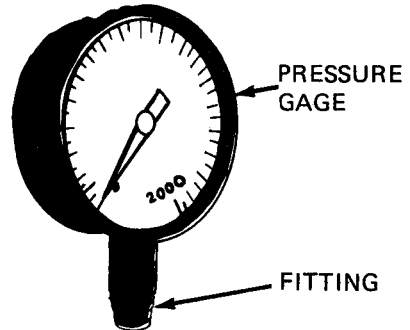

2 SWING MOTOR PRESSURE TEST - To measure hydraulic oil pressure from gondola control valves to swing motor

1

- Set up gage as follows
 - Using 1/4-inch breaker bar unscrew swing motor pipe plug
 - Hold a can or bucket under swing motor and take off plug
 - Screw in pressure gage and tighten using 9/16-inch wrench

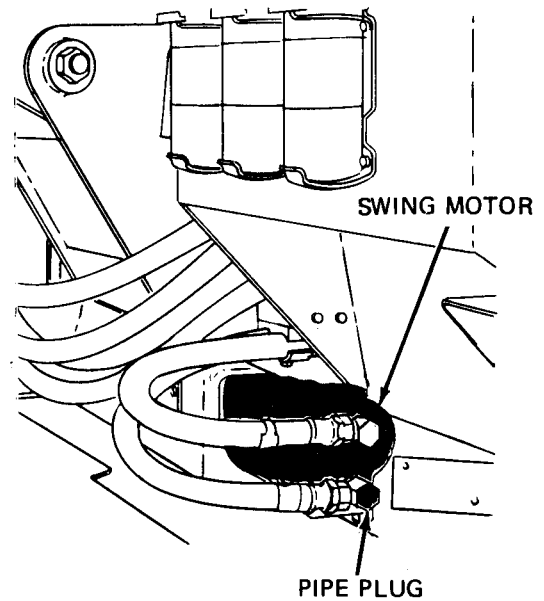

NOTE

The following procedure will need the use of two soldiers. The lead soldier will be called SOLDIER A and the helper will be called SOLDIER B

GO

Figure 75-2 (Sheet 1 of 2)

GO

2

- Test pressure to swing motor as follows
- SOLDIER B:
- Start engine and engage wrecker crane drive. Refer to TM 9-2320-211-10
 - Go to gondola and wait for instructions from SOLDIER A
- SOLDIER A:
- Look at pressure gage
 - Tell SOLDIER B to swing crane

- SOLDIER B:
- Swing crane until it reaches a stop
- SOLDIER A:
- See if pressure gage reads between 700 and 750 psi, while it swings and 1175 and 1225 psi at stop
- SOLDIER B:
- Shut down from wrecker crane operation. Refer to TM 9-2320-211-10

NOTE

Before answering question in fault isolation procedure, test gage must be removed from swing motor

3

- Take out pressure gage
 - Using 9/16-inch wrench, unscrew pressure gage
 - Hold a can or bucket under pressure gage and take out gage
 - Screw in pipe plug and tighten using 1/4-inch breaker bar

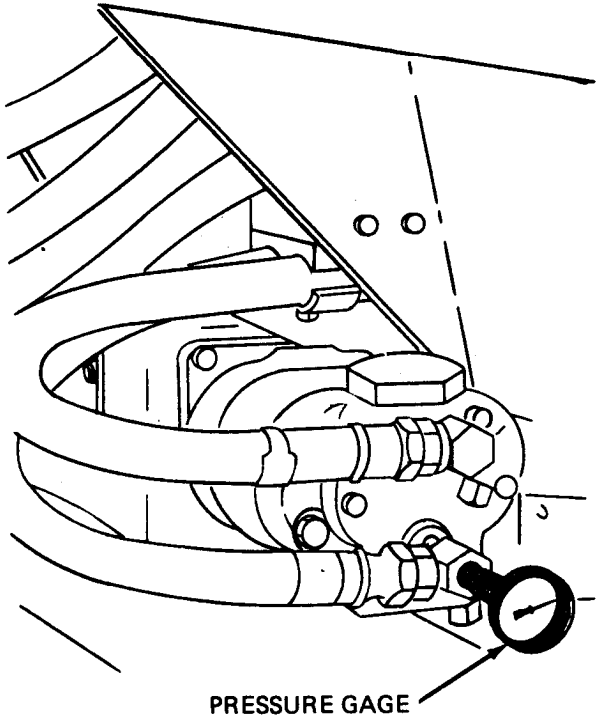
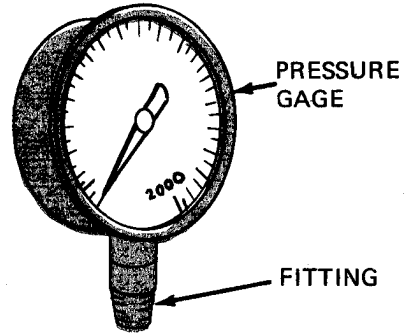

Figure 75-2 (Sheet 2 of 2)

TA 116383

GENERAL INSTRUCTIONS

- Check pressure gage before using
 - Gage - make sure that the glass and needle are not broken
 - Fitting - make sure fitting is tight on gage. See if fitting end is dirt free



3 HYDRAULIC PUMP PRESSURE TEST - To measure hydraulic oil pressure from hydraulic pump

1

- Set up gage as follows
 - Remove gondola control valve data plate assembly. Tell direct support maintenance
 - Using 3/16-inch wrench, unscrew and take out pipe plug
 - Screw in pressure gage and tighten using 7/16-inch wrench

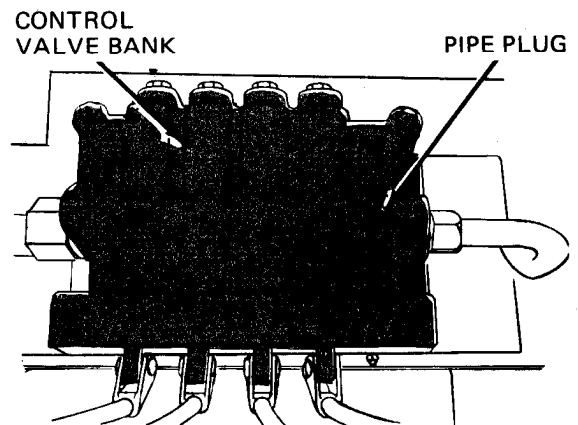

GO

Figure 75-3 (Sheet 1 of 2)

GO

2

- Test pressure at gondola control valve bank
 - Start engine and engage wrecker crane drive. Refer to TM 9-2320-211-10
 - Go to gondola and extend boom until it stops. Refer to TM 9-2320-211-10
 - Look at pressure gage
 - See if pressure is between 1250 and 1350 psi with boom fully extended
 - Shut down from wrecker crane operation. Refer to TM 9-2320-211-10

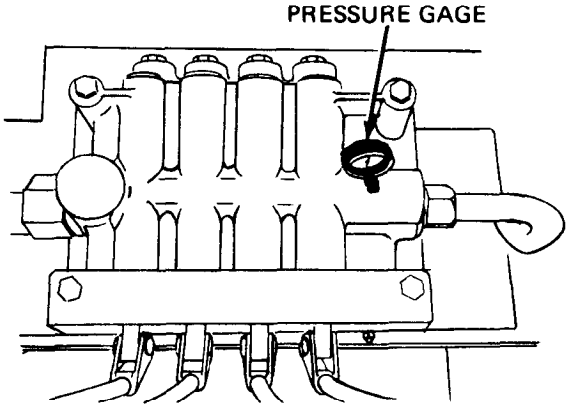

NOTE

Before answering questions in fault isolation procedure, test gage must be removed from control valve bank

3

- Take out pressure gage
 - Using 9/16-inch wrench, unscrew and take out pressure gage
 - Screw in pipe plug and tighten using 1/4-inch wrench
- Put back gondola control valve data plate assembly
 - Tell direct support maintenance

Figure 75-3 (Sheet 2 of 2)

GENERAL INSTRUCTIONS

- Check pressure gage before using
 - Gage - see that the glass and needle are not broken
 - Fitting - make sure fitting is tight on gage. See if fitting end is dirt free

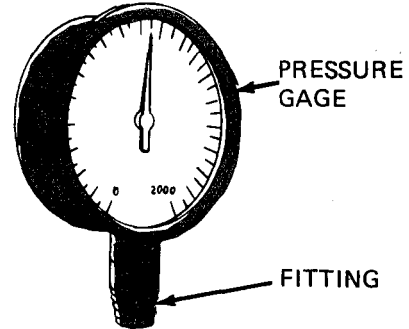

4 HOIST MOTOR PRESSURE TEST - To measure hydraulic oil pressure from gondola control valves to hoist motor

1

- Set up gage as follows
 - Using 1/4-inch breaker bar unscrew hoist motor pipe plug
 - Hold a can or bucket under hoist motor pipe plug and take off plug
 - Screw in pressure gage and tighten using 9/16-inch wrench

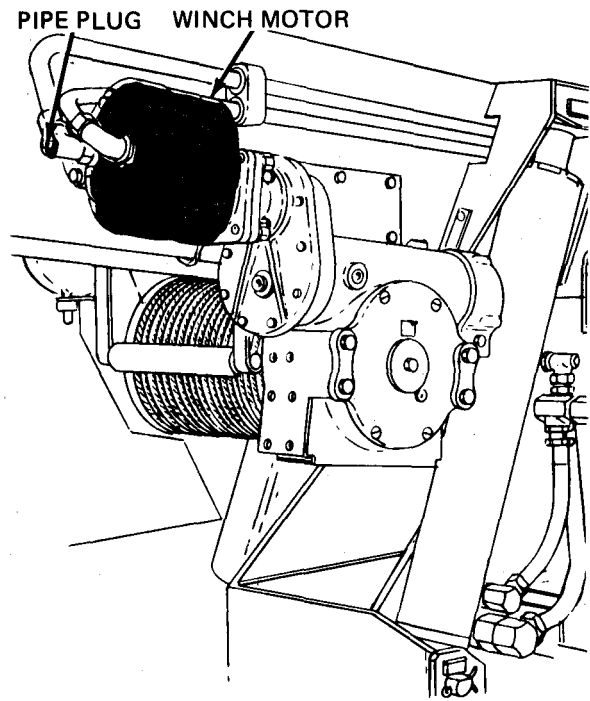

GO

Figure 75-4 (Sheet 1 of 3)

TA 116386

GO

NOTE

The following procedure will need the use of two soldiers. The lead soldier will be called SOLDIER A and the helper will be called SOLDIER B

2

- Test pressure to hoist motor as follows
- SOLDIER B:
- Start engine and engage wrecker crane drive. Refer to TM 9-2320-211-10
 - Go to gondola and wait for instructions from SOLDIER A
- SOLDIER A:
- Look at pressure gage
 - Tell SOLDIER B to raise hoist

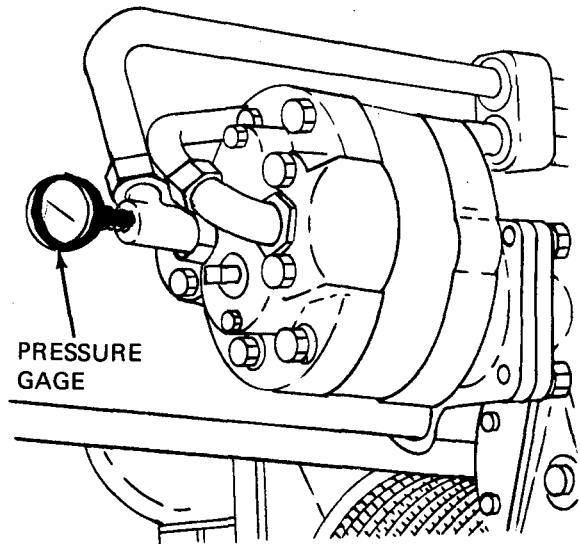

- SOLDIER B:
- Operate hoist. Refer to TM 9-2320-211-10
- SOLDIER A:
- See if pressure gage reads between 425 and 500 psi while raising hoist
 - Tell SOLDIER B to shut down wrecker crane operation
- SOLDIER B:
- Shut down wrecker crane operation. Refer to TM 9-2320-211-10

GO

Figure 75-4 (Sheet 2 of 3)

GO

NOTE

Before answering question in fault isolation procedure, test gage must be removed from boom elevating cylinder

3

- Take out pressure gage
 - Using 9/16-inch wrench, unscrew pressure gage
 - Hold a can or bucket under pressure gage and take out gage
 - Screw in pipe plug and tighten using 1/4-inch breaker bar

Figure 75-4 (Sheet 3 of 3)

TRUCK M543A2 PRESSURE TEST PROCEDURES

GENERAL INSTRUCTIONS

- Check pressure gage before using
 - Gage - make sure that the glass and needle are not broken
 - Fitting - make sure fitting is tight on gage. See if fitting end is dirt free

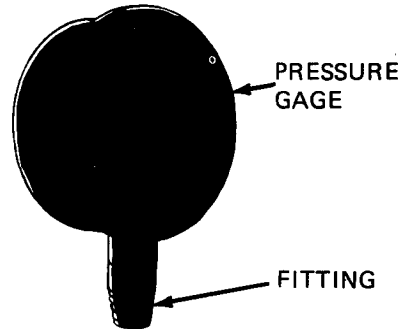

5 BOOM EXTENSION CYLINDER GONDOLA CONTROL VALVE OUTPUT PRESSURE TEST - To check output pressure at gondola control valve bank

1

- Set up gage as follows
 - Put a bucket, or can under boom extension cylinder control valve
 - Using a 1/2-inch wrench unscrew and take off output hydraulic line at control valve
 - Screw a suitable T-fitting onto control valve and tighten using wrench
 - Put a hydraulic line on T-fitting end and tighten using 1/2-inch wrench
 - Screw in pressure gage to T-fitting and tighten using wrench

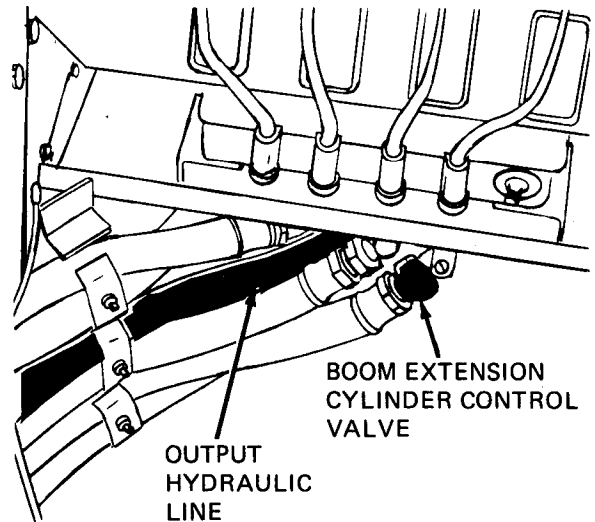

GO

Figure 75-5 (Sheet 1 of 2)

TA 116389

GO

2

- Test output pressure from boom extension cylinder control valve
 - Start engine and engage wrecker crane drive. Refer to TM 9-2320-211-10
 - Go to gondola and extend boom until it stops. Refer to TM 9-2320-211-10
 - Look at pressure gage
 - See if pressure is between 400 to 450 psi as boom is in motion and between 1175 and 1225 psi with boom fully extended
 - Retract boom and shut down wrecker crane operations. Refer to TM 9-2320-211-10

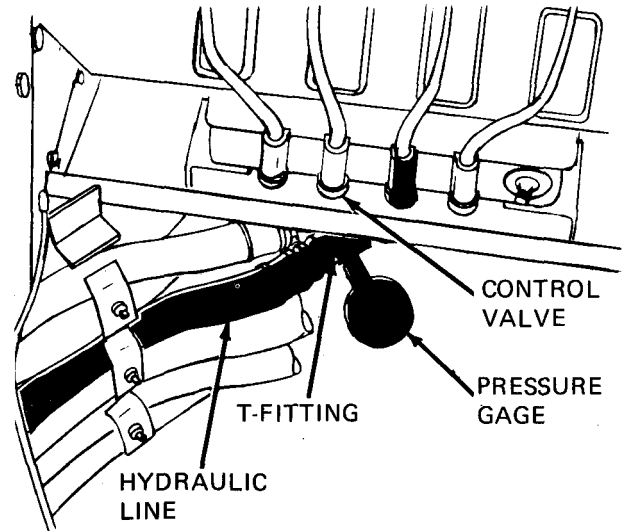

NOTE

Before answering question in fault isolation procedures, test gage must be removed from control valve bank

3

- Take out pressure gage
 - Using wrench unscrew and take out pressure gage
 - Using 1/2-inch wrench unscrew and take off hydraulic line
 - Using wrench unscrew and take out T-fitting
 - Put hydraulic line back on control valve bank fitting and tighten using 1/2-inch wrench

TRUCK M543A2 PRESSURE TEST PROCEDURES

GENERAL INSTRUCTIONS

- Check pressure gage before using
 - Gage - make sure that glass and pointer are not broken
 - Fitting - make sure fitting is tight on gage. See if fitting end is dirt free

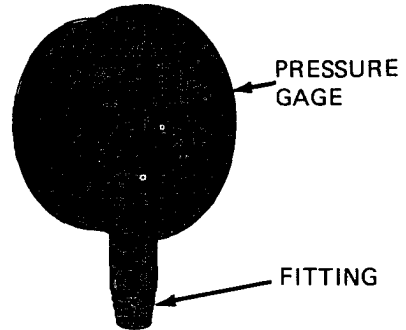

6 BOOM EXTENSION CYLINDER INPUT PRESSURE TEST - To measure oil pressure from gondola control valves to boom extension cylinder

1

- Set up gage as follows
 - Using 1/4-inch breaker bar unscrew boom extension cylinder pipe plug
 - Hold a can or bucket under extension cylinder and take off plug
 - Screw in pressure gage until tight using 9/16-inch wrench

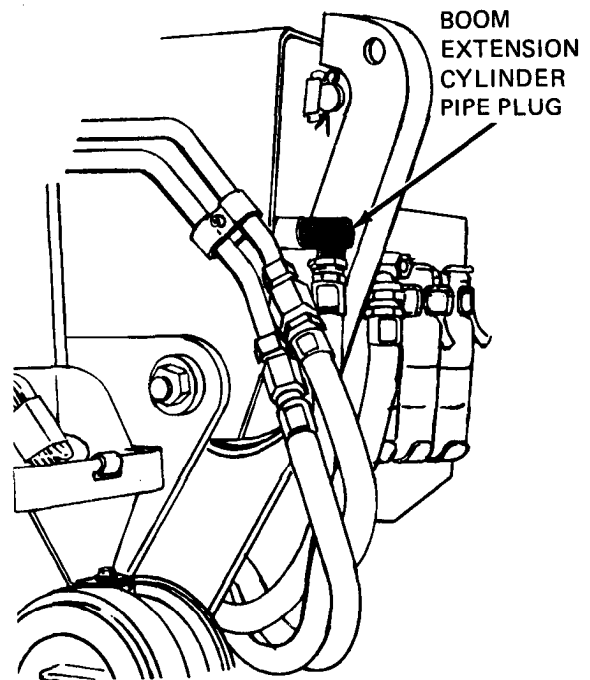

GO

TA 116391

Figure 75-6 (Sheet 1 of 3)

GO

NOTE

The following procedure will need the use of two soldiers. The lead soldier will be called SOLDIER A and the helper will be called SOLDIER B

2

● Test pressure to extension cylinder as follows

SOLDIER B: ● Start engine and engage wrecker crane drive. Refer to TM 9-2320-211-10

● Go to gondola and wait for instructions from SOLDIER A

SOLDIER A: ● Look at pressure gage

● Tell SOLDIER B to extend boom

SOLDIER B: ● Extend boom to its limit. Refer to TM 9-2320-211-10

SOLDIER A: ● See if pressure gage reads between 475 and 525 psi while boom extends and between 1175 and 1225 psi fully extended

● Tell SOLDIER B to retract boom and shut down wrecker crane operation

SOLDIER B: ● Retract boom and shut down wrecker crane operation. Refer to TM 9-2320-211-10

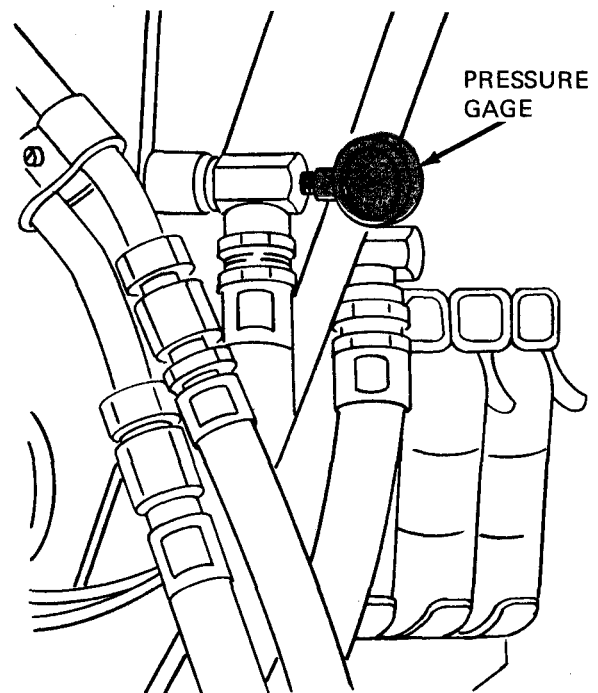

GO

TA 116392

Figure 75-6 (Sheet 2 of 3)

GO

NOTE

Before answering question in fault isolation procedure, test gage must be removed from boom elevating cylinder

3

- Take out pressure gage
 - Using 9/16-inch wrench unscrew pressure gage
 - Hold a can or bucket under pressure gage and take out gage
 - Screw in pipe plug and tighten using 1/4-inch breaker bar

CHAPTER 76

WRECKER SYSTEM CHECKOUT PROCEDURES

76-1. GENERAL. This chapter gives procedures for checking out the system after troubleshooting and repair have been done. Procedures are set up in flow chart form showing the checkout steps in order and referring to the fault symptom index when the system does not checkout.

WRECKER SYSTEM CHECKOUT

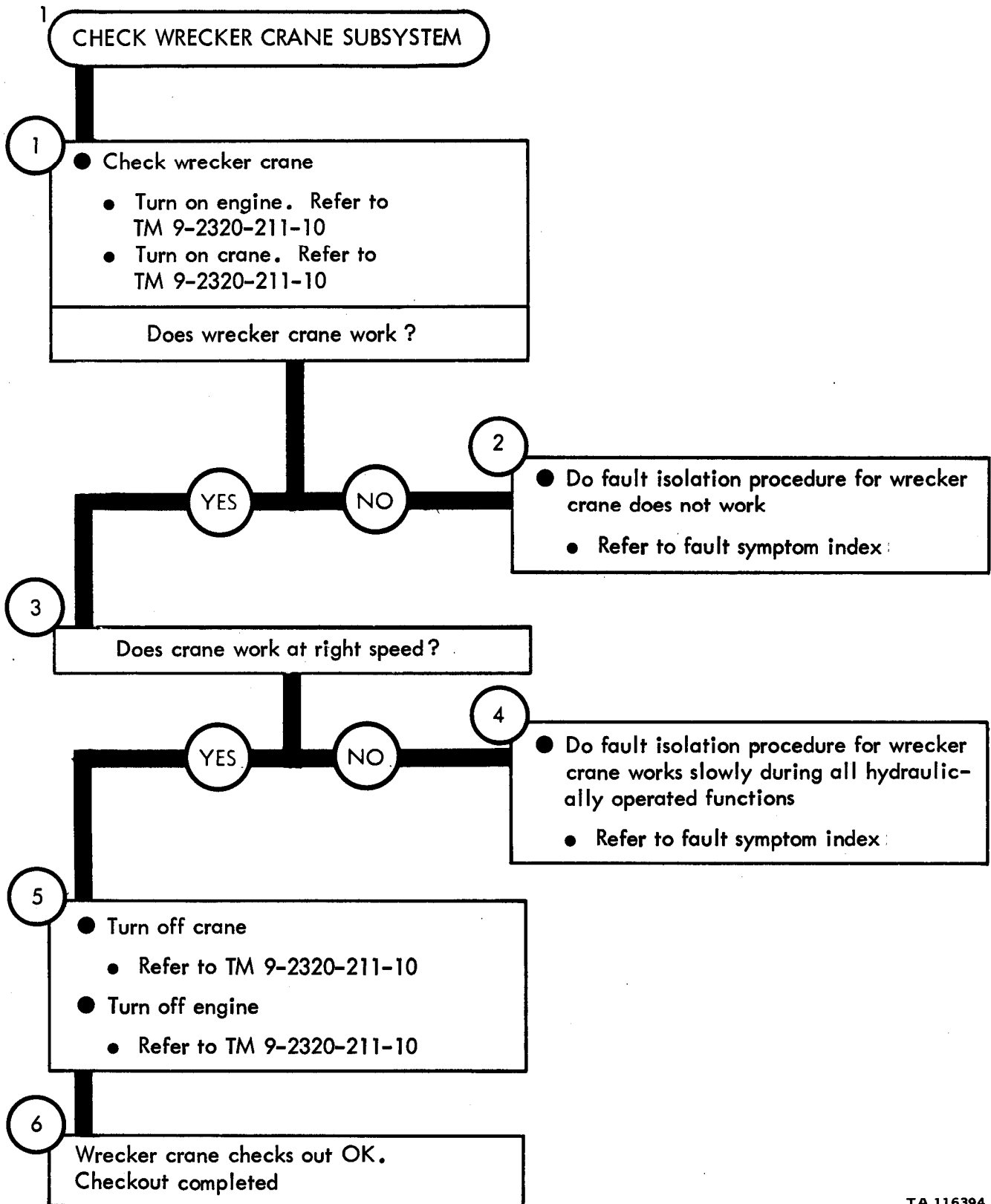

Figure 76-1

TA 116394

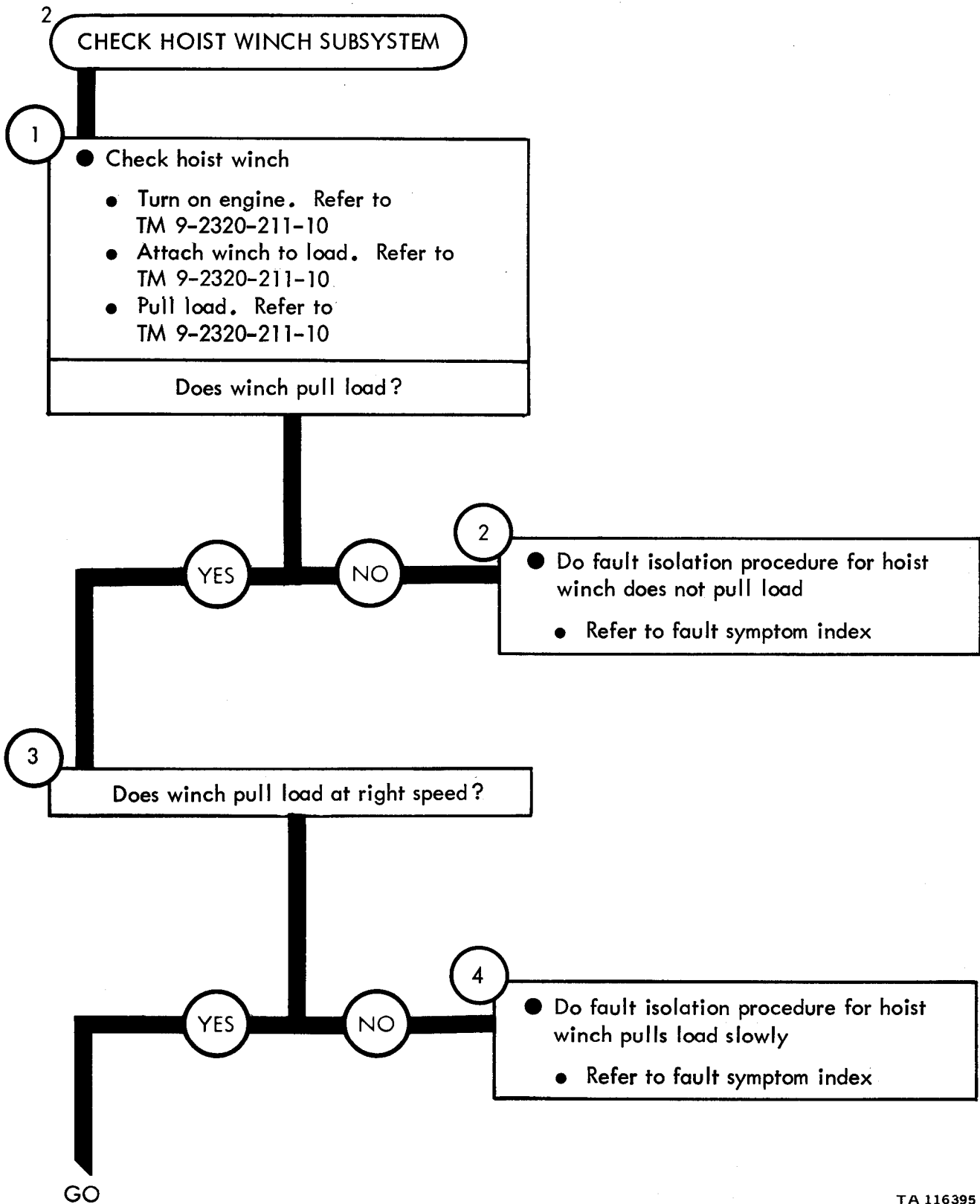

Figure 76-2 (Sheet 1 of 2)

TA 116395

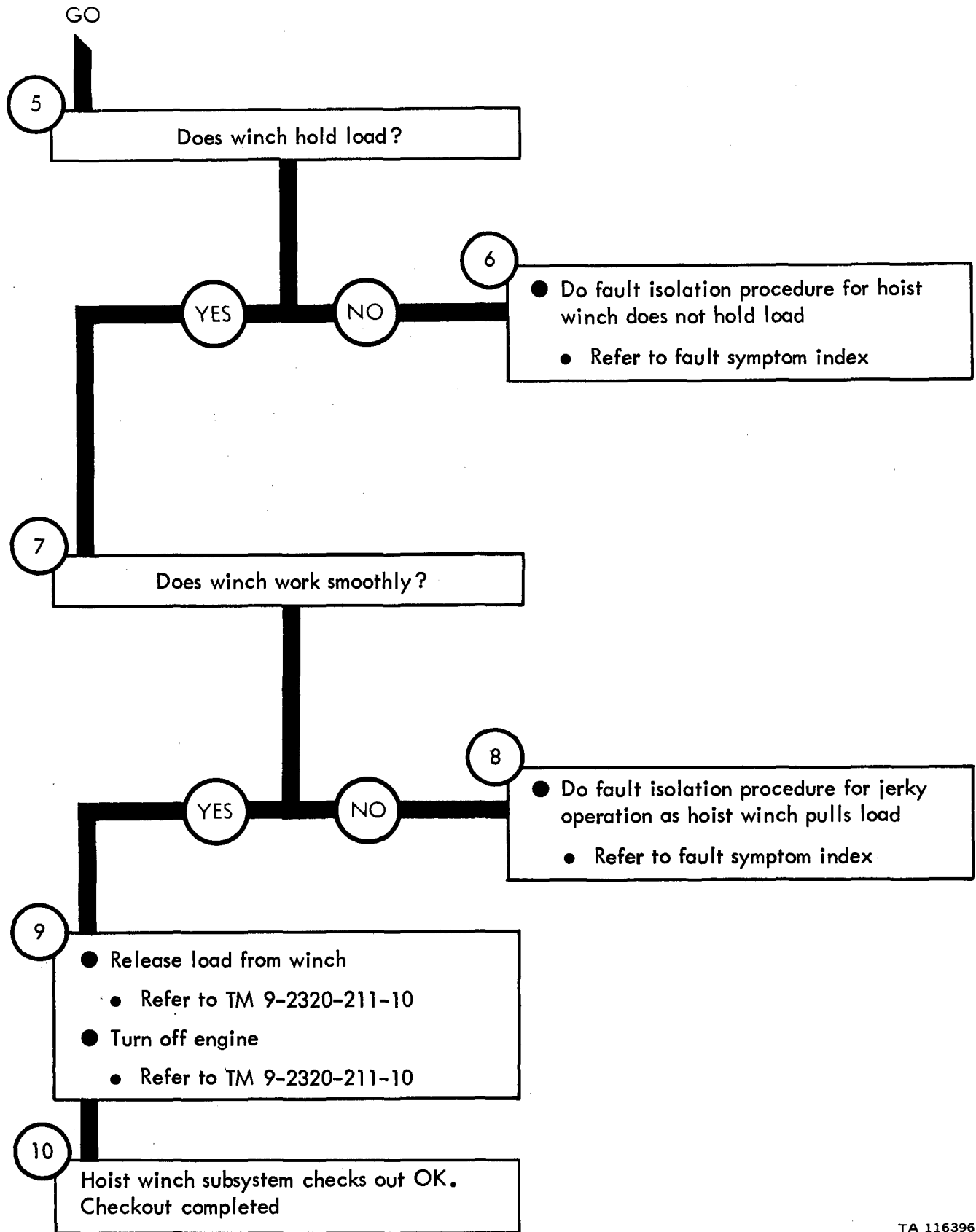

Figure 76-2 (Sheet 2 of 2)

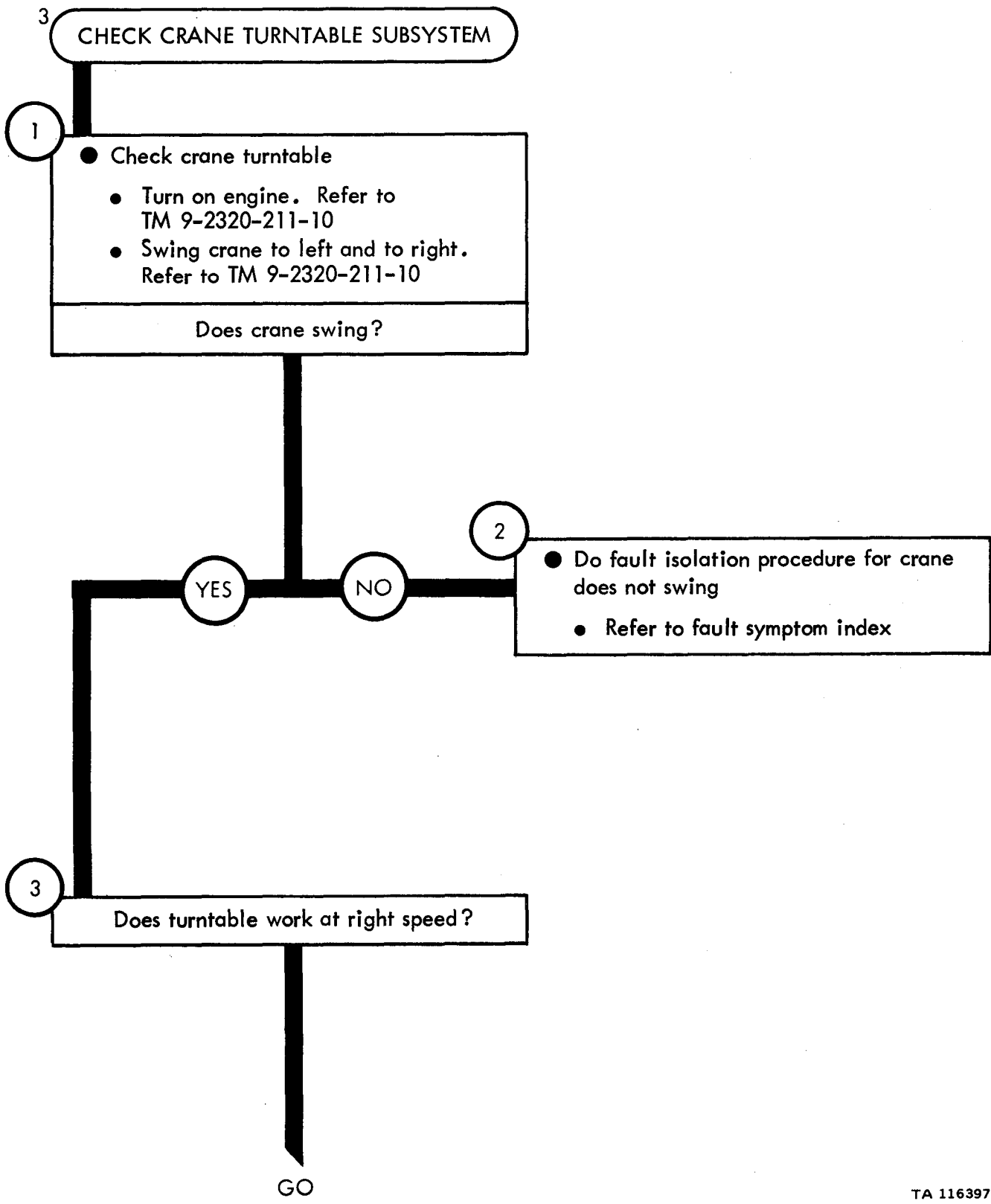

Figure 76-3 (Sheet 1 of 2)

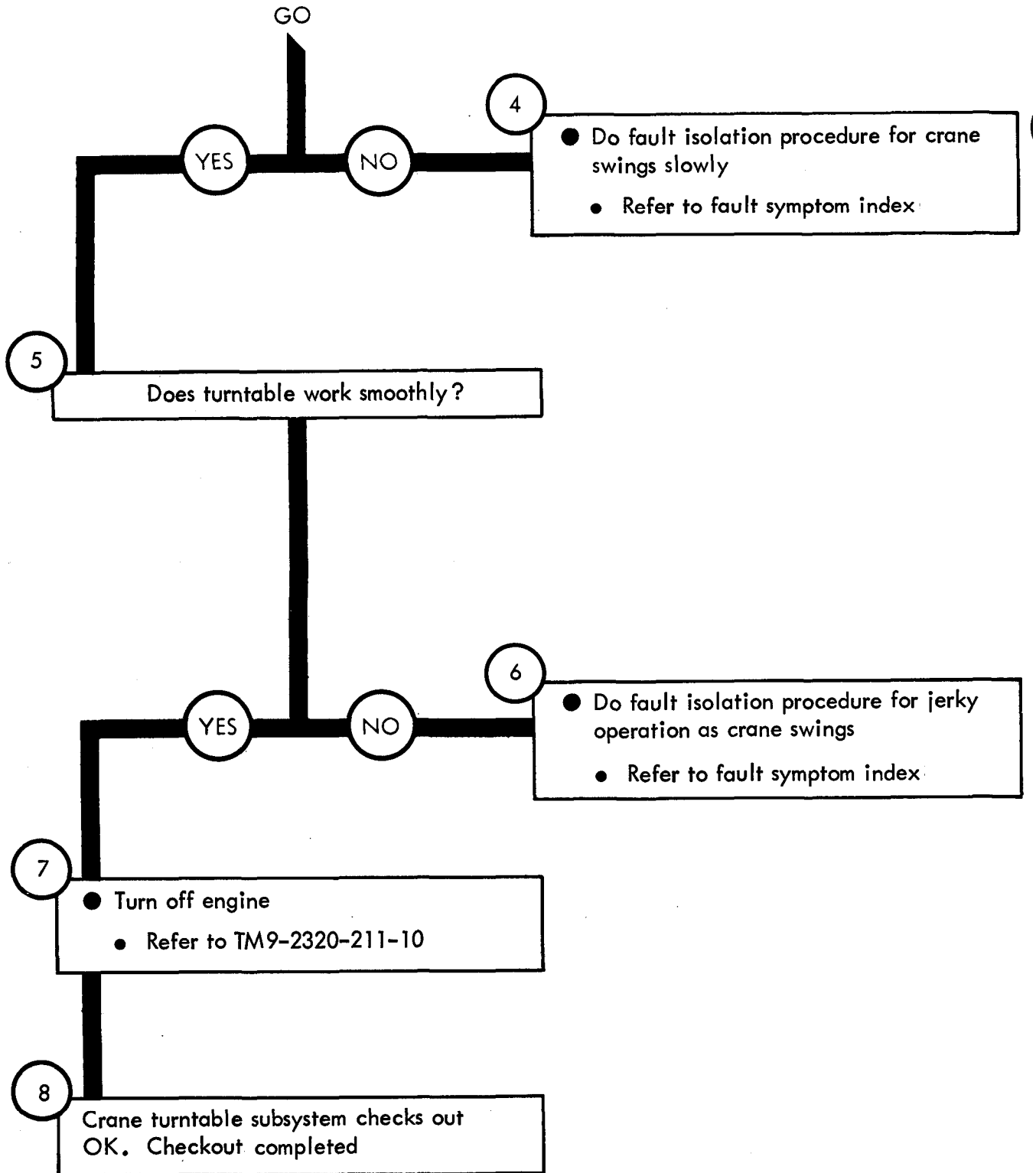

Figure 76-3 (Sheet 2 of 2)

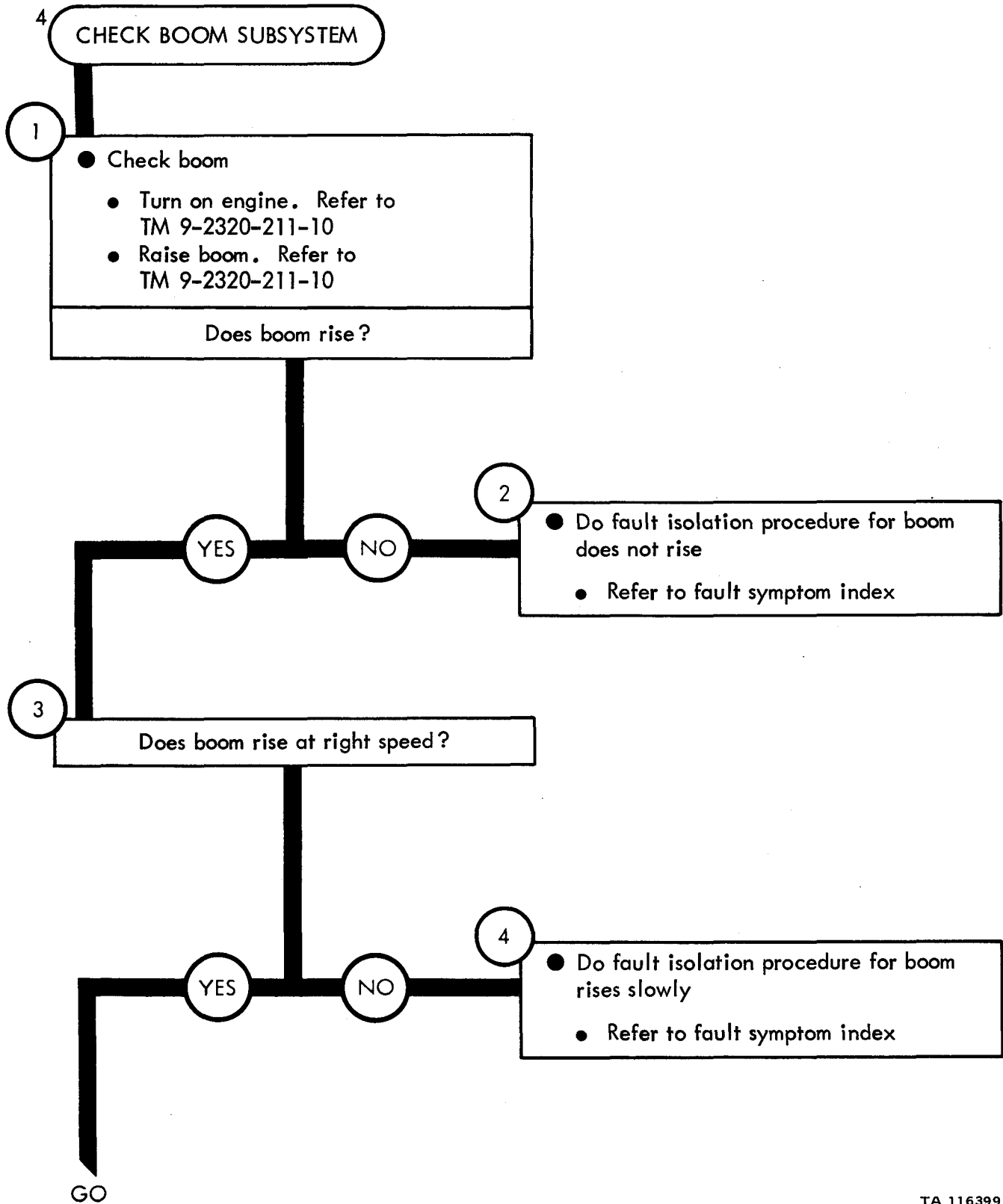

Figure 76-4 (Sheet 1 of 3)

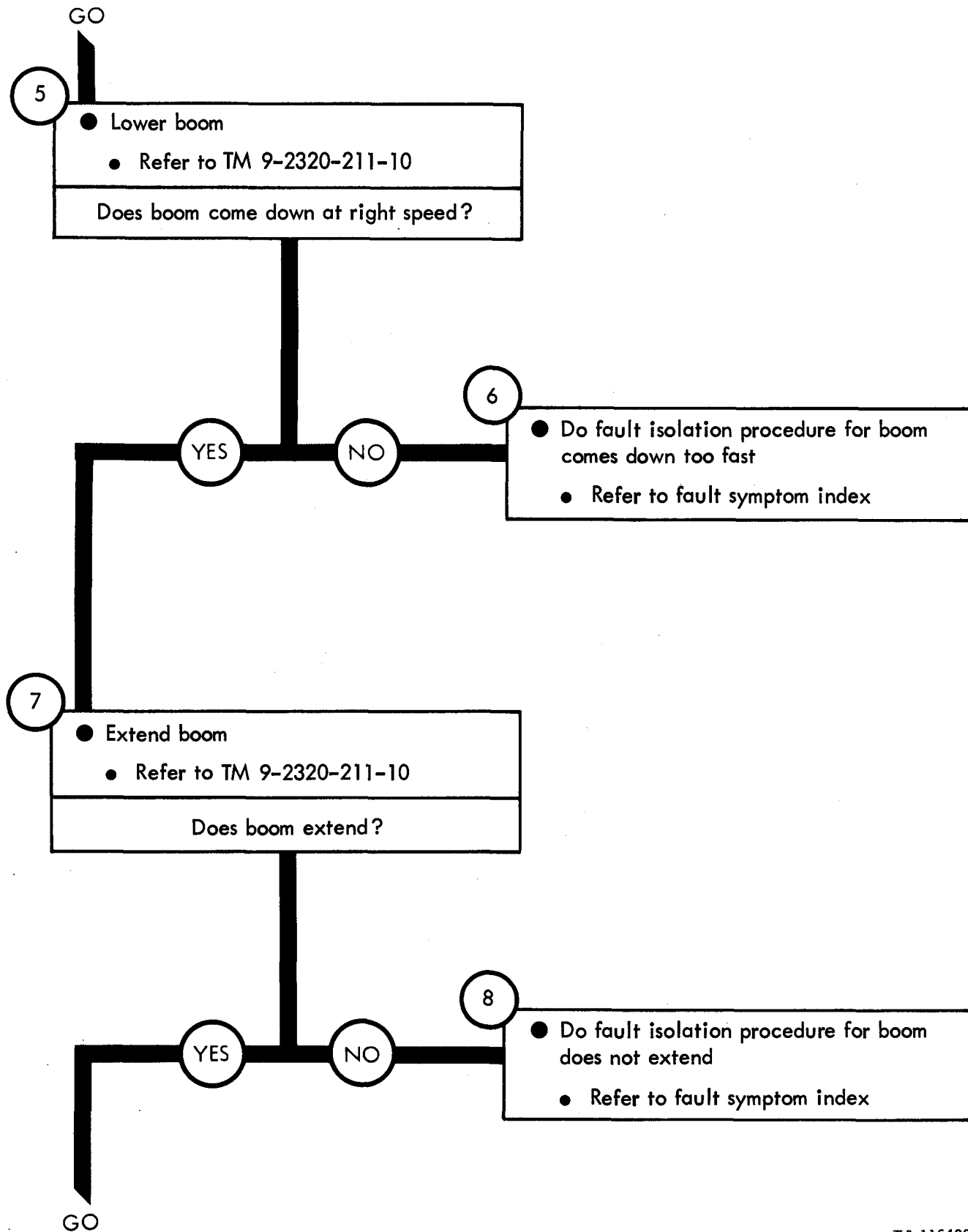

Figure 76-4 (Sheet 2 of 3)

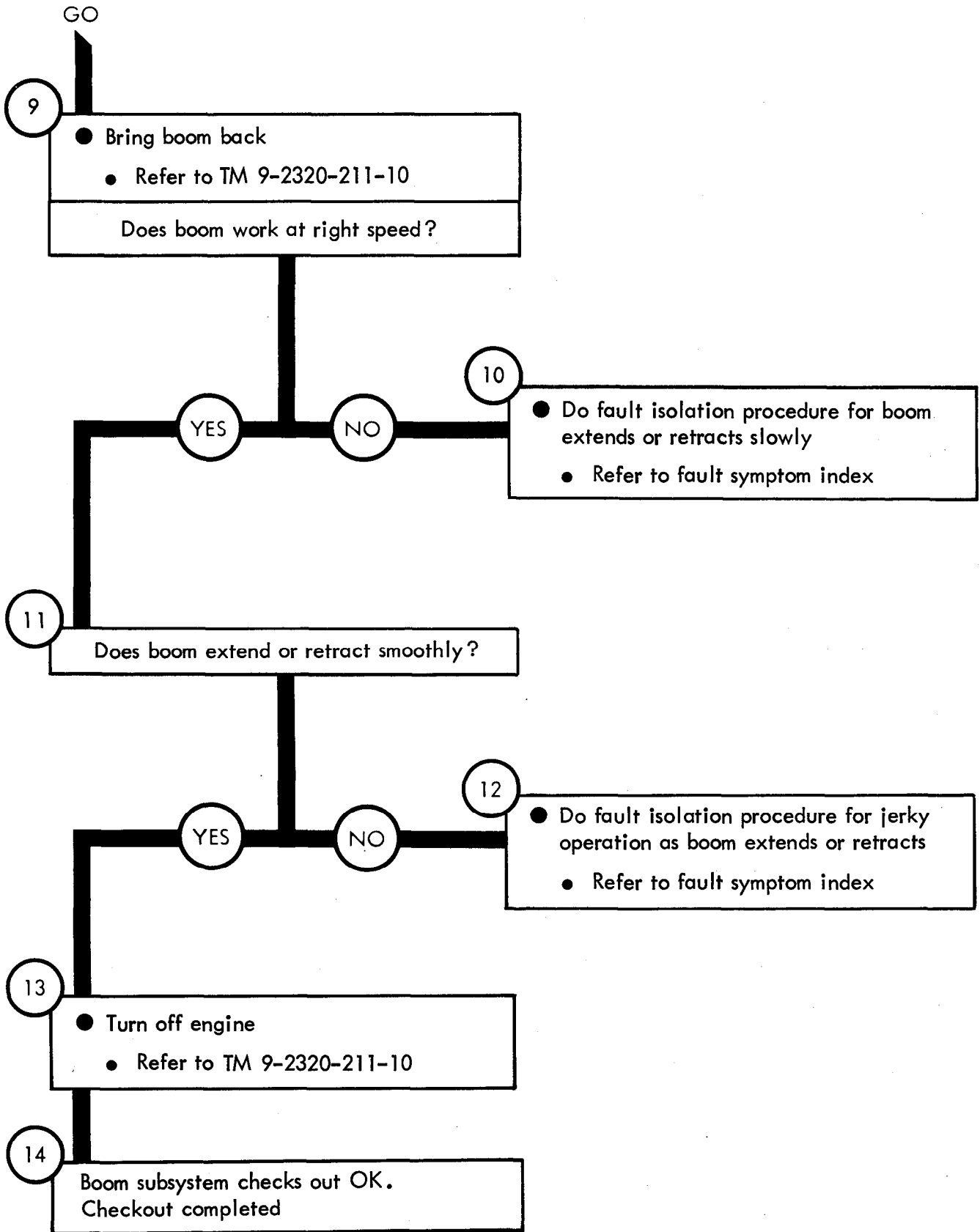

Figure 76-4 (Sheet 3 of 3)

TA 116401

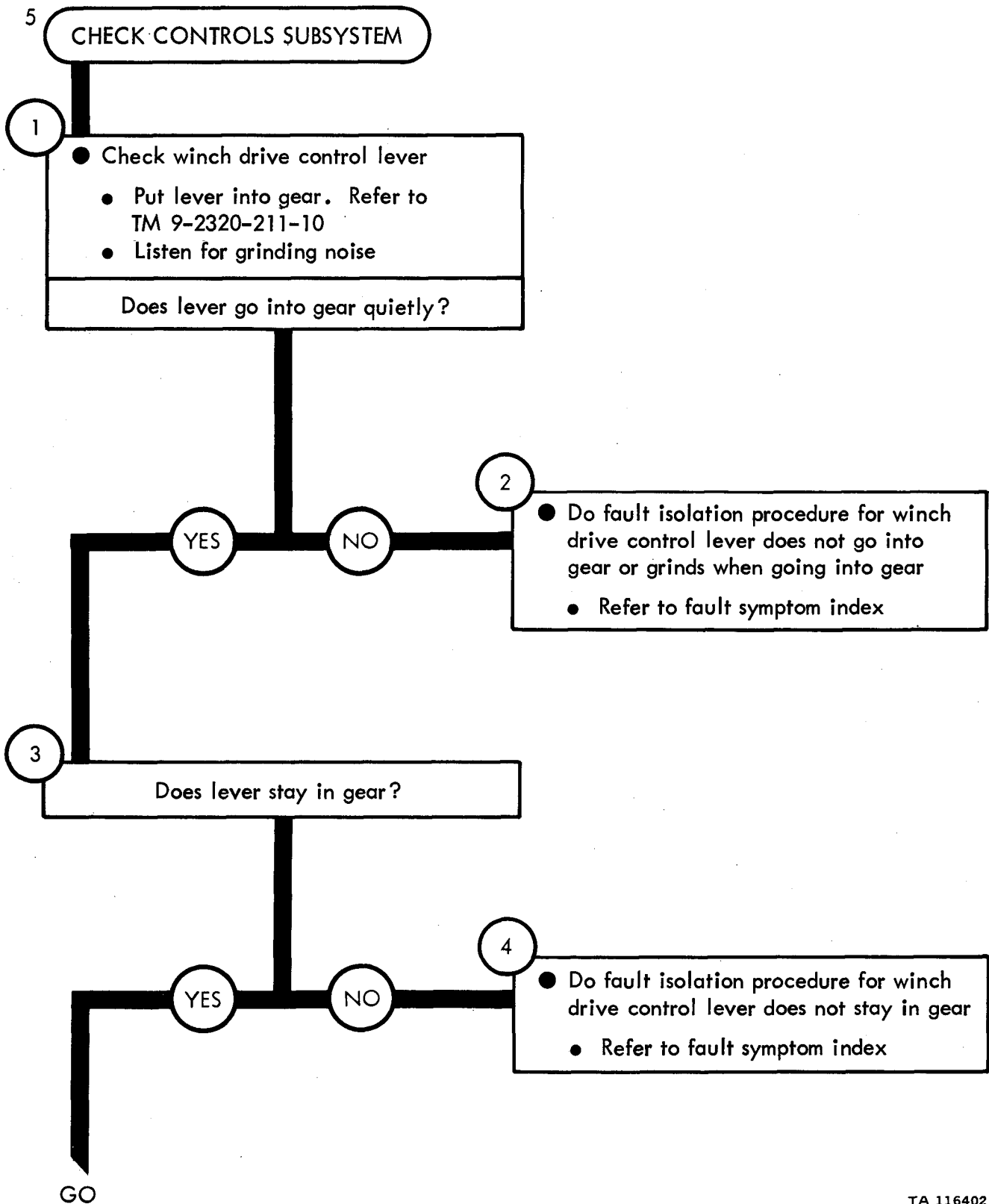

Figure 76-5 (Sheet 1 of 3)

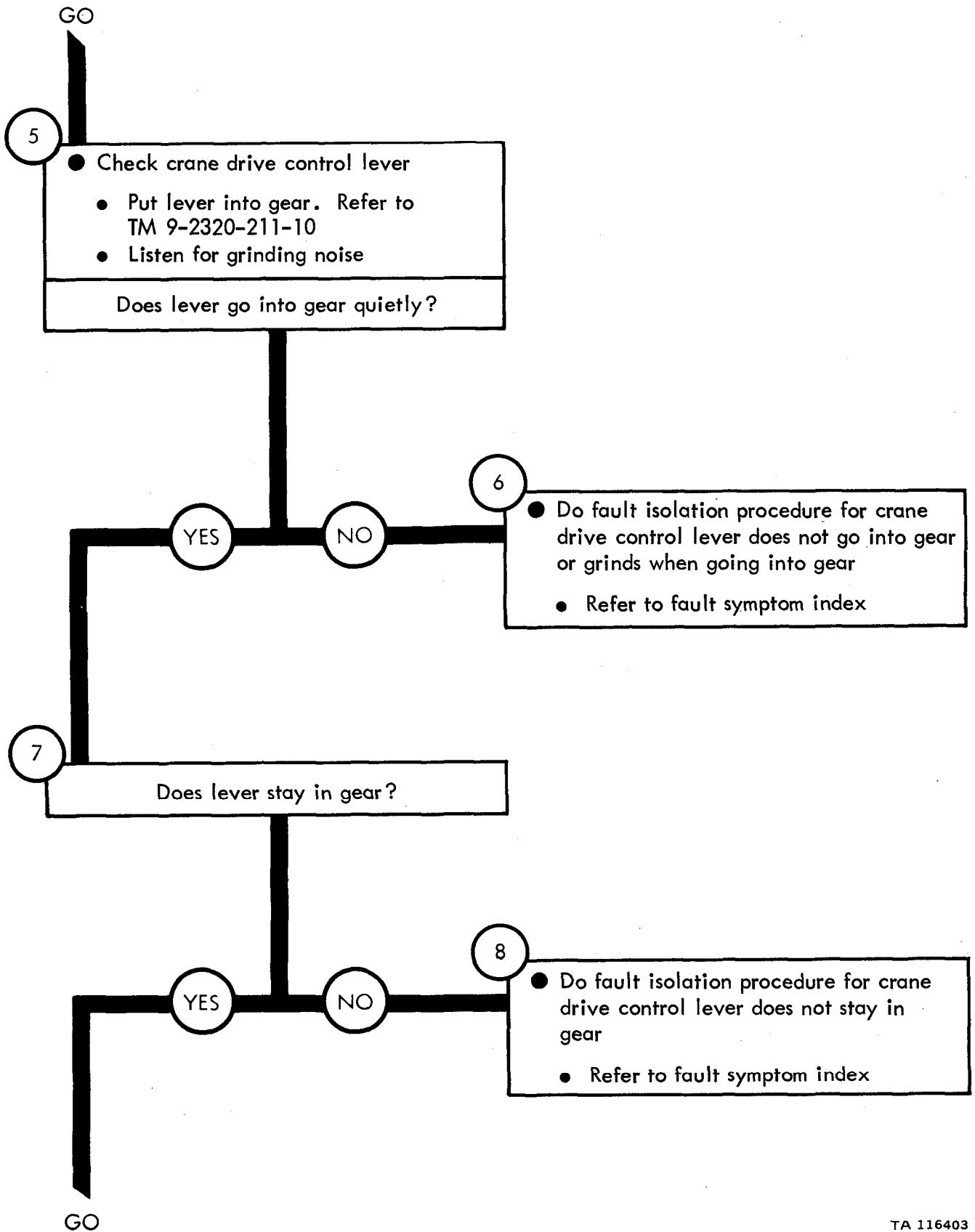

Figure 76-5 (Sheet 2 of 3)

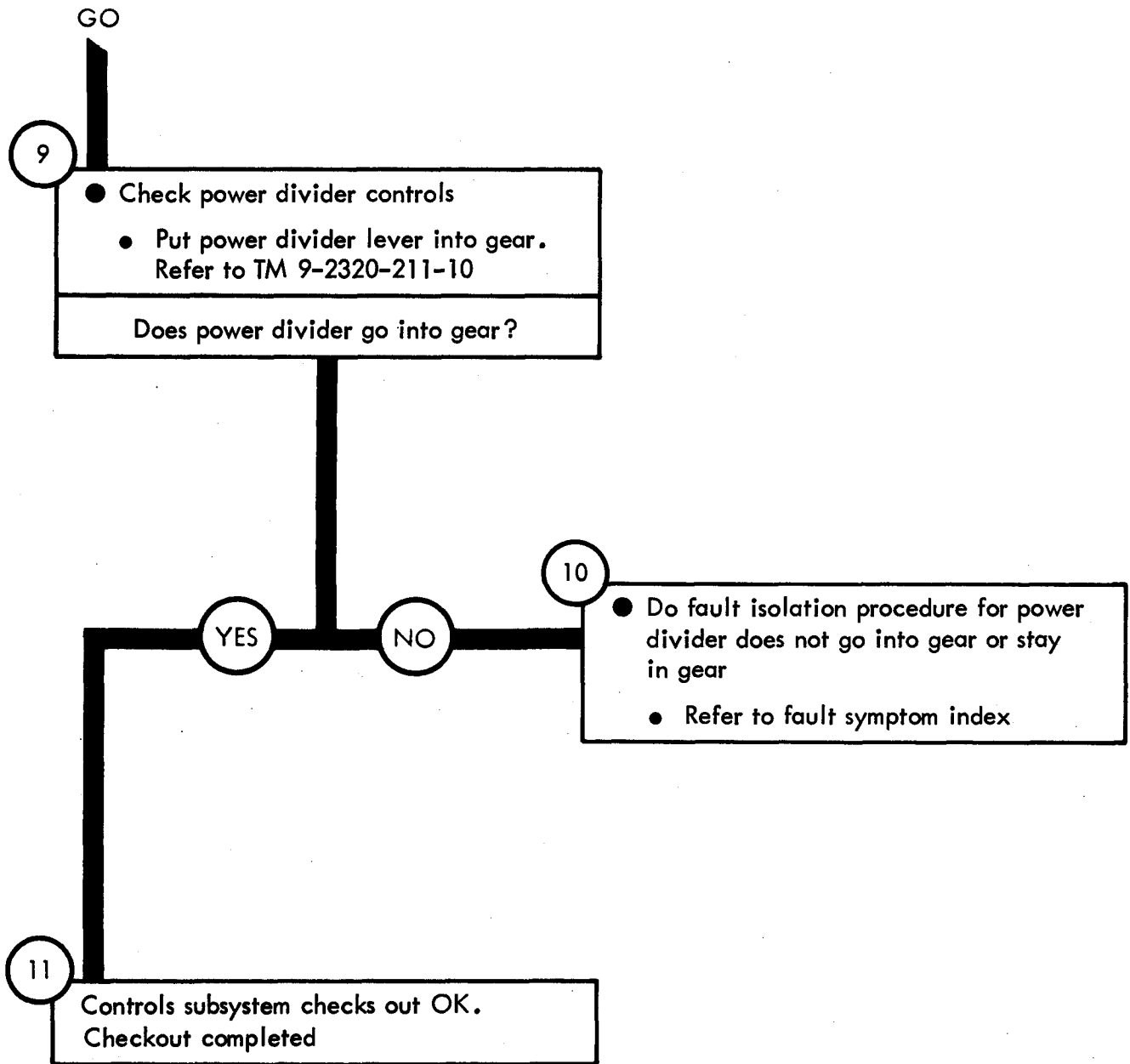

Figure 76-5 (Sheet 3 of 3)

CHAPTER 77

ENGINE COOLANT HEATER SYSTEM TROUBLESHOOTING

77-1. EQUIPMENT ITEMS COVERED . This chapter gives equipment troubleshooting procedures for the engine coolant heater system, for which there are authorized corrective maintenance tasks at the organizational maintenance level.

77-2. EQUIPMENT ITEMS NOT COVERED. All equipment items for which corrective maintenance is authorized at the organizational maintenance level are covered in this chapter.

ENGINE COOLANT HEATER SYSTEM TROUBLESHOOTING

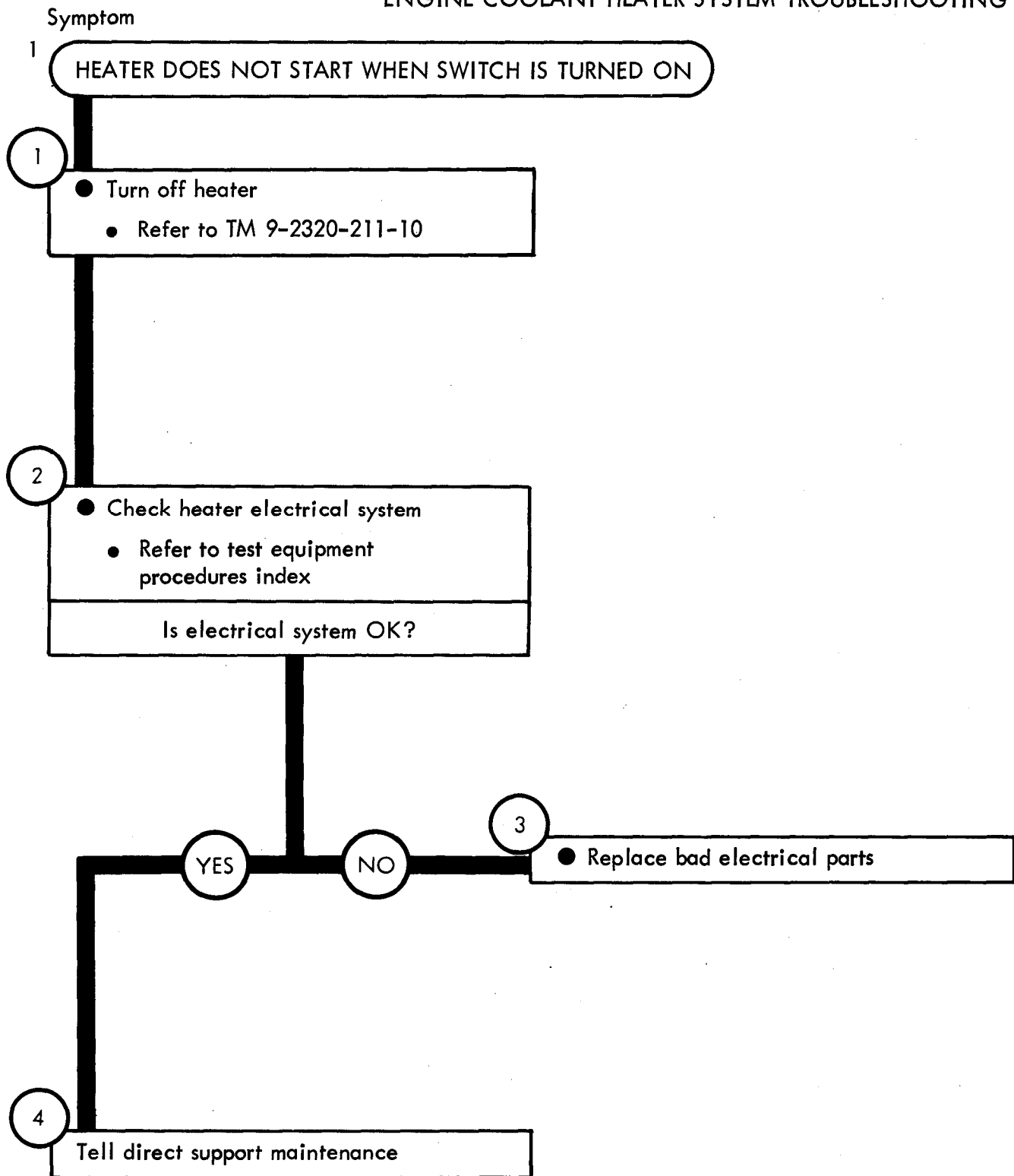

Figure 77-1

Symptom

2 HEATER WORKS FOR SEVERAL MINUTES THEN STOPS

- 1
- Turn off heater
 - Refer to procedures given in TM 9-2320-211-10

WARNING

Diesel fuel is very flammable. Care must be used when choosing a place to work on engine coolant heater system. Keep truck about 50 feet away from an area where open flame, sparks, or smoking may cause a fire. Keep a fire extinguisher close by

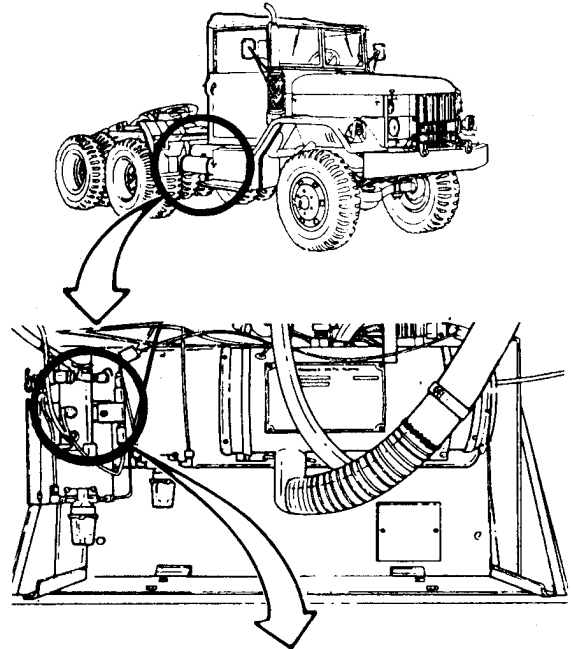

- 2
- Check heater fuel lines
 - Look for crushed or kinked fuel lines
- Are fuel lines OK?

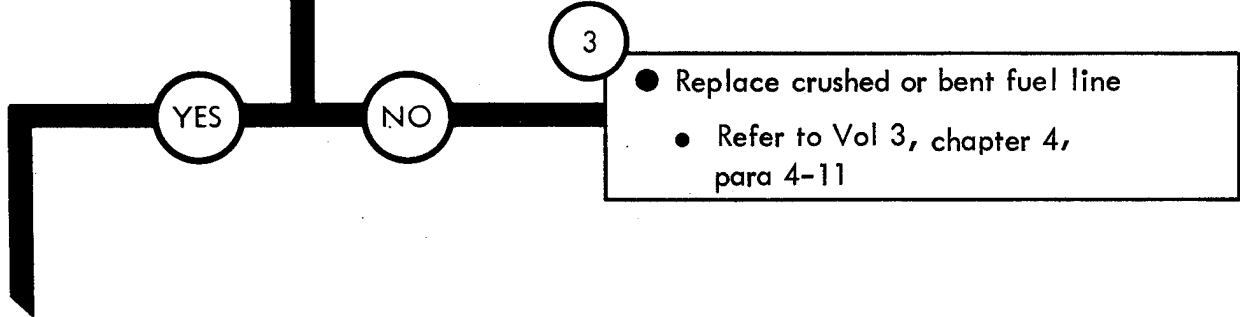
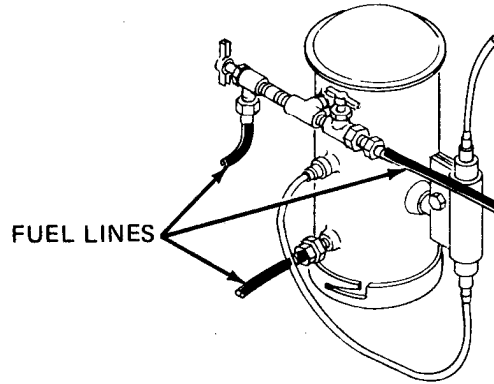

Figure 77-2 (Sheet 1 of 3)

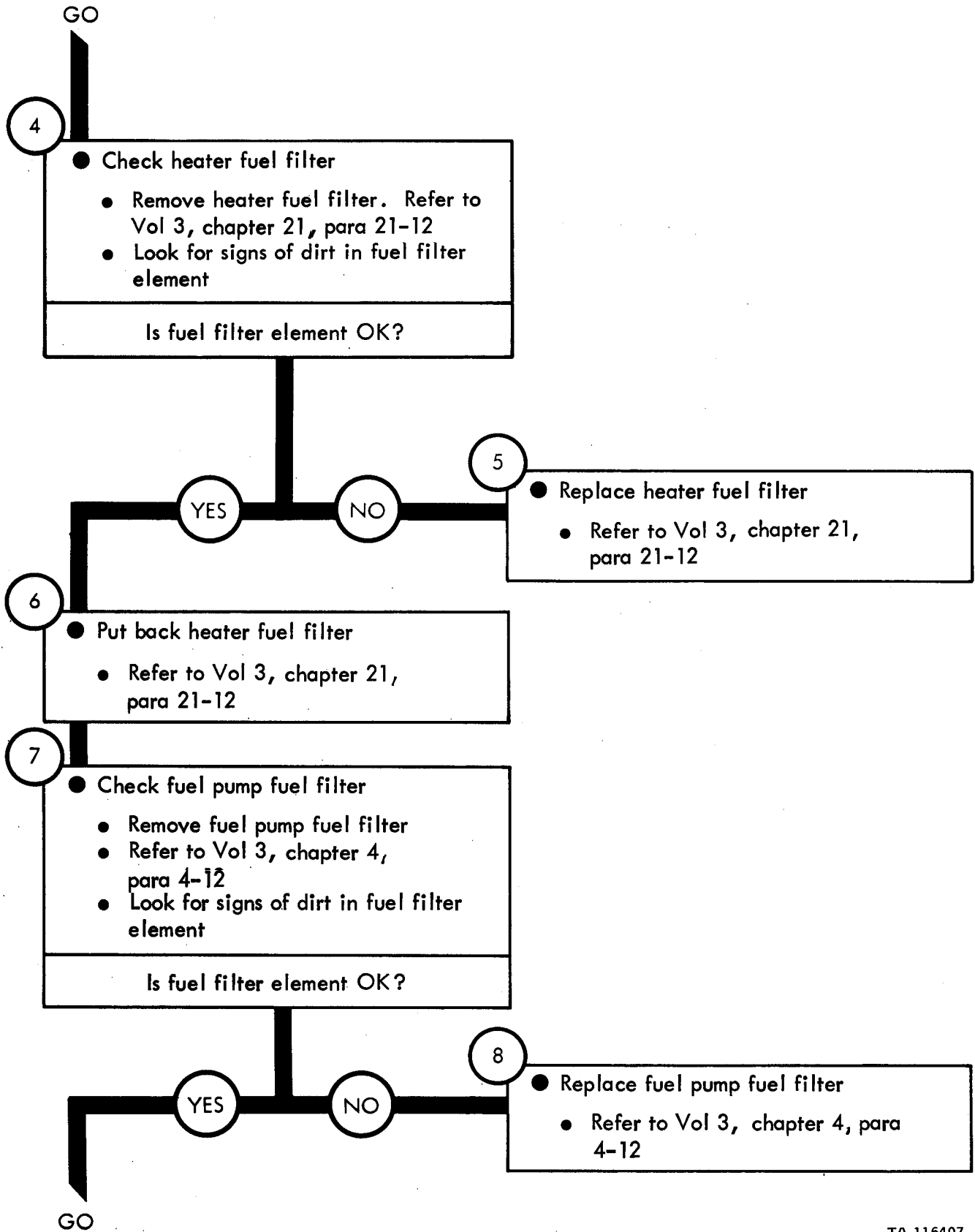

Figure 77-2 (Sheet 2 of 3)

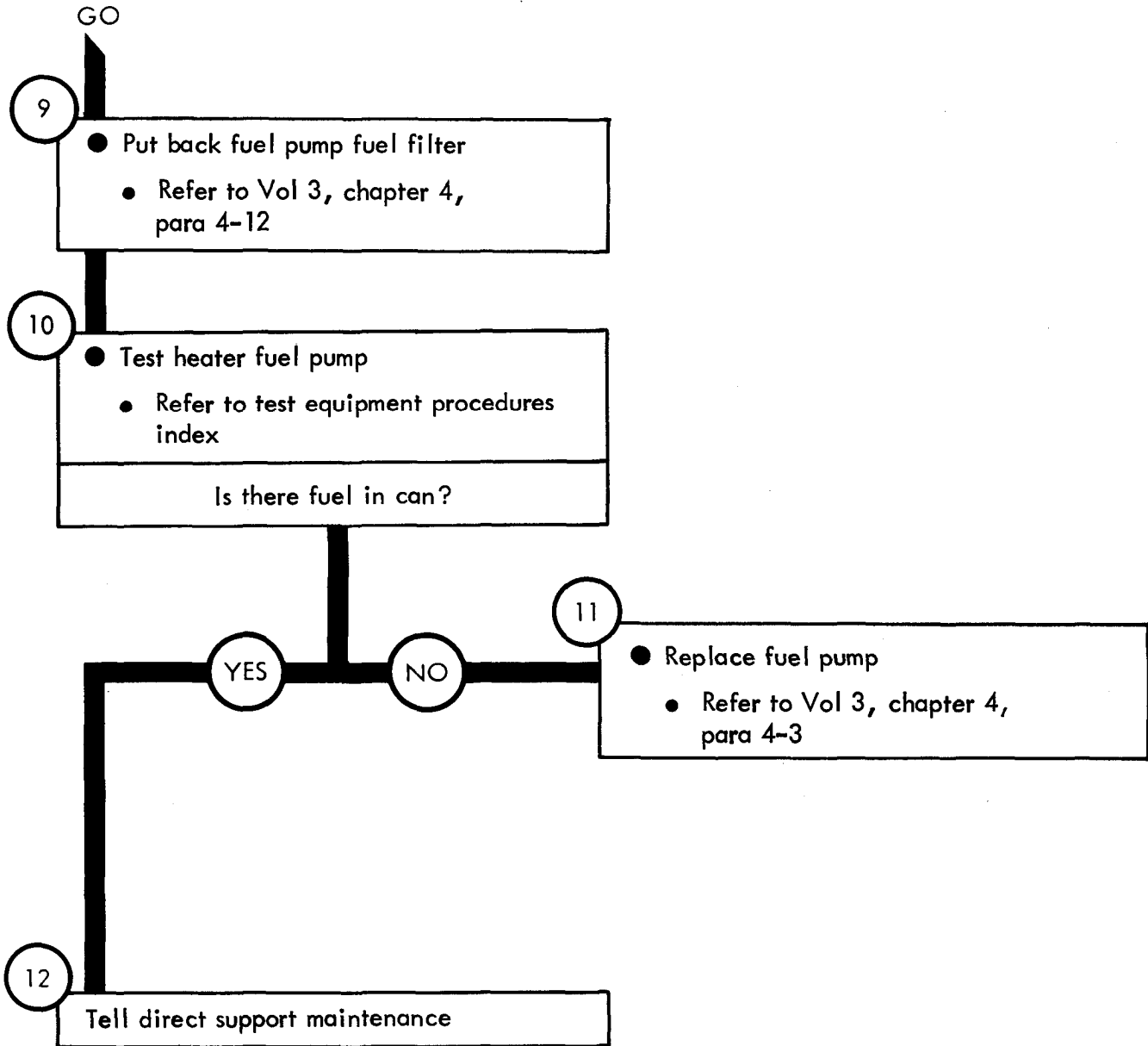

Figure 77-2 (Sheet 3 of 3)

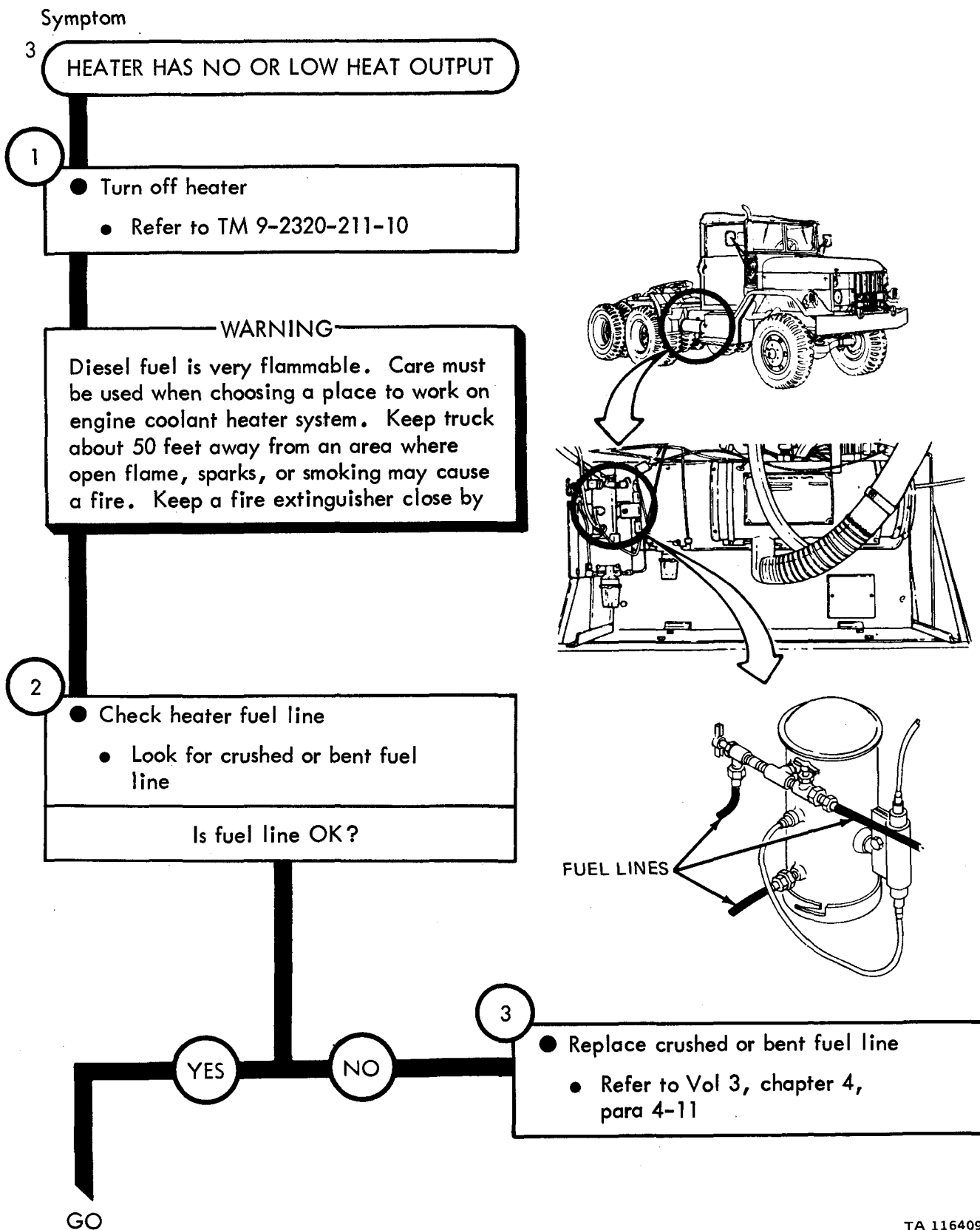

Figure 77-3 (Sheet 1 of 3)

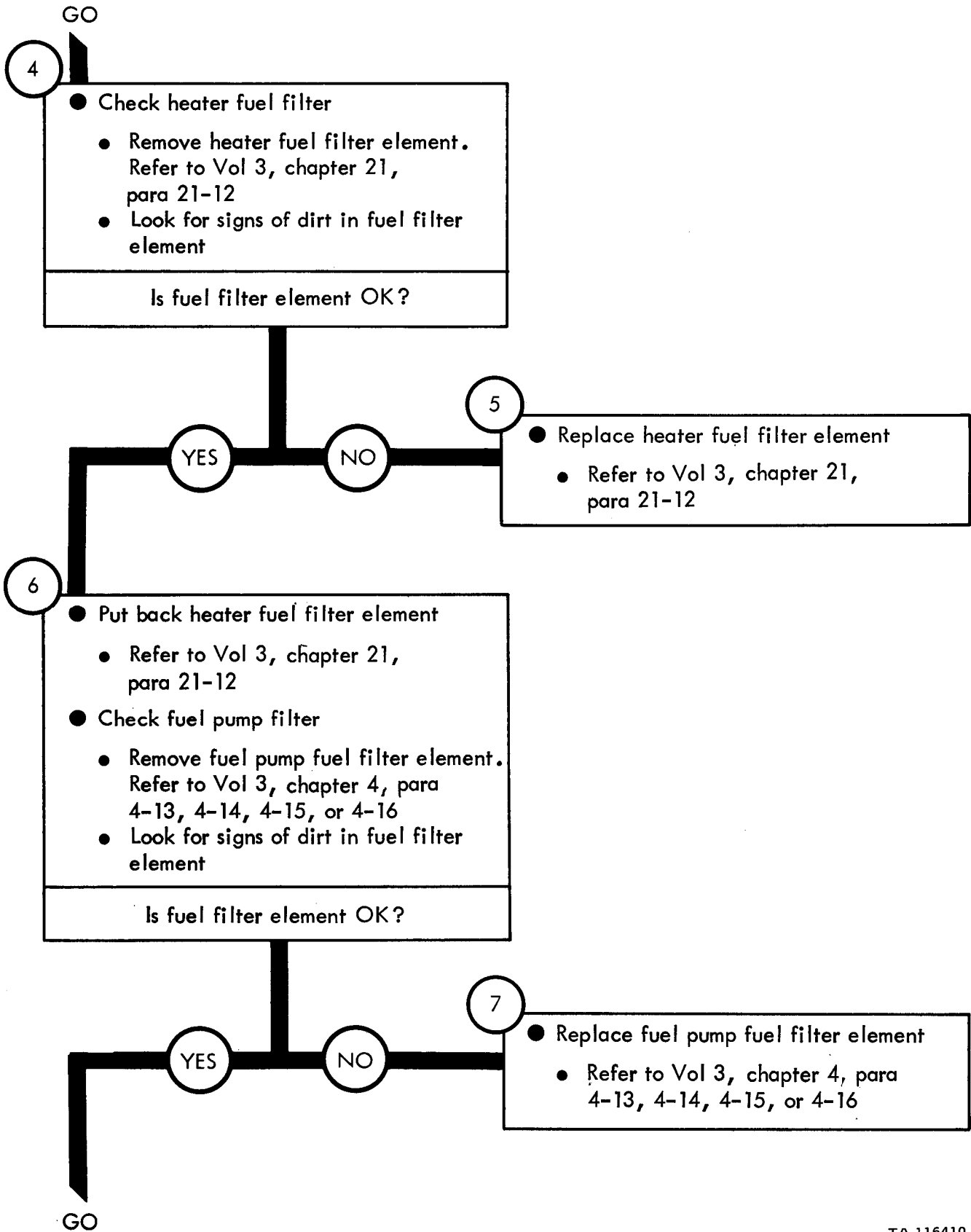
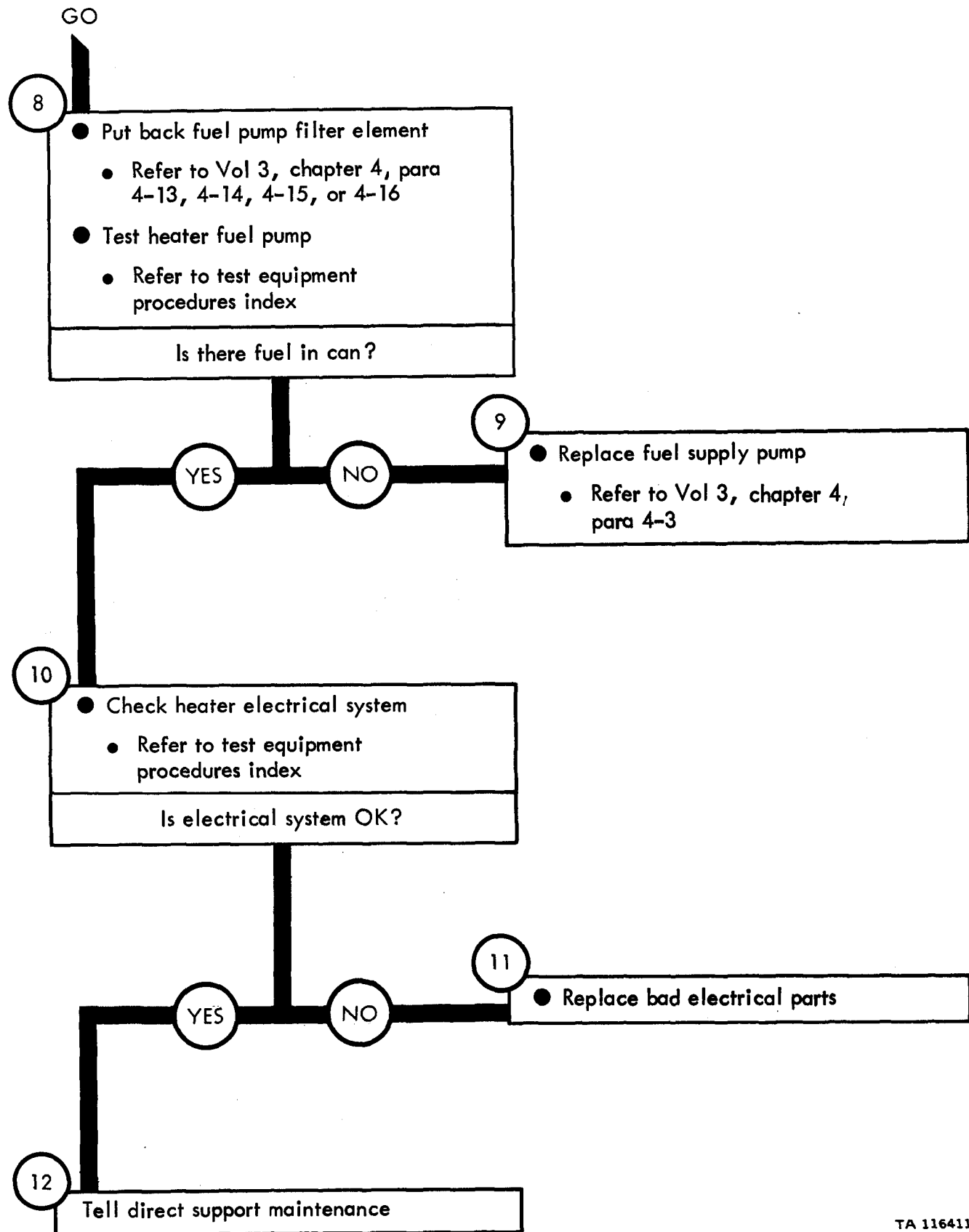

Figure 77-3 (Sheet 2 of 3)



TA 116411

Figure 77-3 (Sheet 3 Of 3)

CHAPTER 78

ENGINE COOLANT HEATER SYSTEM TROUBLESHOOTING SUMMARY

78-1. GENERAL. This chapter gives a summary of troubleshooting procedures given in chapter 77, for the Engine Coolant Heater System.

78-2. PROCEDURES. The summary in this chapter covers all fault symptoms found in the detailed troubleshooting procedures in Part 1. Chapter 7 outlines a sample troubleshooting procedure. The summary procedures are based on the "what-to-do" portions of the detailed procedures and do not include the "How-to-do-it" instructions. Warnings, cautions, and notes are given where needed.

ENGINE COOLANT HEATER SYSTEM TROUBLESHOOTING SUMMARY

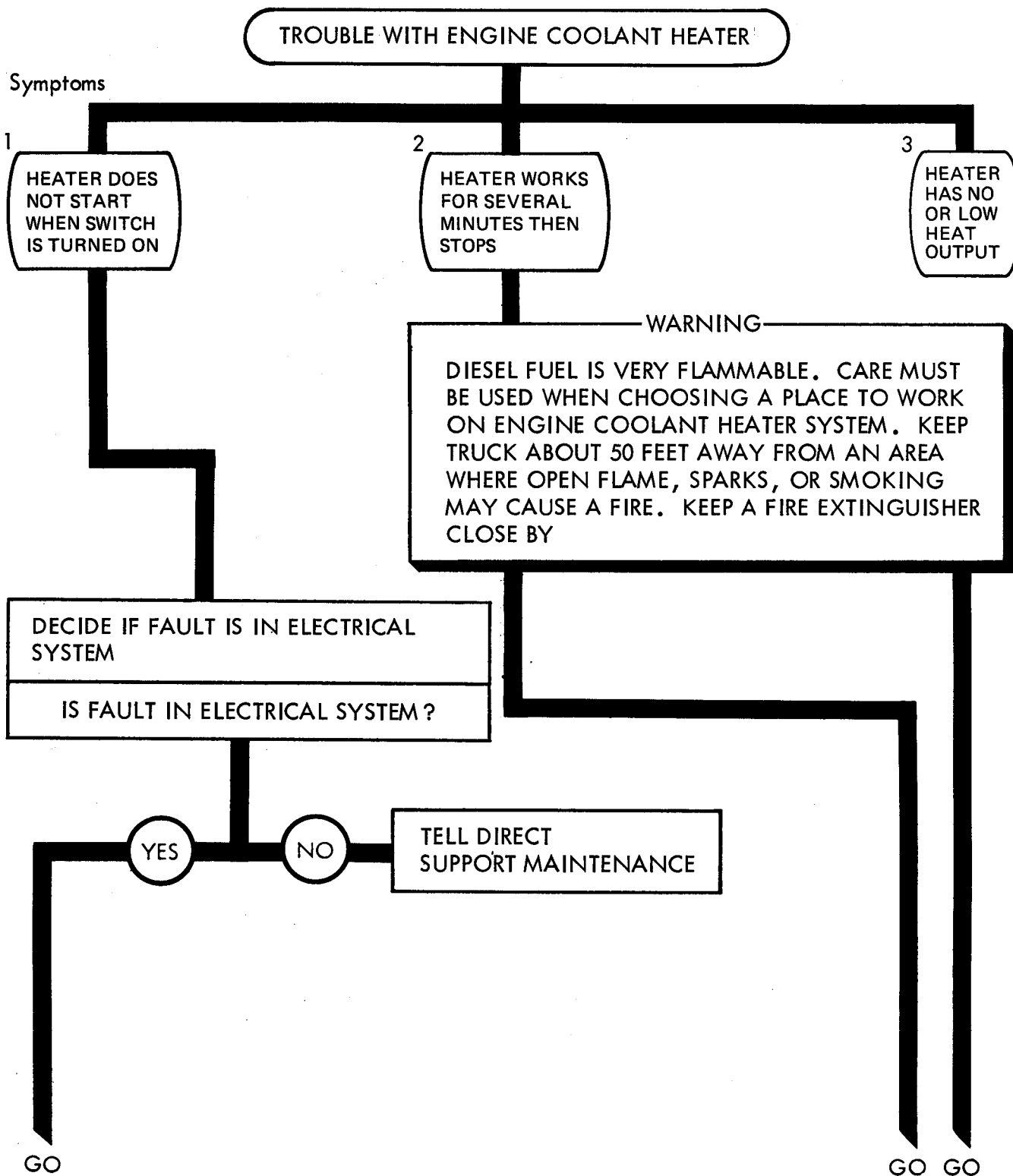

TA 116412.

Figure 78-1 (Sheet 1 of 3)

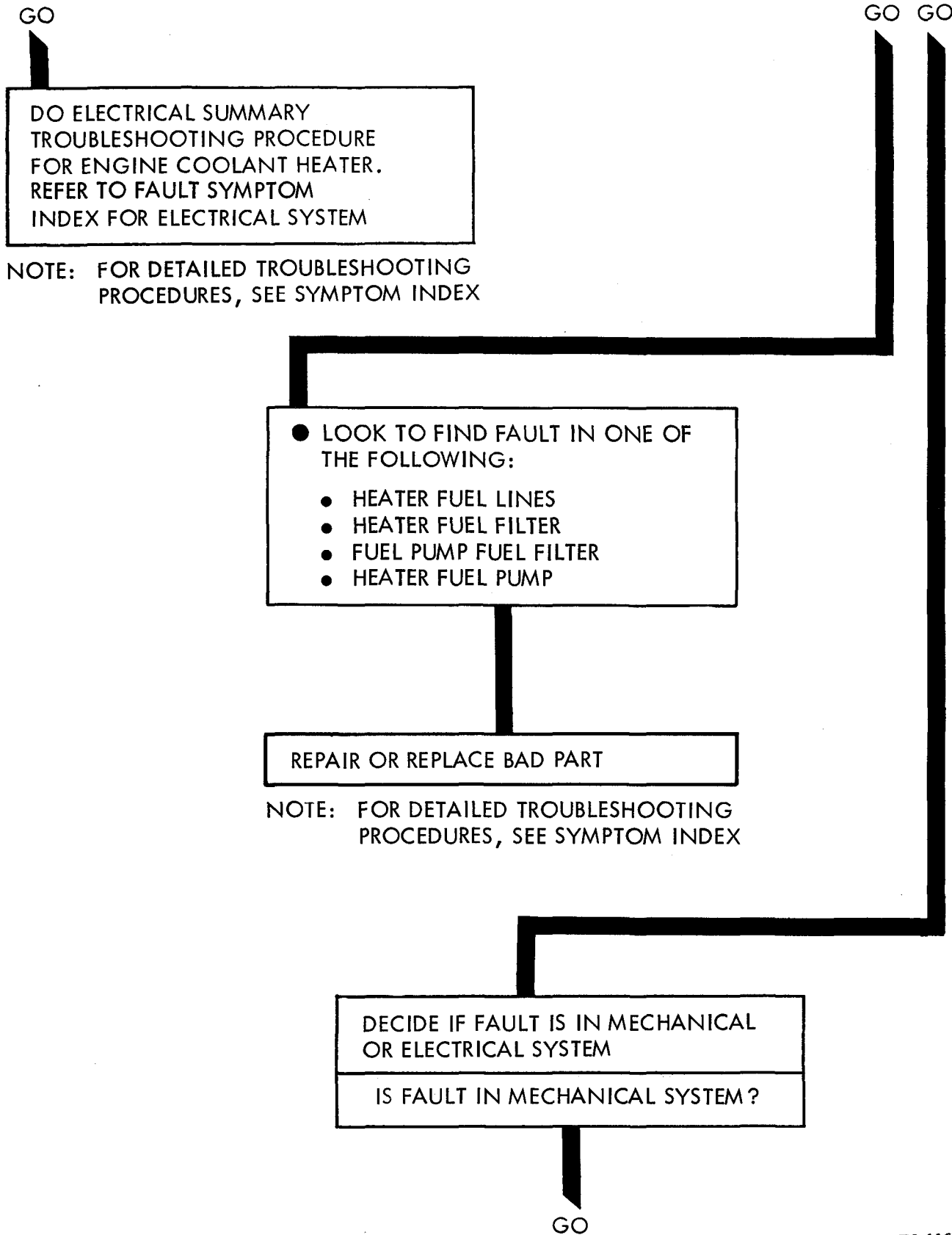

TA 116413

Figure 78-1 (Sheet 2 of 3)

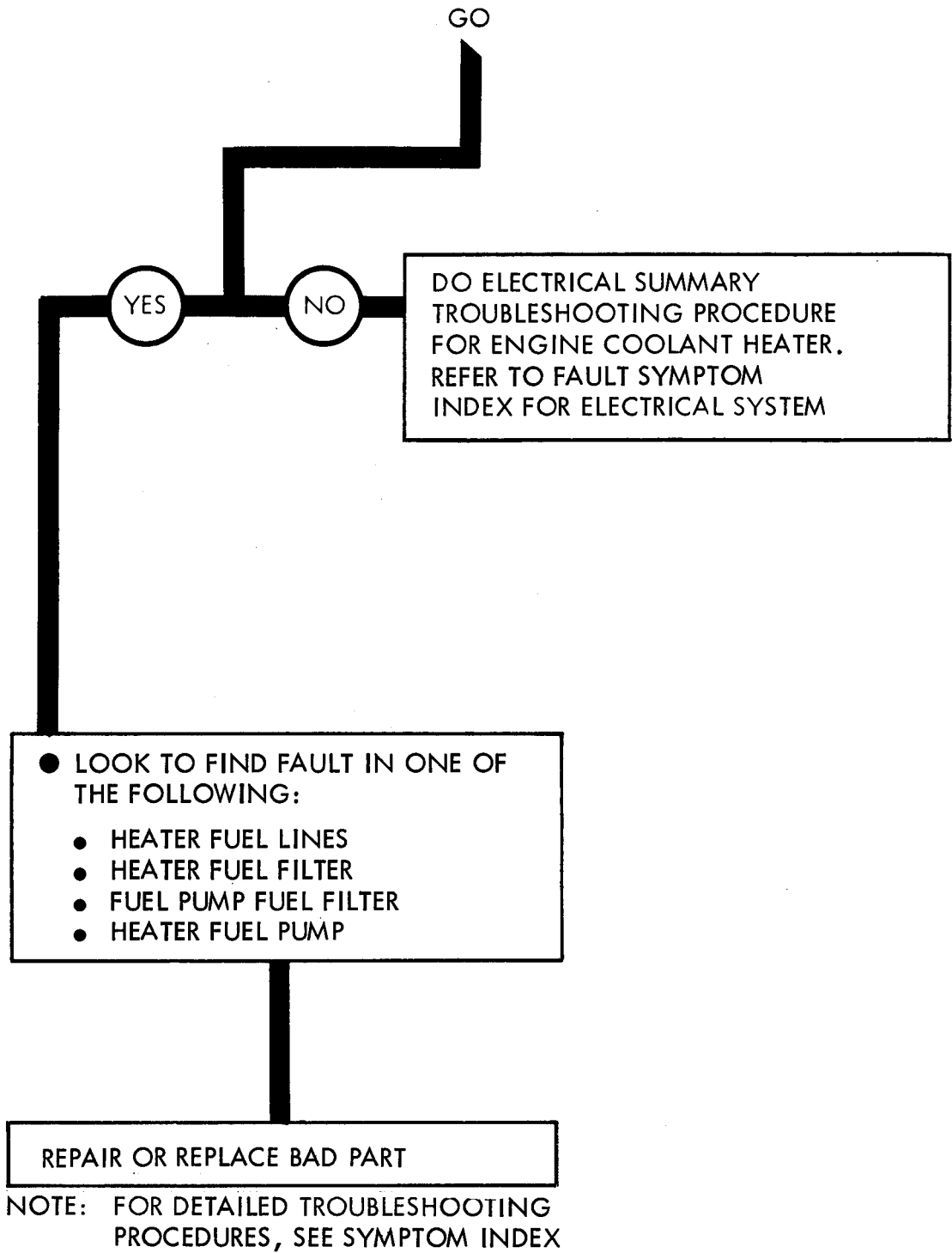

Figure 78-1 (Sheet 3 of 3)

CHAPTER 79

ENGINE COOLANT HEATER SYSTEM TEST PROCEDURES

79-1. GENERAL. This chapter gives test procedures for the tests given in chapter 77, for the Engine Coolant Heater System.

79-2. TEST SET-UP. Instructions for setup of test equipment and parts to be tested are given before the test procedures. Illustrations are used, when needed, to show you how to hook up the test equipment to the part to be tested.

79-3. TEST PROCEDURE. Detailed step-by-step instructions, in flow chart form, are given for each test. The procedure calls out the type of test and the condition of the truck system for each part of testing. The step-by-step test will lead you to the bad component or to a fault symptom within a related system. Reference is made to the fault symptom index, chapter 6, if the test shows a fault in another system.

ENGINE COOLANT HEATER SYSTEM TEST PROCEDURES

HEATER FUEL PUMP TEST

WARNING
 Diesel fuel is very flammable. Care must be used when choosing a place to work on fuel pump. Keep truck about 50 feet away from area where open flames, sparks or smoking can cause a fire. Keep a fire extinguisher close by

NOTE
 This test will need the use of two soldiers. The lead soldier will be called Soldier A and the helper will be called Soldier B

1

- Check heater fuel pump
- SOLDIER A**
- Turn off fuel shutoff valve
 - Using 7/16-inch wrench unscrew fuel pump output line fitting
 - Move output line away from shutoff valve
 - Hold a can under fuel shutoff valve
 - Turn on fuel shutoff valve

GO

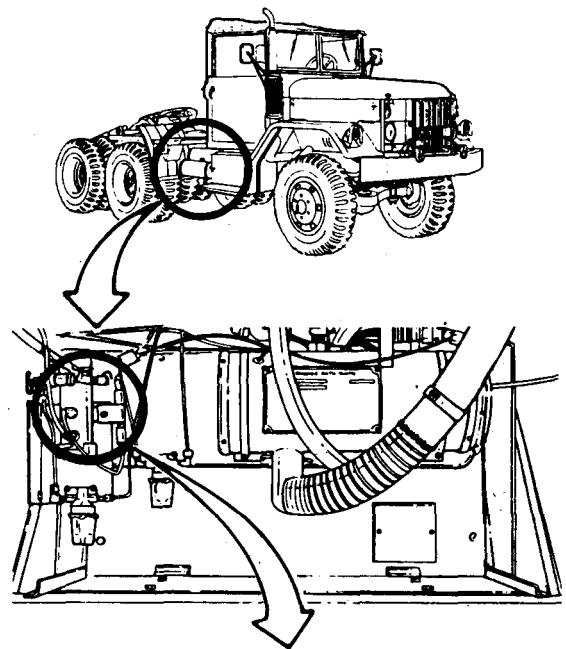

FUEL SHUTOFF VALVE

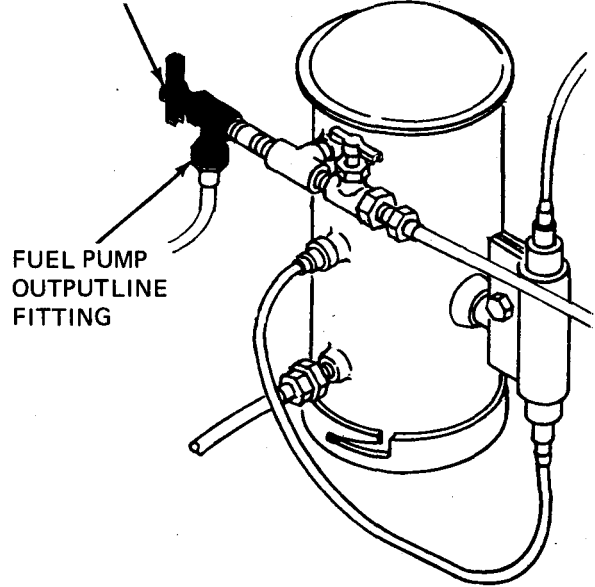

TA 116415

Figure 79-1 (Sheet 1 of 2)

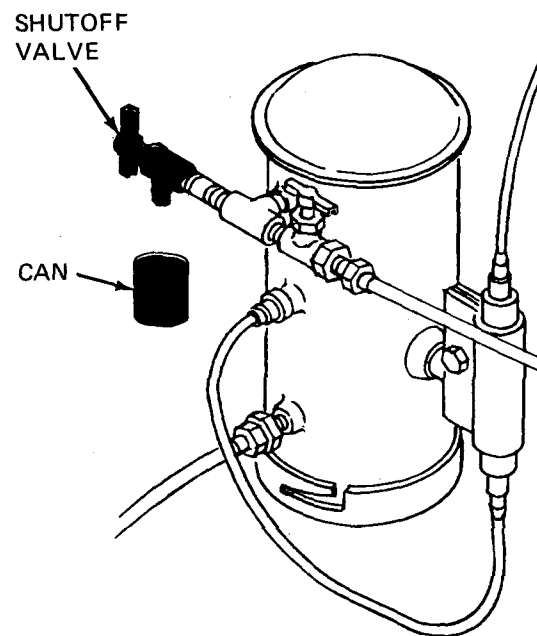
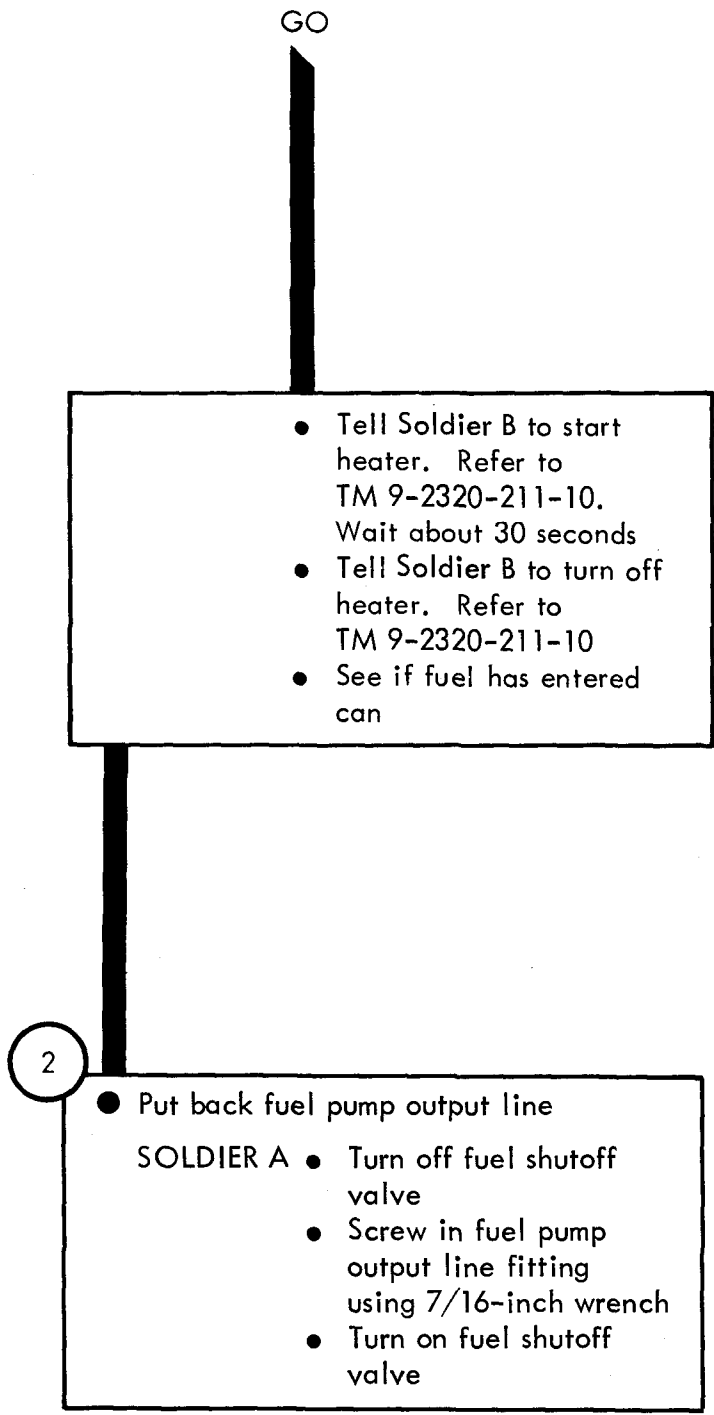

Figure 79-1 (Sheet 2 of 2)

TA 116416

79-3/79-4 (blank)

CHAPTER 80

ENGINE COOLANT HEATER SYSTEM CHECKOUT PROCEDURES

80-1. GENERAL. This chapter gives procedures for checking out the system after troubleshooting and repair have been done. Procedures are set up in flow chart form showing the checkout steps in order and referring to the fault symptom index when the system does not checkout.

ENGINE COOLANT HEATER SYSTEM CHECKOUT

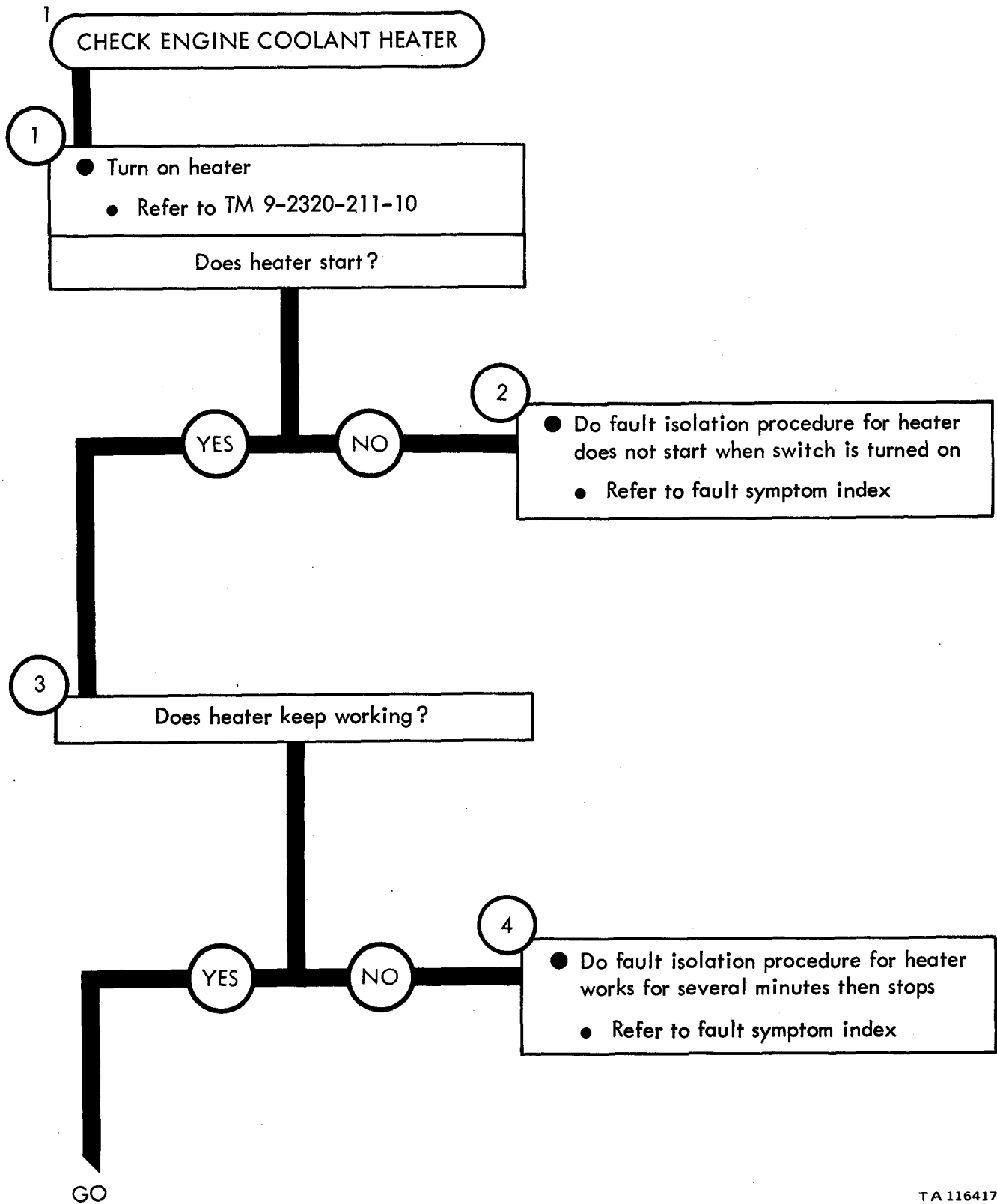
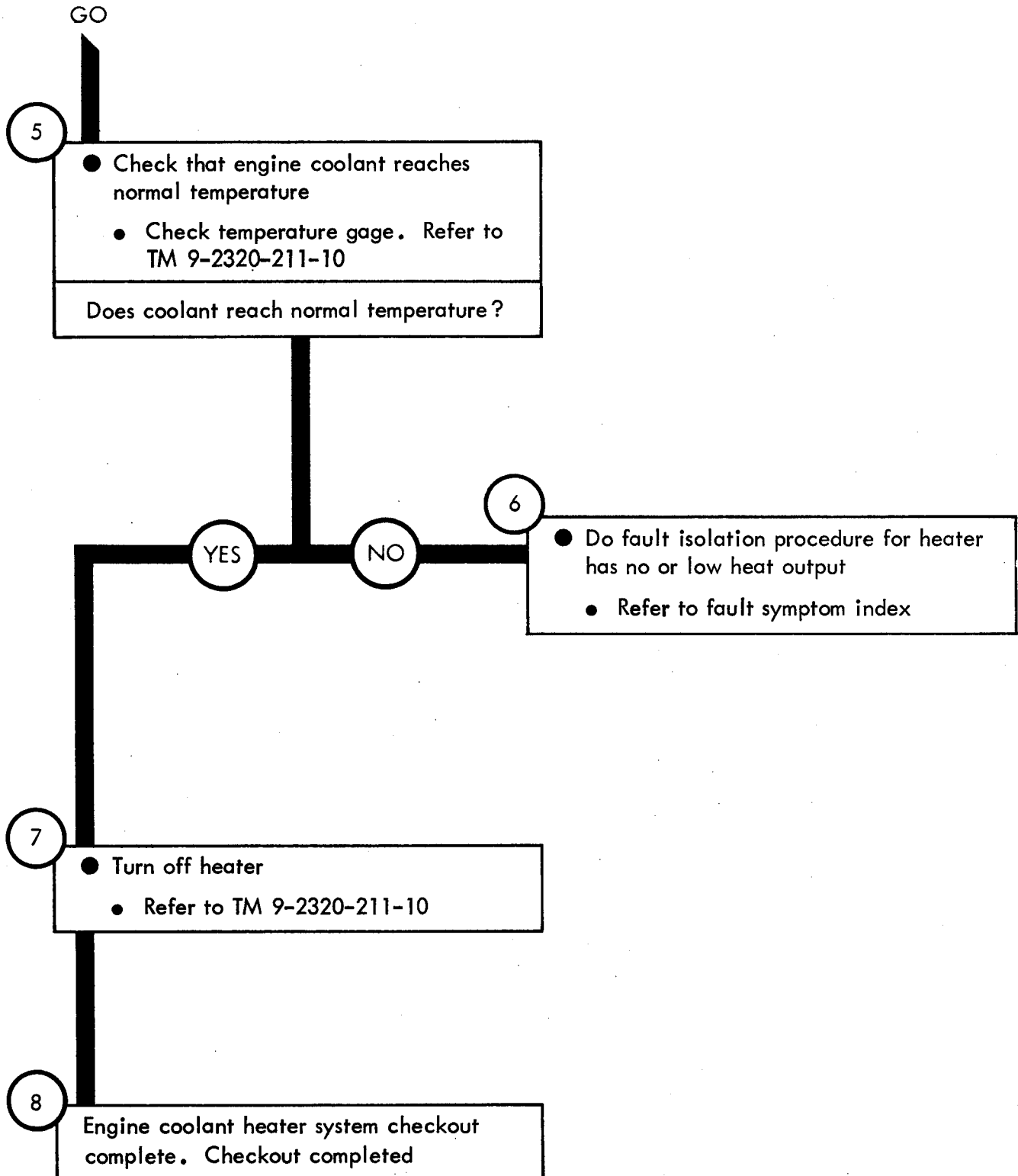

Figure 80-1 (Sheet 1 of 2)



CHAPTER 81

FUEL BURNING HEATER SYSTEM TROUBLESHOOTING

81-1. EQUIPMENT ITEMS COVERED. This chapter gives equipment troubleshooting procedures for the fuel burning heater system, for which there are authorized corrective maintenance tasks at the organizational maintenance level.

81-2. EQUIPMENT ITEMS NOT COVERED . All equipment items for which corrective maintenance is authorized at the organizational maintenance level are covered in this chapter.

FUEL BURNING HEATER SYSTEM TROUBLESHOOTING

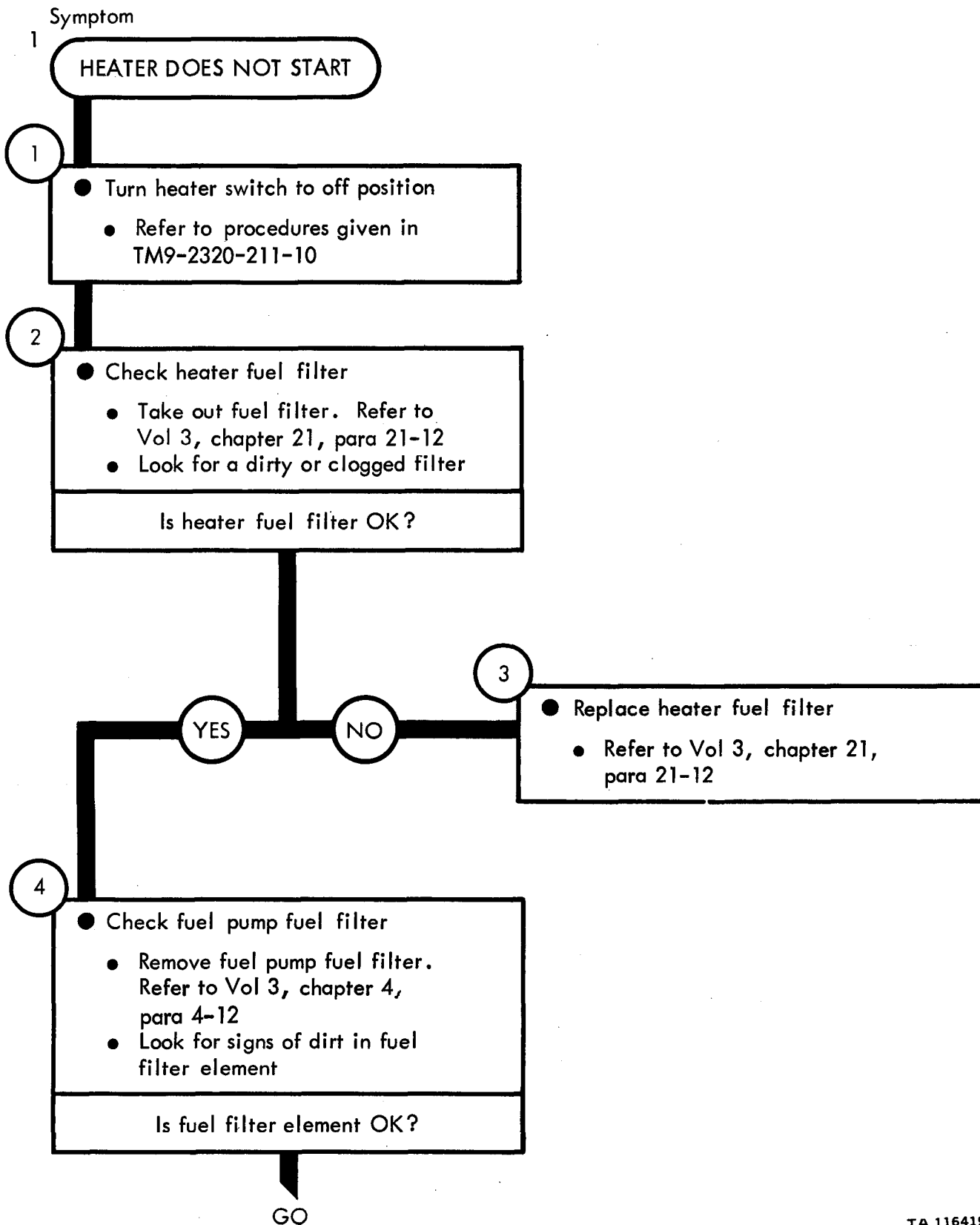

Figure 81-1 (Sheet 1 of 2)

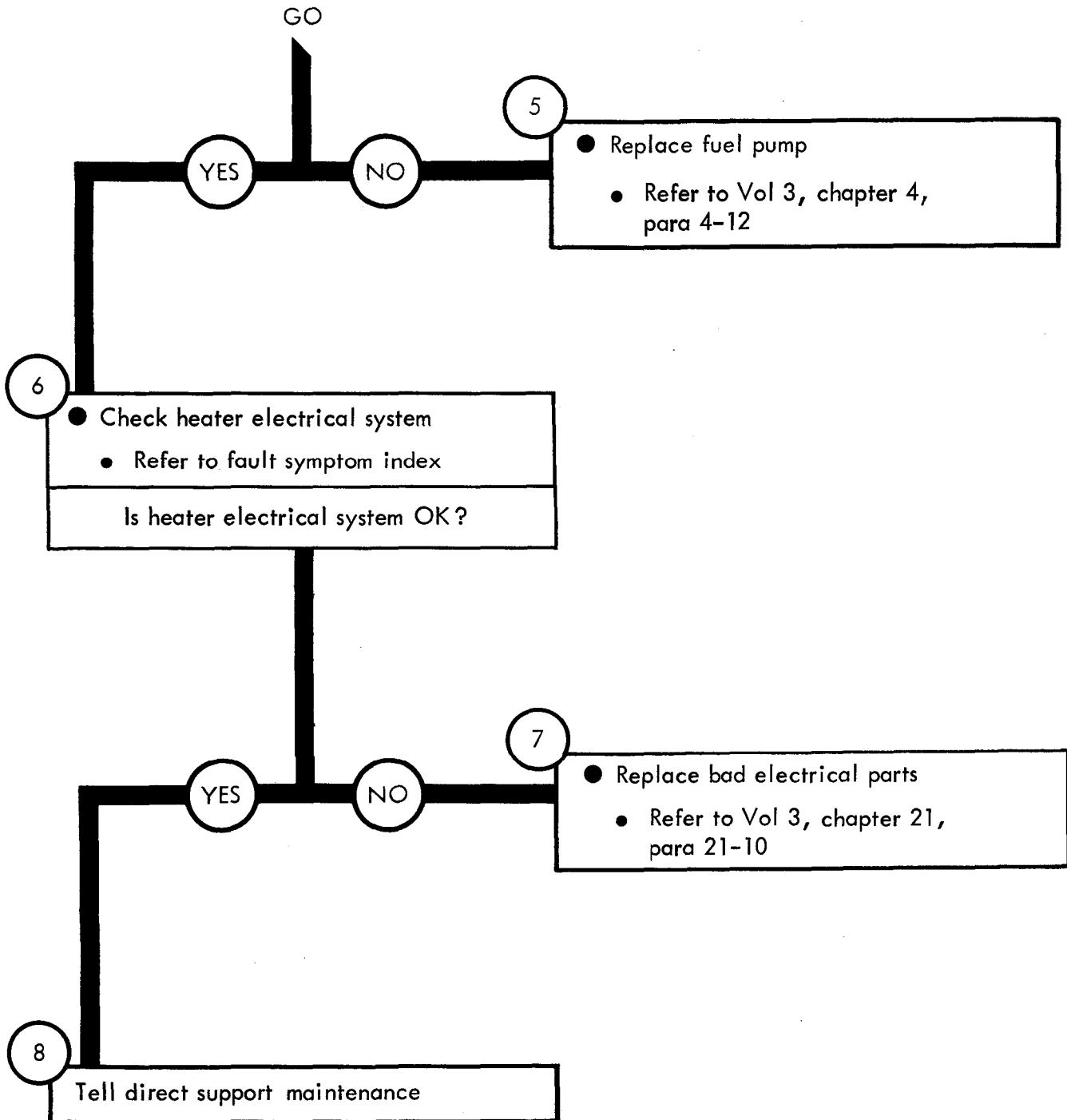

Figure 81-1 (Sheet 2 of 2)

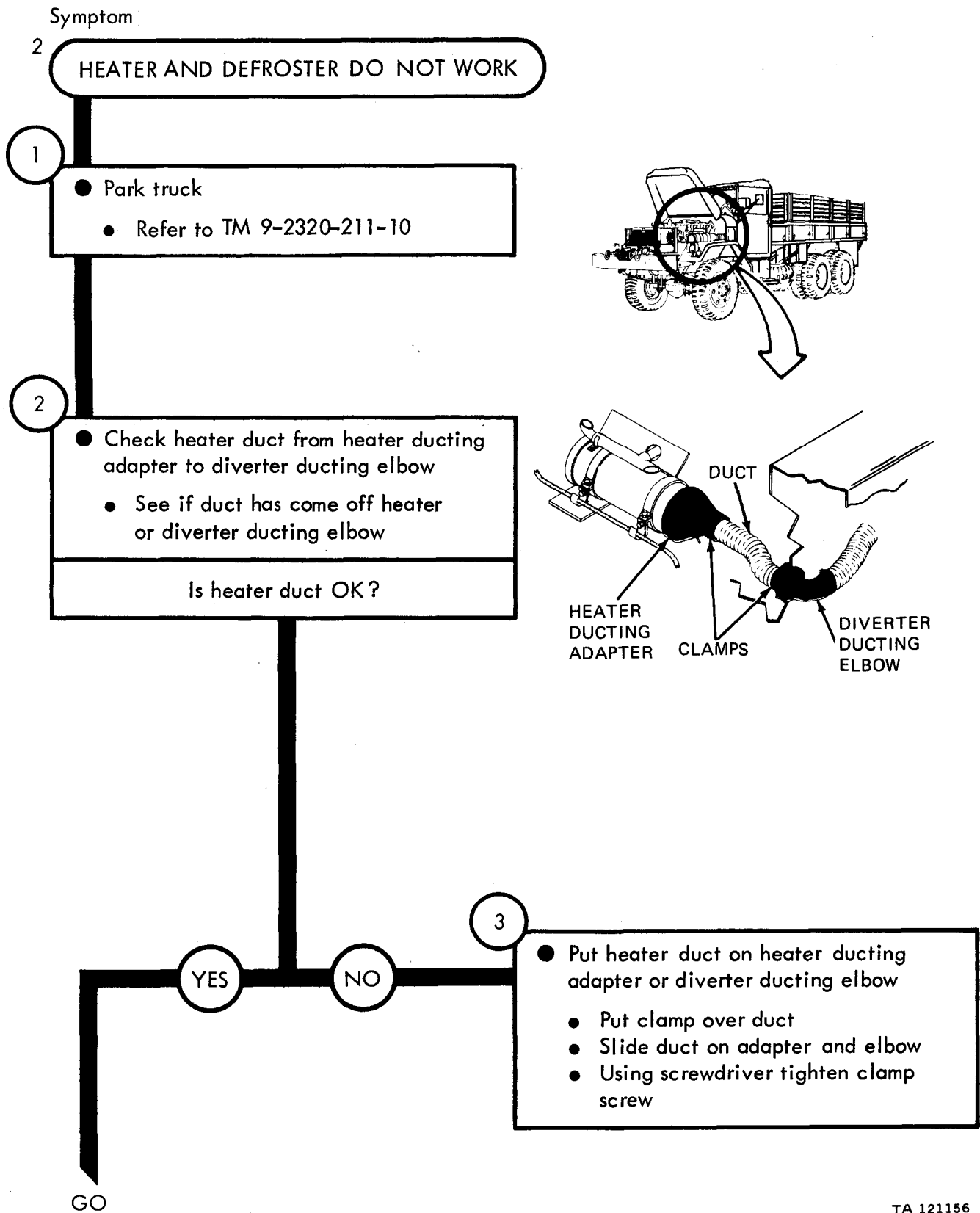

Figure 81-2 (Sheet 1 of 5)

TA 121156

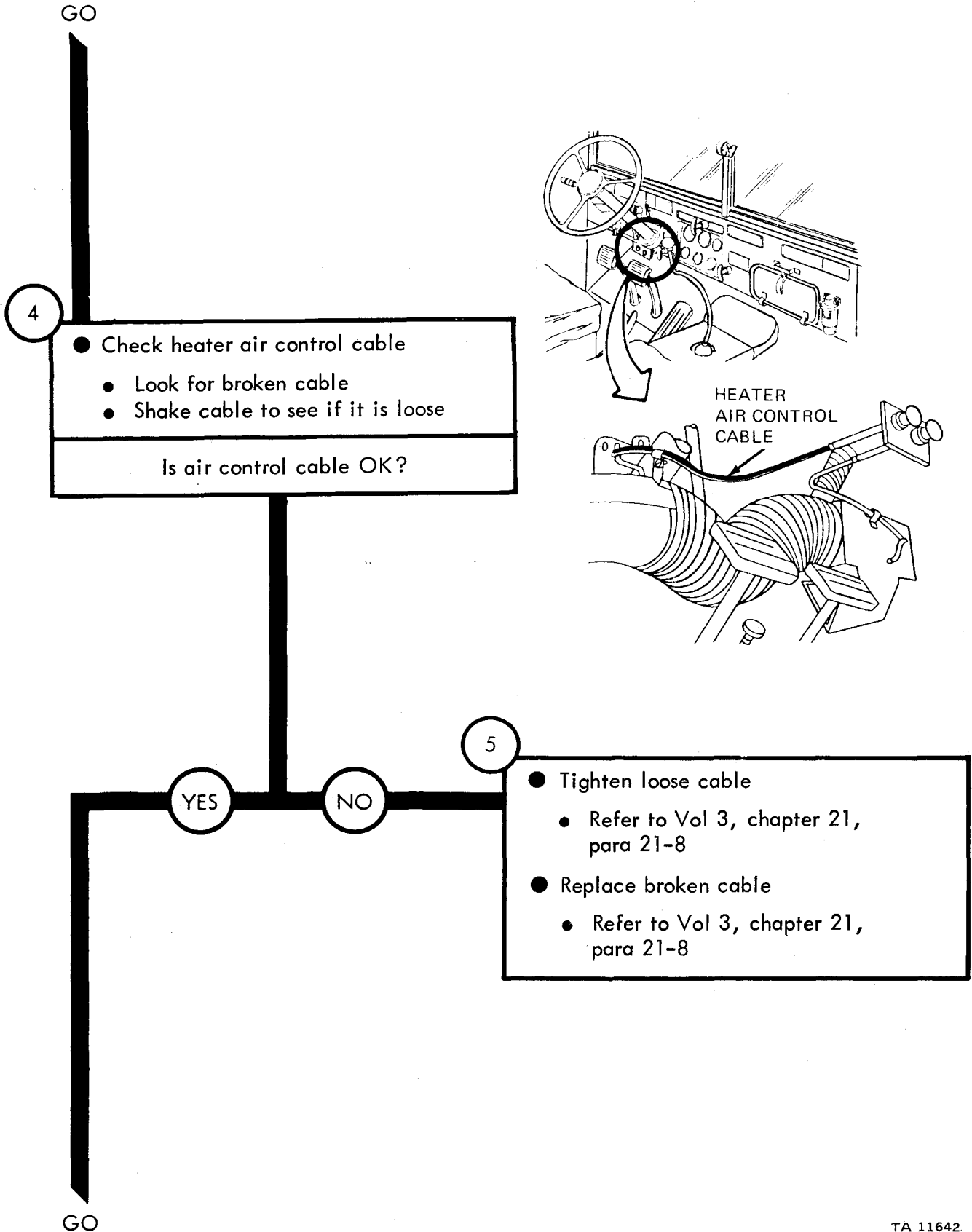

Figure 81-2 (Sheet 2 of 5)

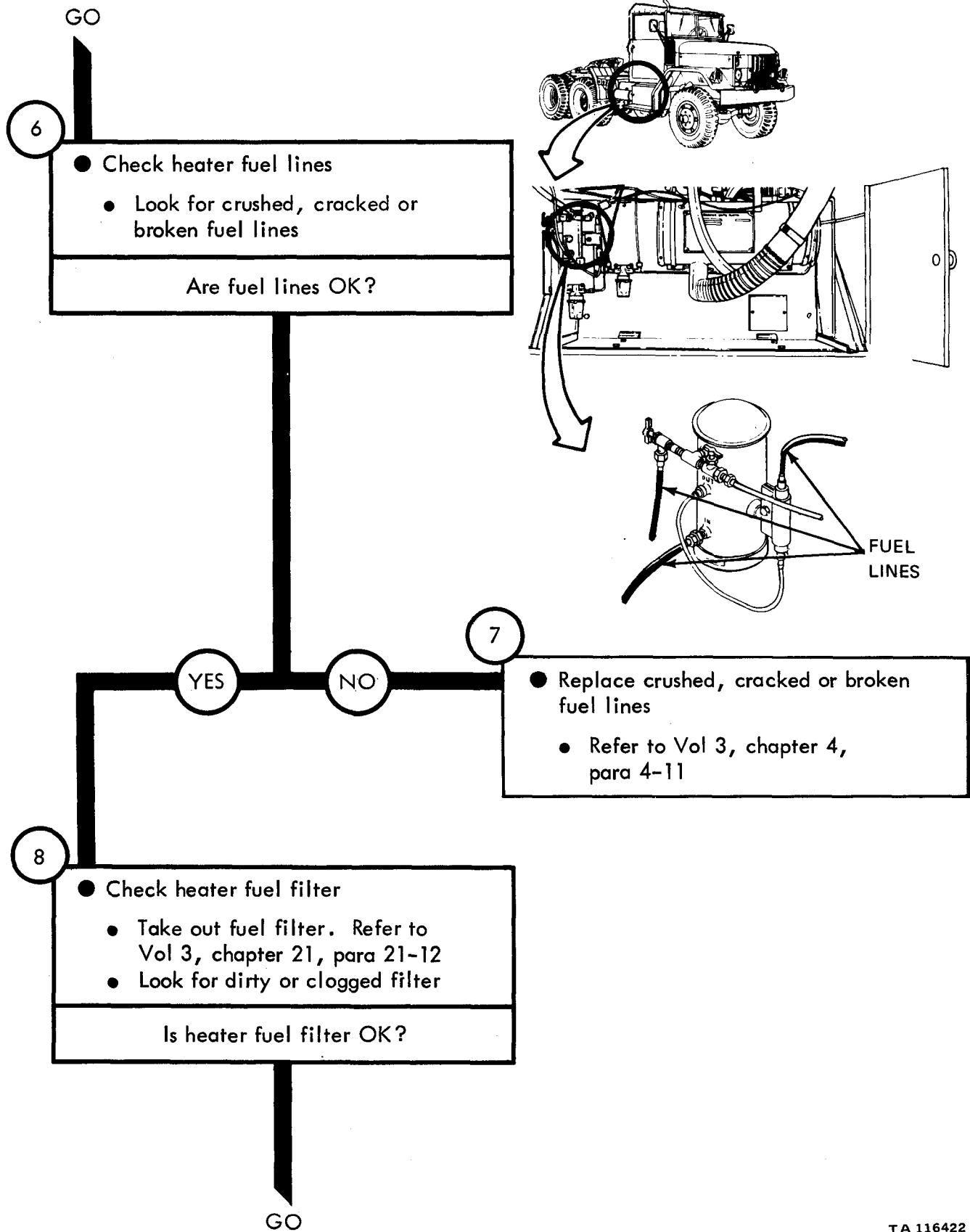

Figure 81-2 (Sheet 3 of 5)

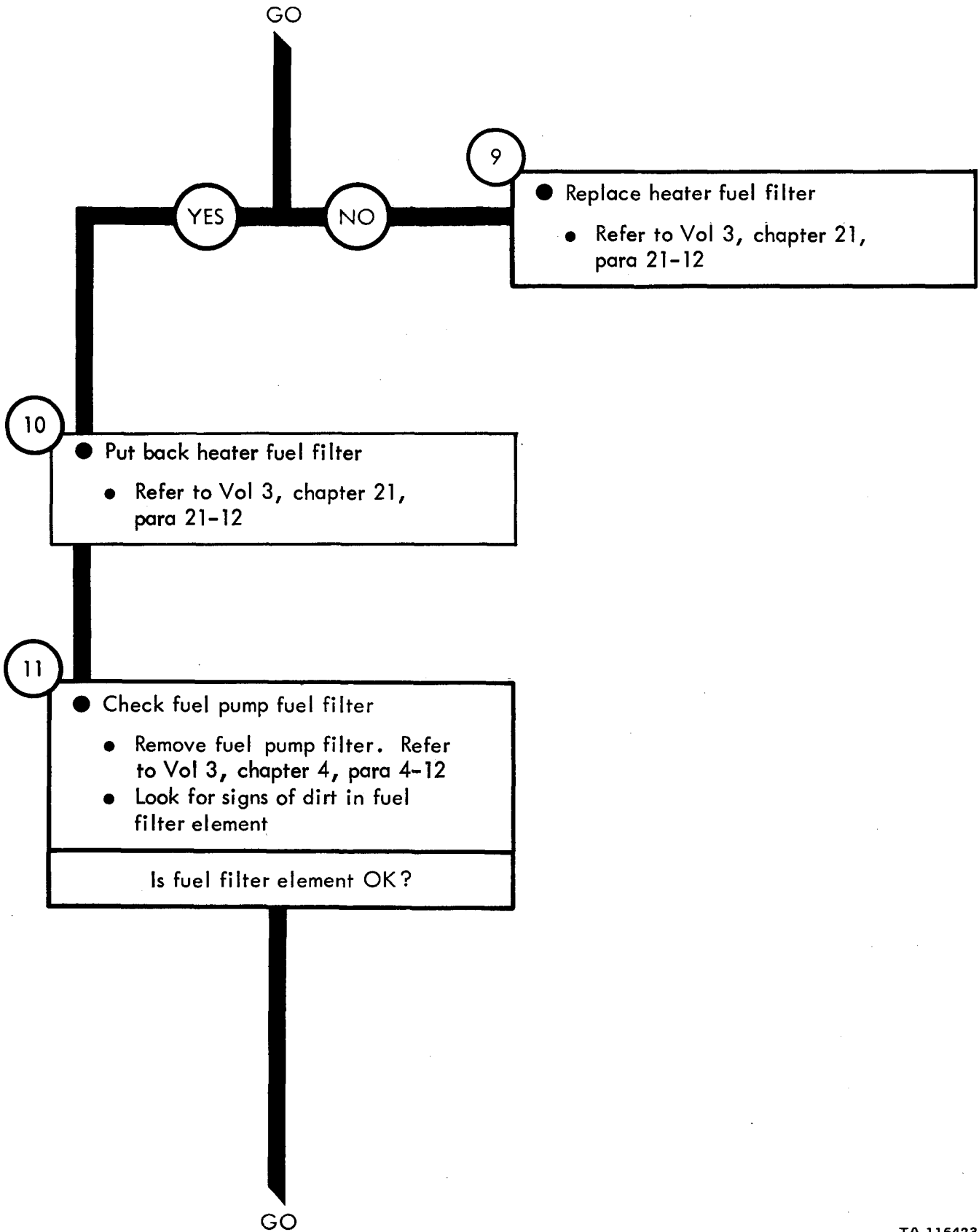

Figure 81-2 (Sheet 4 of 5)

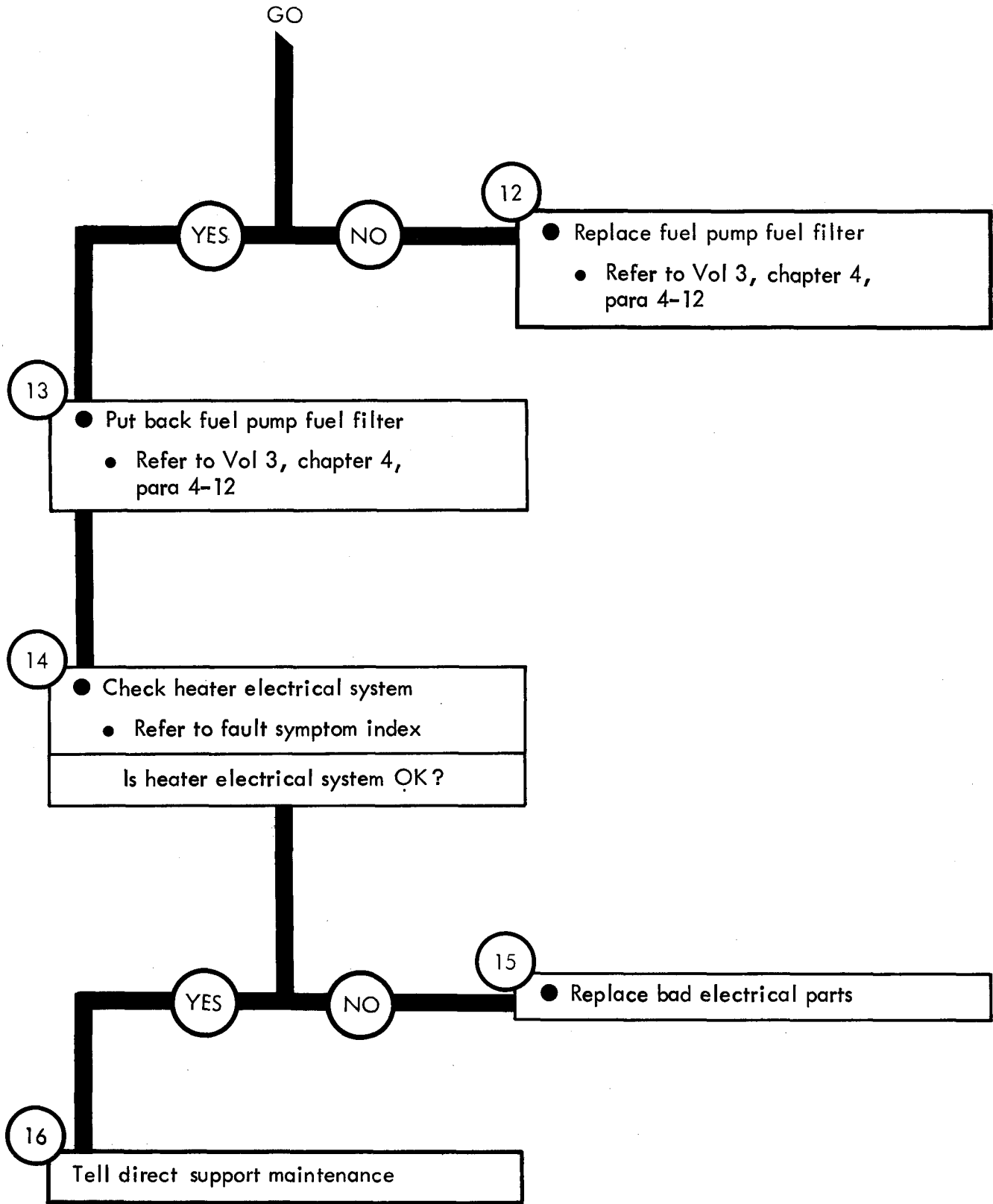
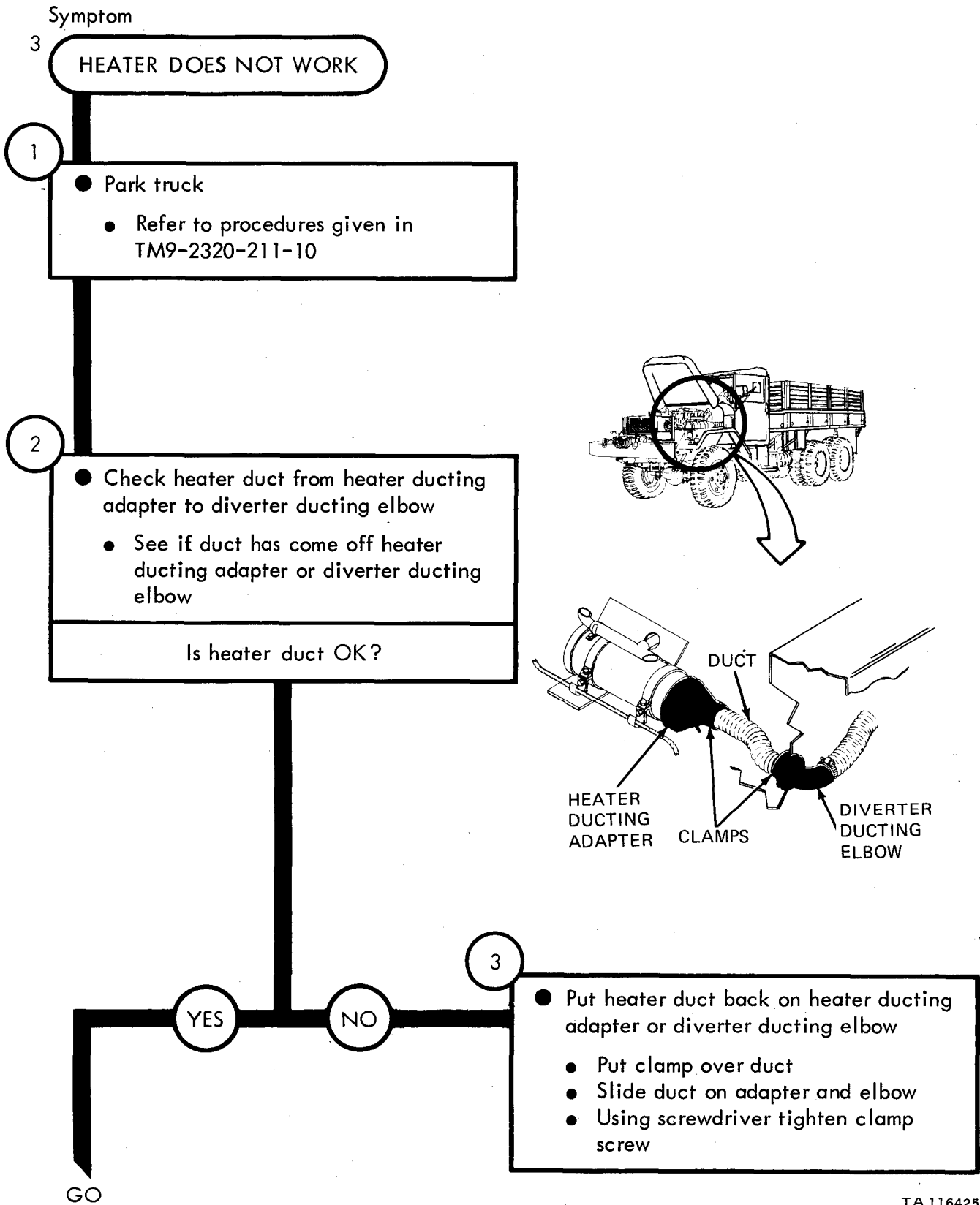

Figure 81-2 (Sheet 5 of 5)



TA 116425

Figure 81-3 (Sheet 1 of 2)

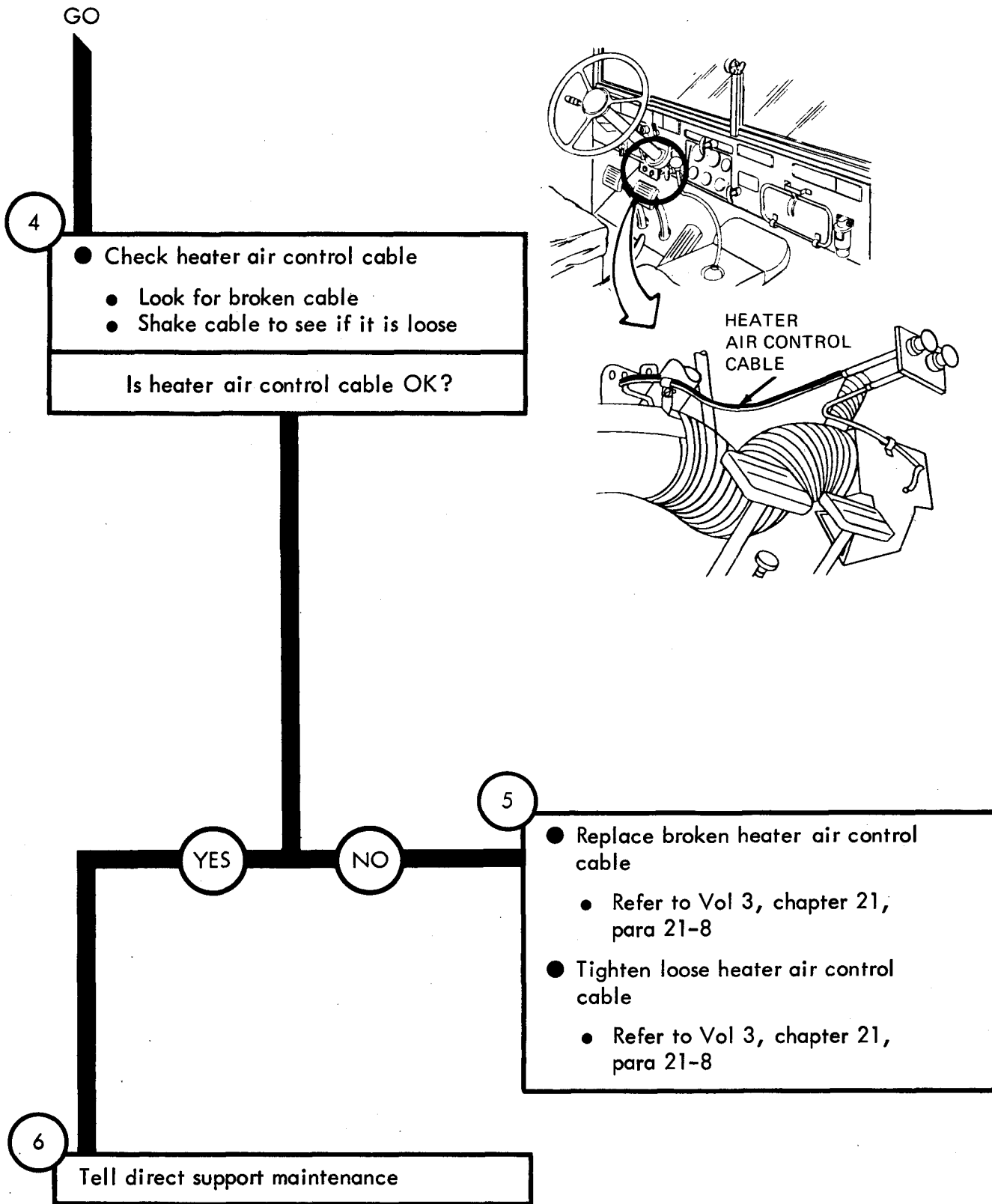

Figure 81-3 (Sheet 2 of 2)

Symptom

4 DEFROSTER DOES NOT WORK

1

- Park truck
- Refer to TM 9-2320-211-10

2

- Check defroster control cable
 - Look for broken cable
 - Shake cable to see if it is loose

Is defroster control cable OK?

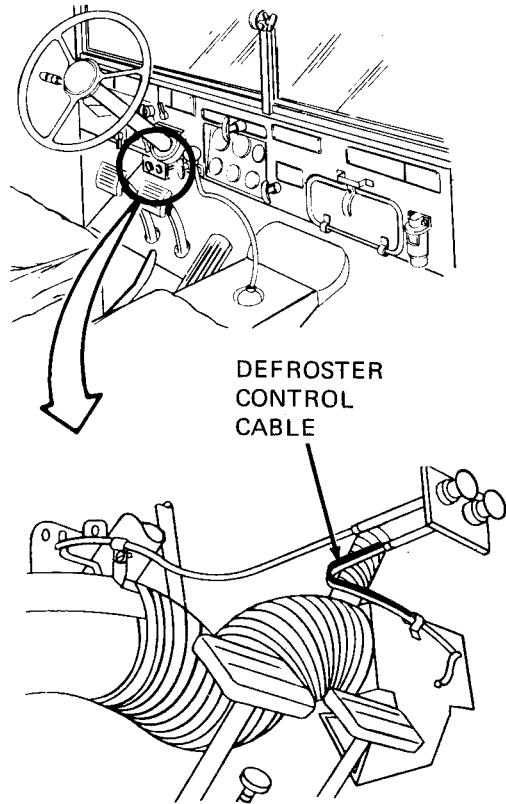

YES

NO

3

- Replace broken defroster control cable
 - Refer to Vol 3, chapter 21, para 21-8
- Tighten loose defroster control cable
 - Refer to Vol 3, chapter 21, para 21-8

GO

Figure 81-4 (Sheet 1 of 2)

TA 116427

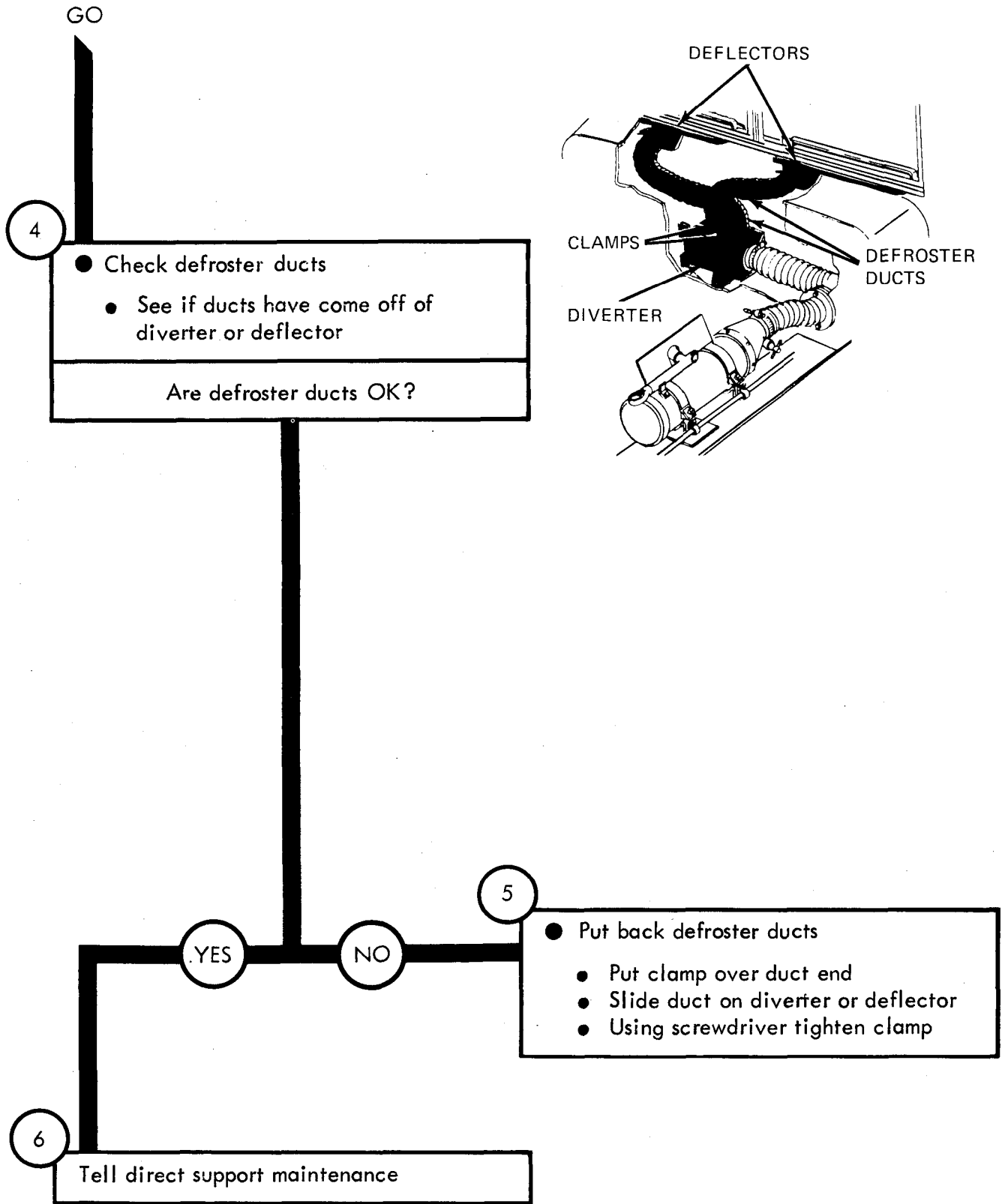

Figure 81-4 (Sheet 2 of 2)

Symptom

5

HEATER AND DEFROSTER DO NOT GIVE OFF ENOUGH HEAT

1

- Park truck
- Refer to TM 9-2320-211-10

2

- Check duct from heater ducting adapter to diverter ducting elbow
- See if duct has come off heater ducting adapter or diverter ducting elbow

Is heater duct OK?

GO

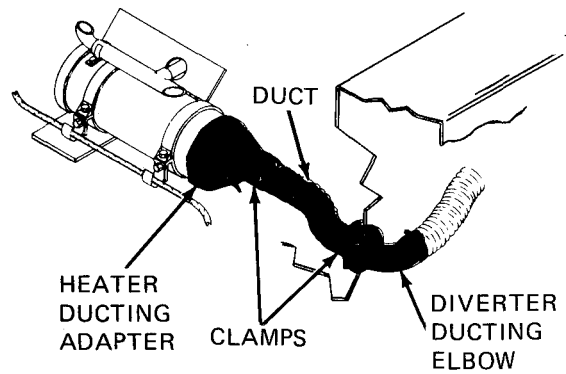
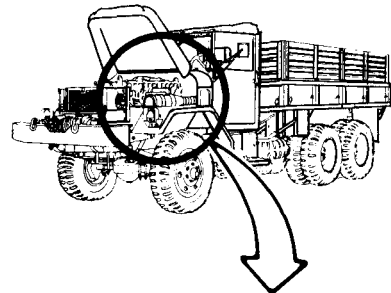

TA 116429

Figure 81-5 (Sheet 1 of 5)

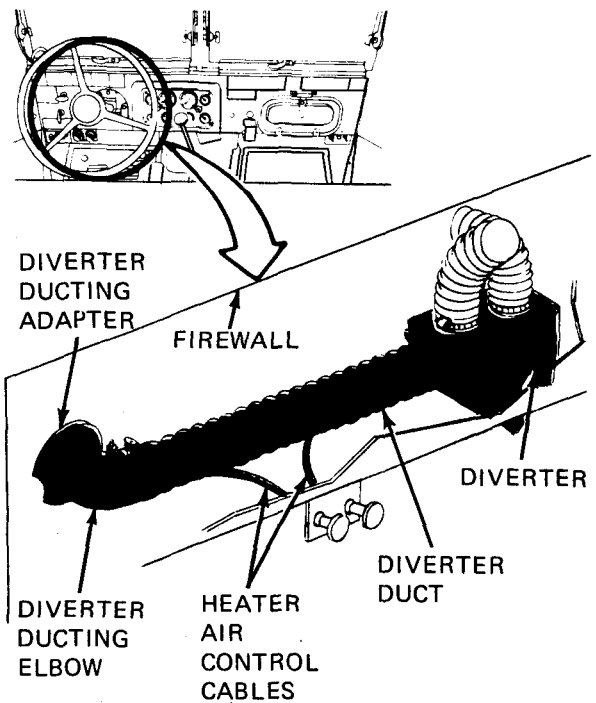
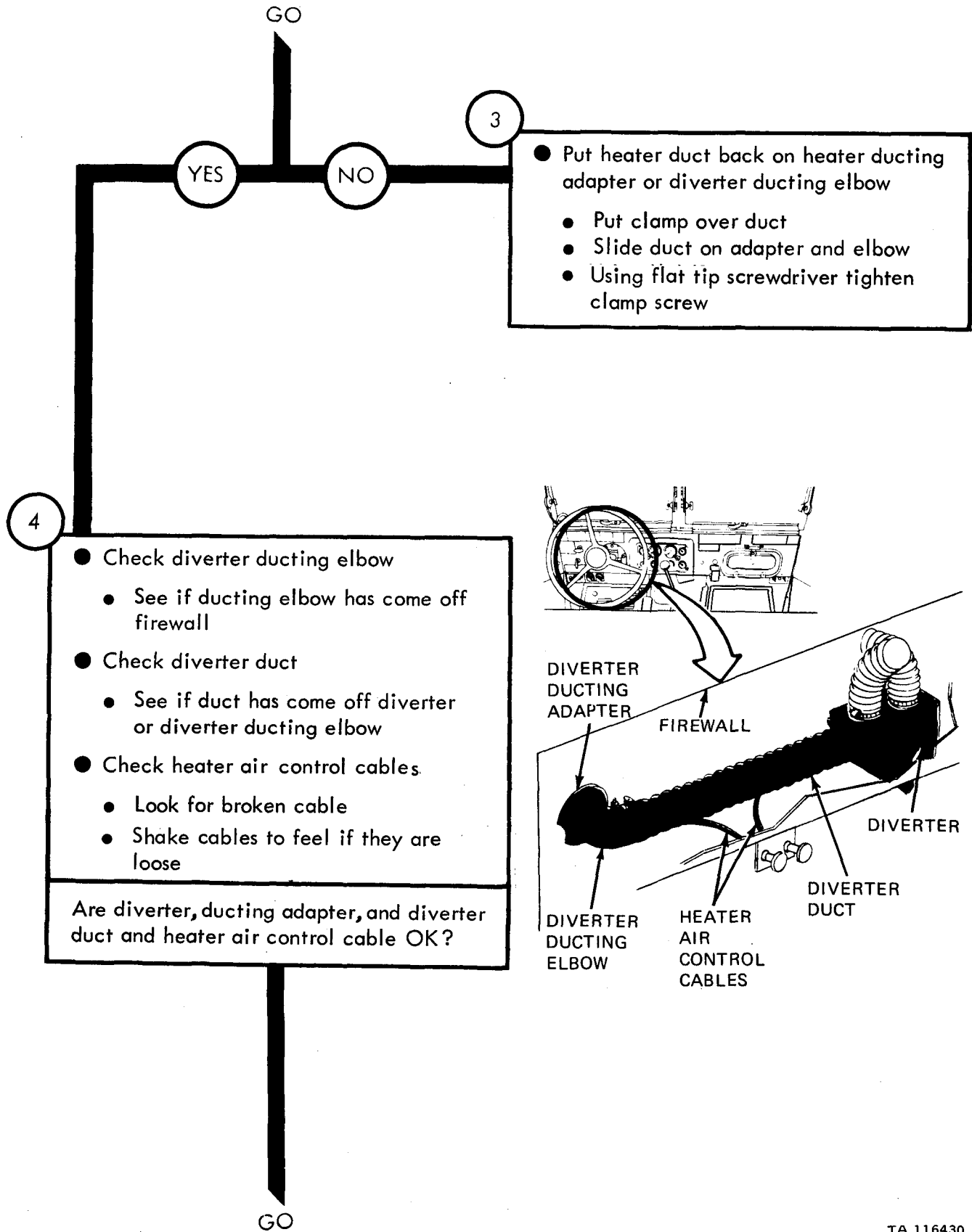

Figure 81-5 (Sheet 2 of 5)

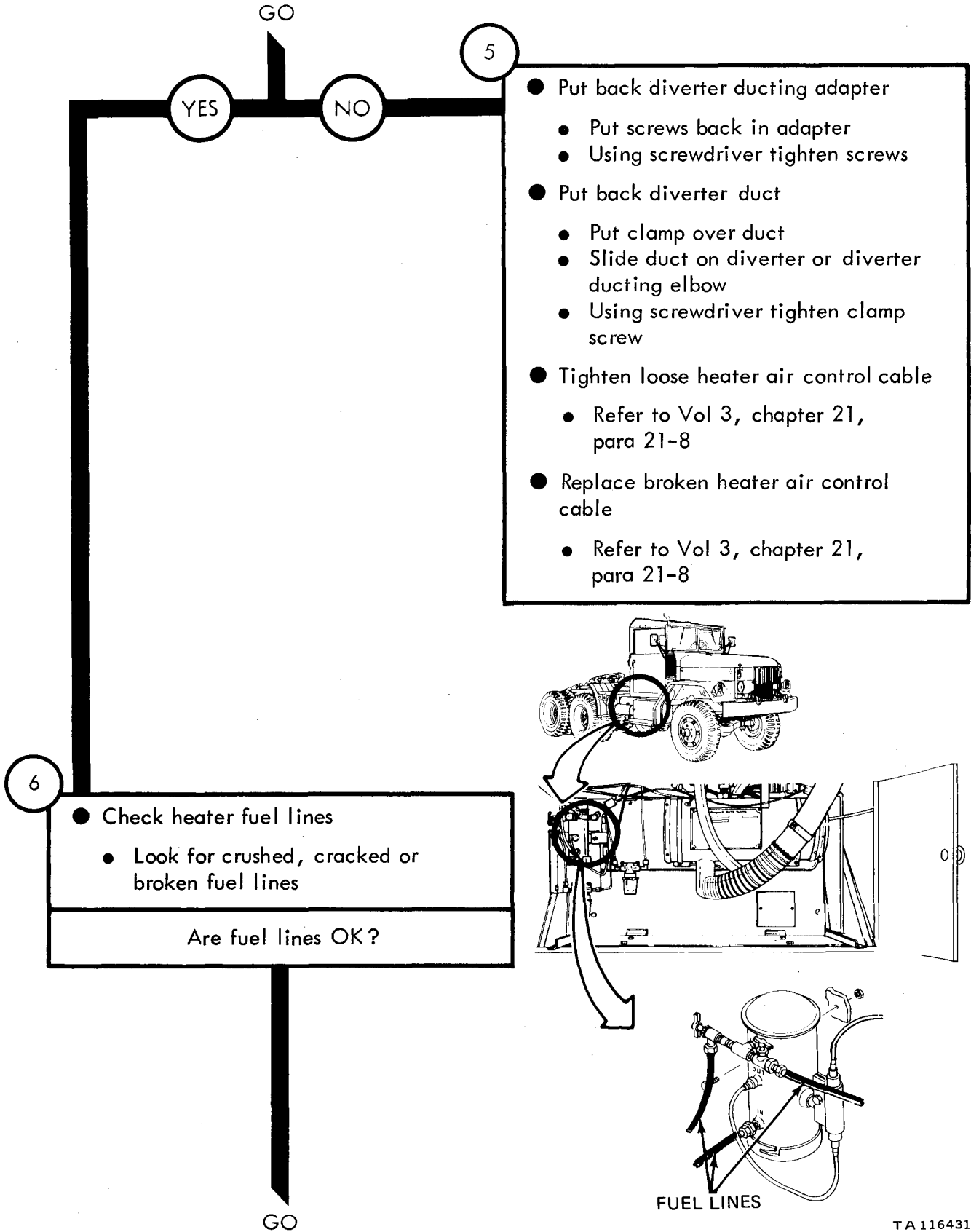

Figure 81-5 (Sheet 3 of 5)

TA 116431

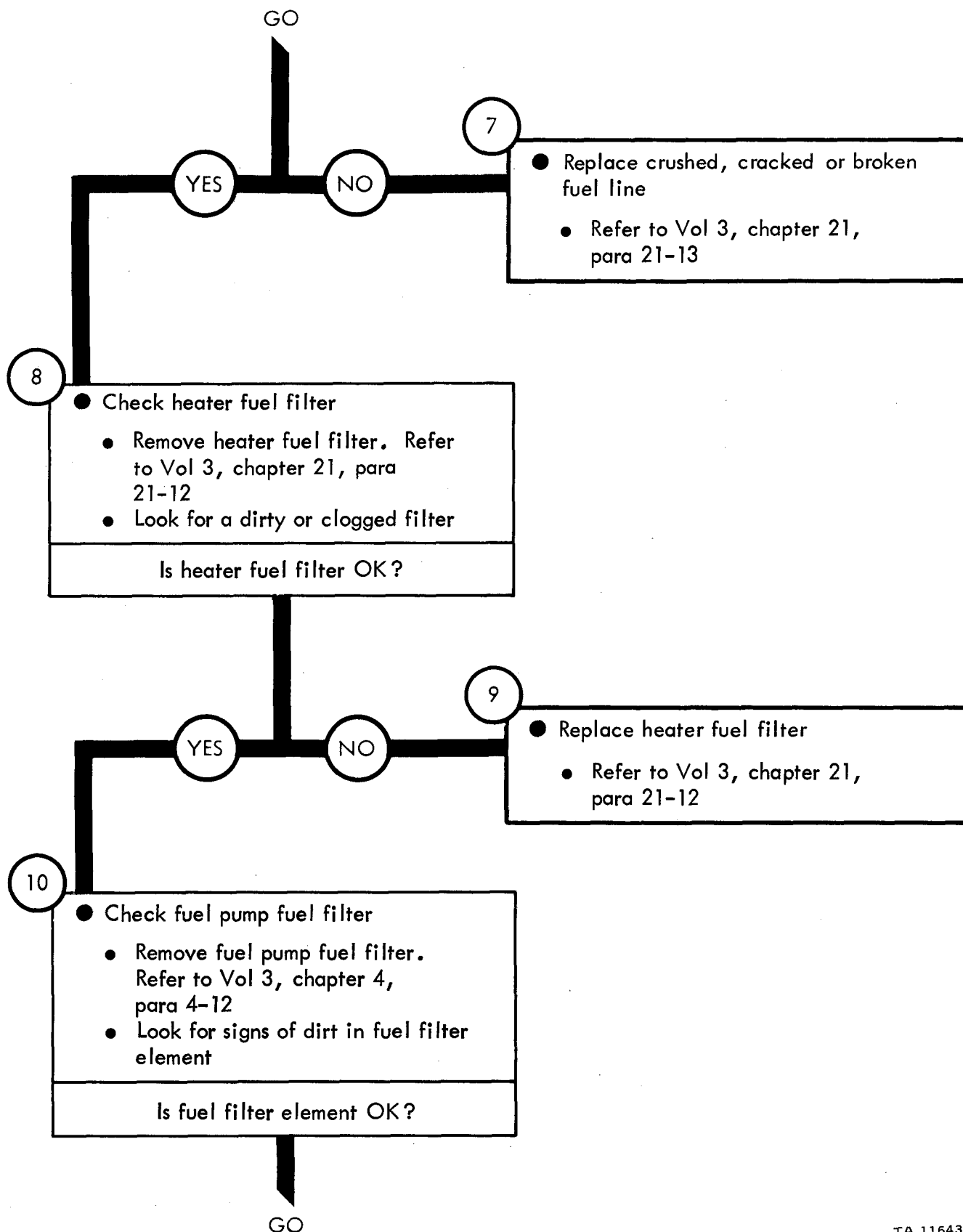

Figure 81-5 (Sheet 4 of 5)

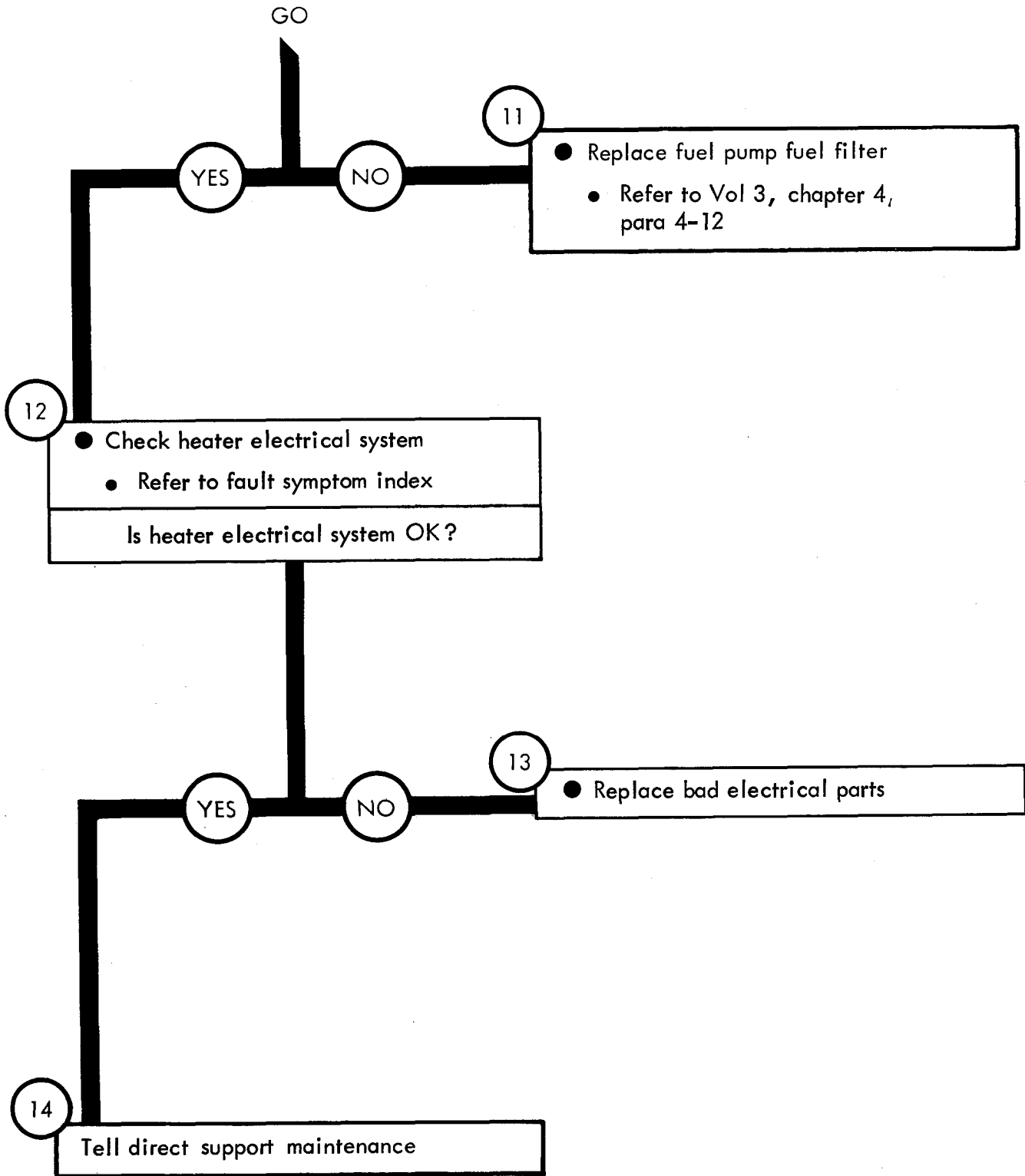

Figure 81-5 (Sheet 5 of 5)

Symptom

6 DEFROSTER DOES NOT GIVE OFF ENOUGH HEAT

1

- Park truck
- Refer to TM 9-2320-211-10

2

- Check defroster control cable
 - Look for broken cable
 - Shake cable to see if it is loose

Is defroster control cable OK?

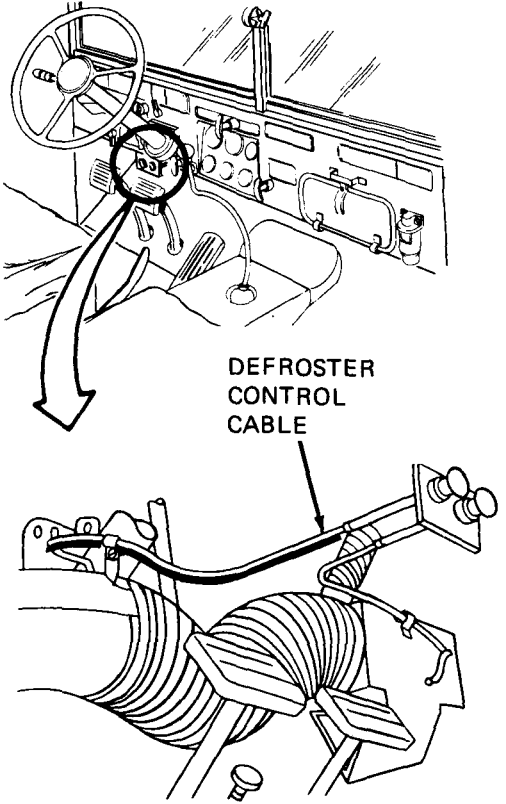

YES

NO

3

- Replace broken defroster control cable
 - Refer to Vol 3, chapter 21, para 21-8
- Tighten loose defroster control cable
 - Refer to Vol 3, chapter 21, para 21-8

GO

TA 116434

Figure 81-6 (Sheet 1 of 2)

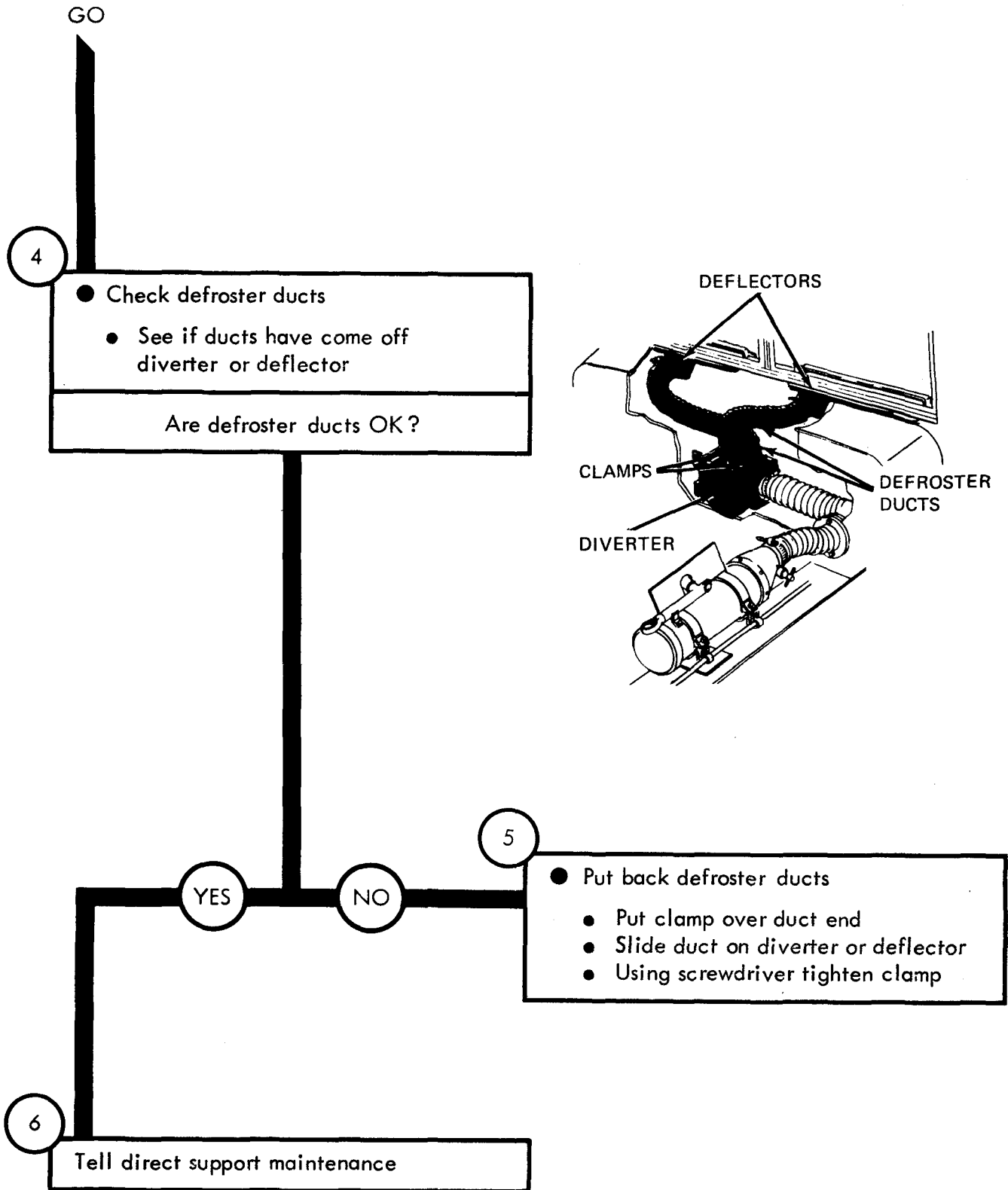

Figure 81-6 (Sheet 2 of 2)

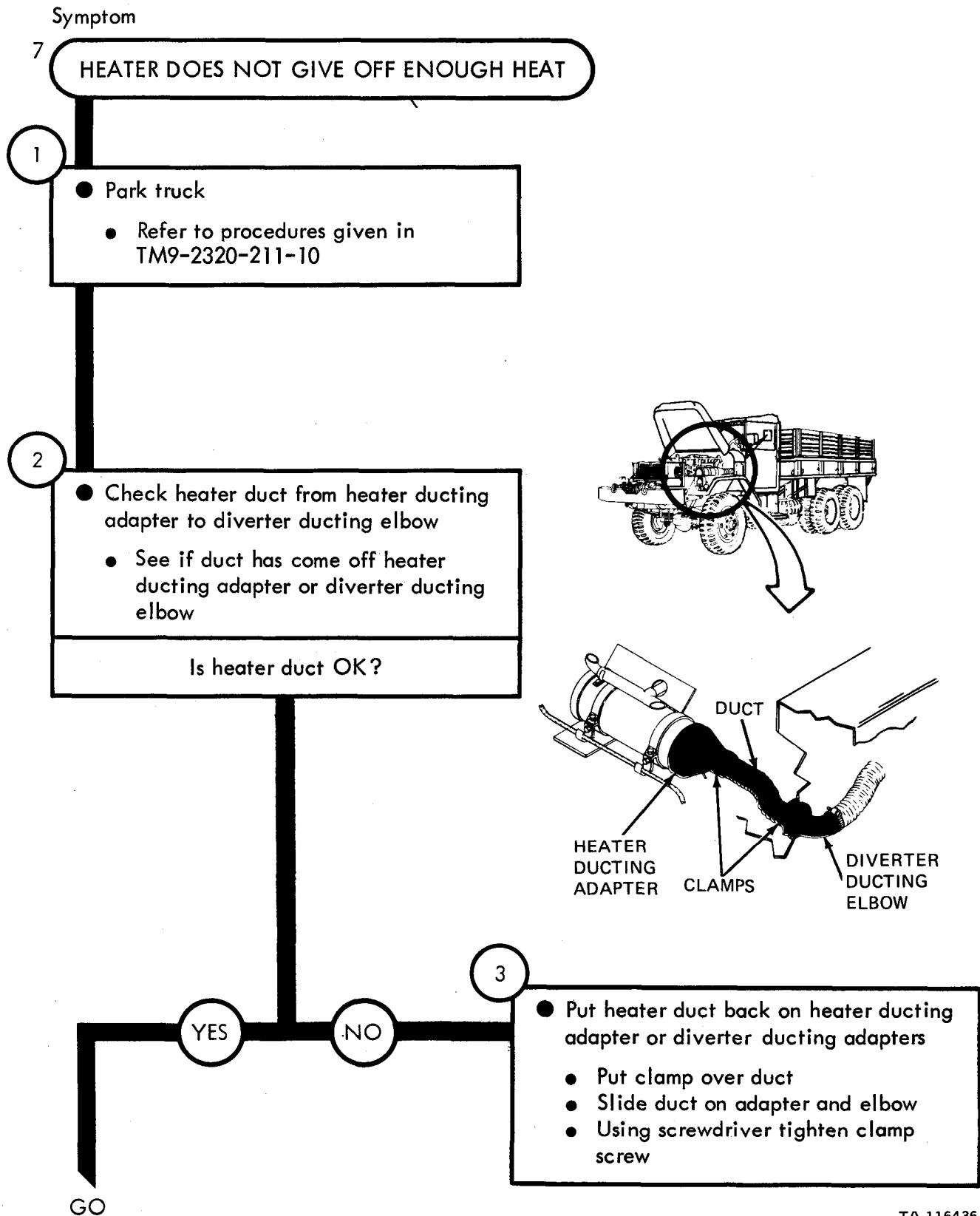

Figure 81-7 (Sheet 1 of 2)

TA 116436

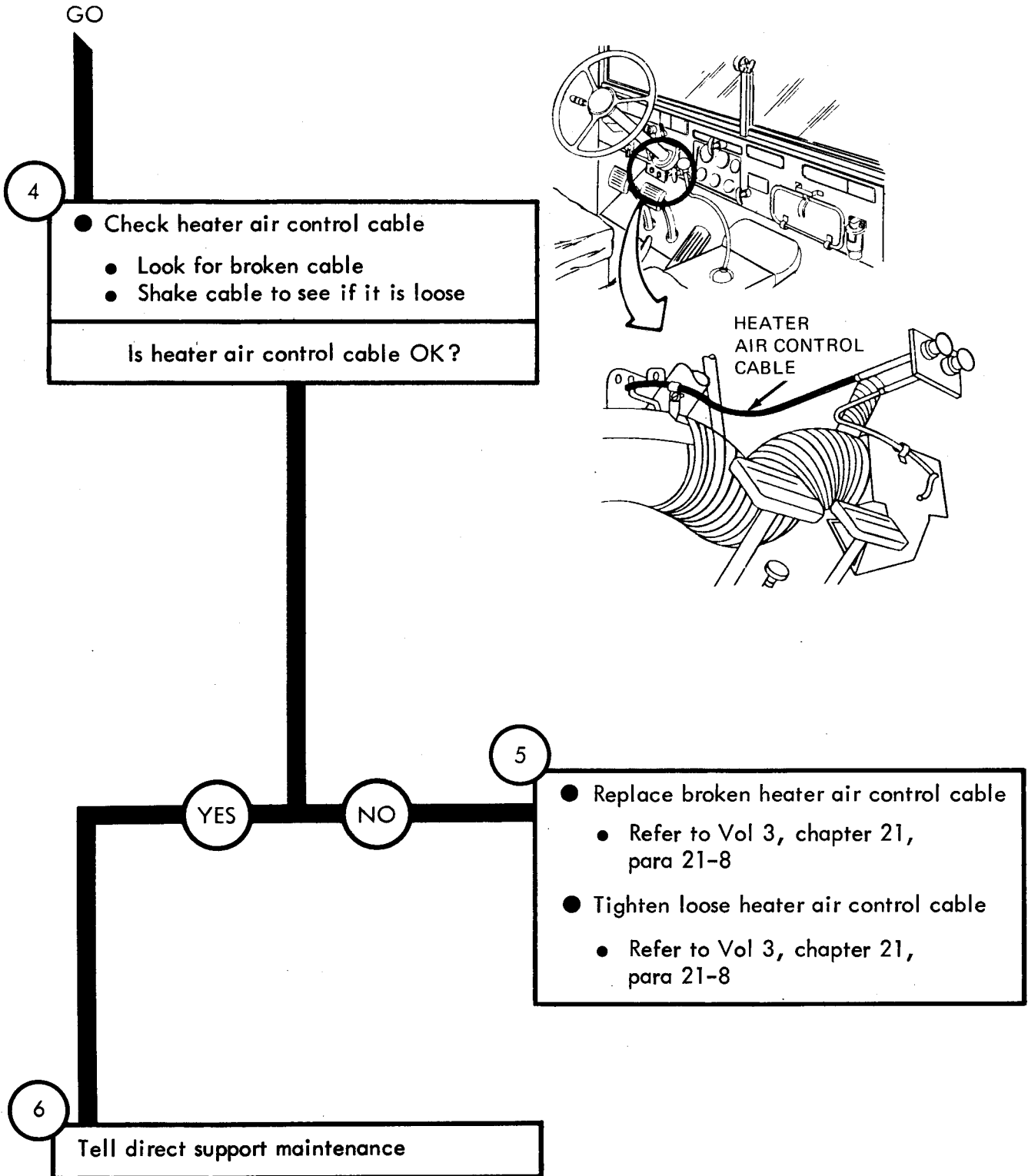

Figure 81-1 (Sheet 2 of 2)

CHAPTER 82

FUEL BURNING HEATER SYSTEM TROUBLESHOOTING SUMMARY

82-1. GENERAL. This chapter gives a summary of troubleshooting procedures given in chapter 81, for the Fuel Burning Heater System.

82-2. PROCEDURES. The summary in this chapter covers all fault symptoms found in the detailed troubleshooting procedures. Chapter 7 outlines a sample troubleshooting procedure. The summary procedures are based on the "what-to-do" portions of the detailed procedures and do not include the "How-to-do-it" instructions. Warnings, cautions, and notes are given where needed.

FUEL BURNING HEATER SYSTEM TROUBLESHOOTING SUMMARY

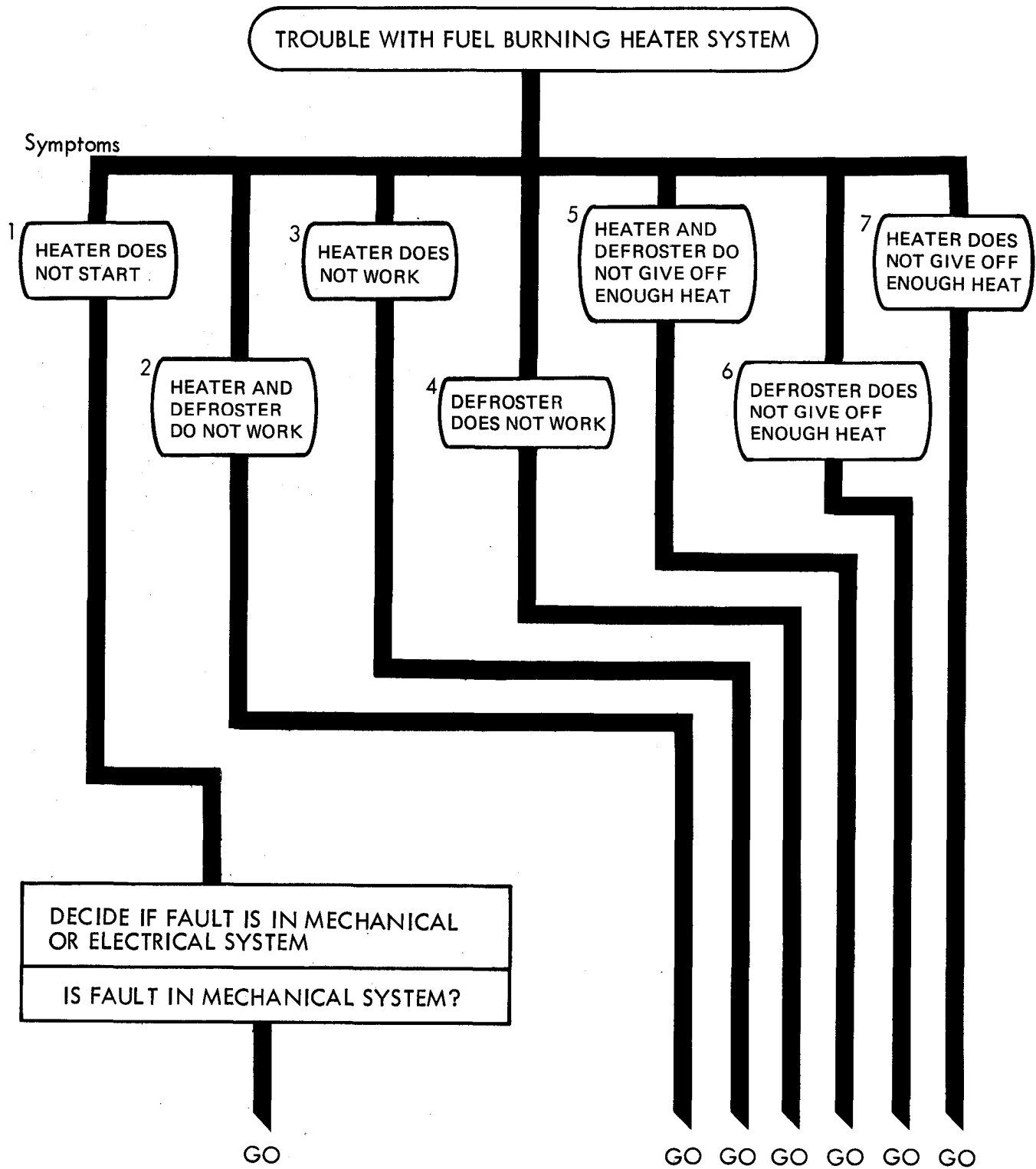
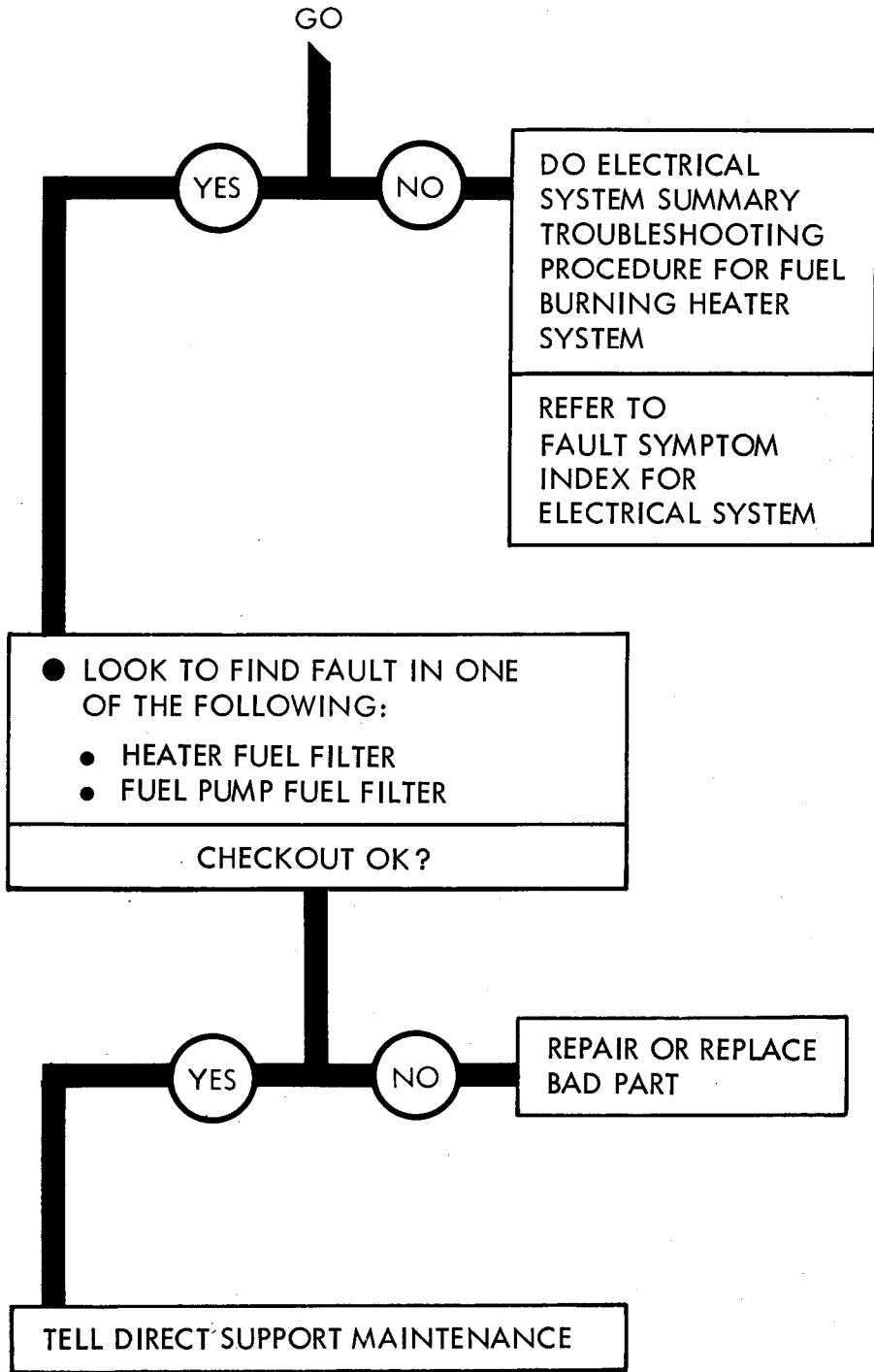

Figure 82-1 (Sheet 1 of 8)



NOTE: FOR DETAILED TROUBLESHOOTING PROCEDURES, SEE SYMPTOM INDEX

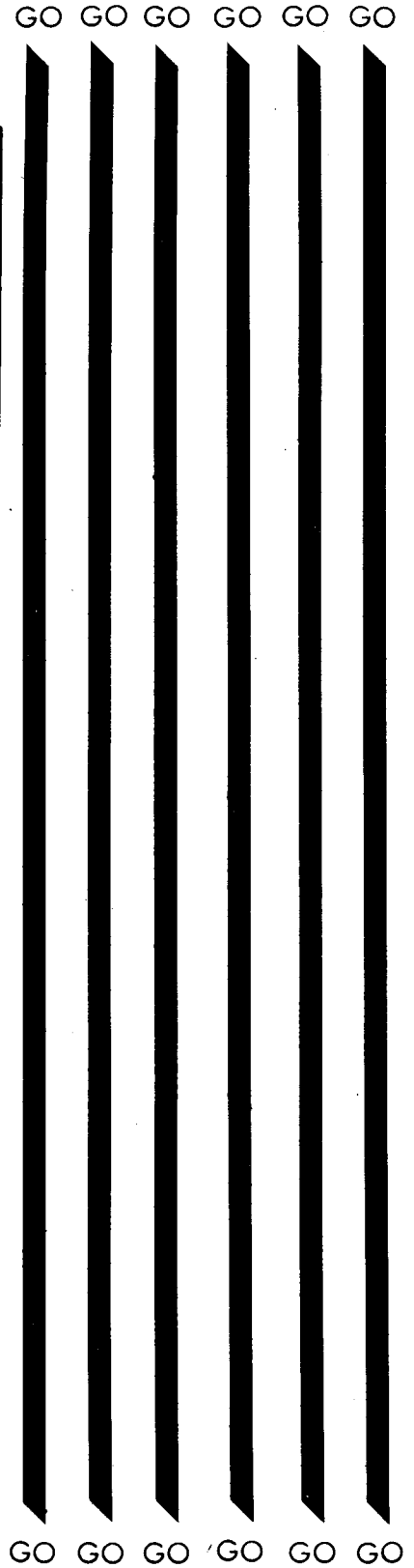
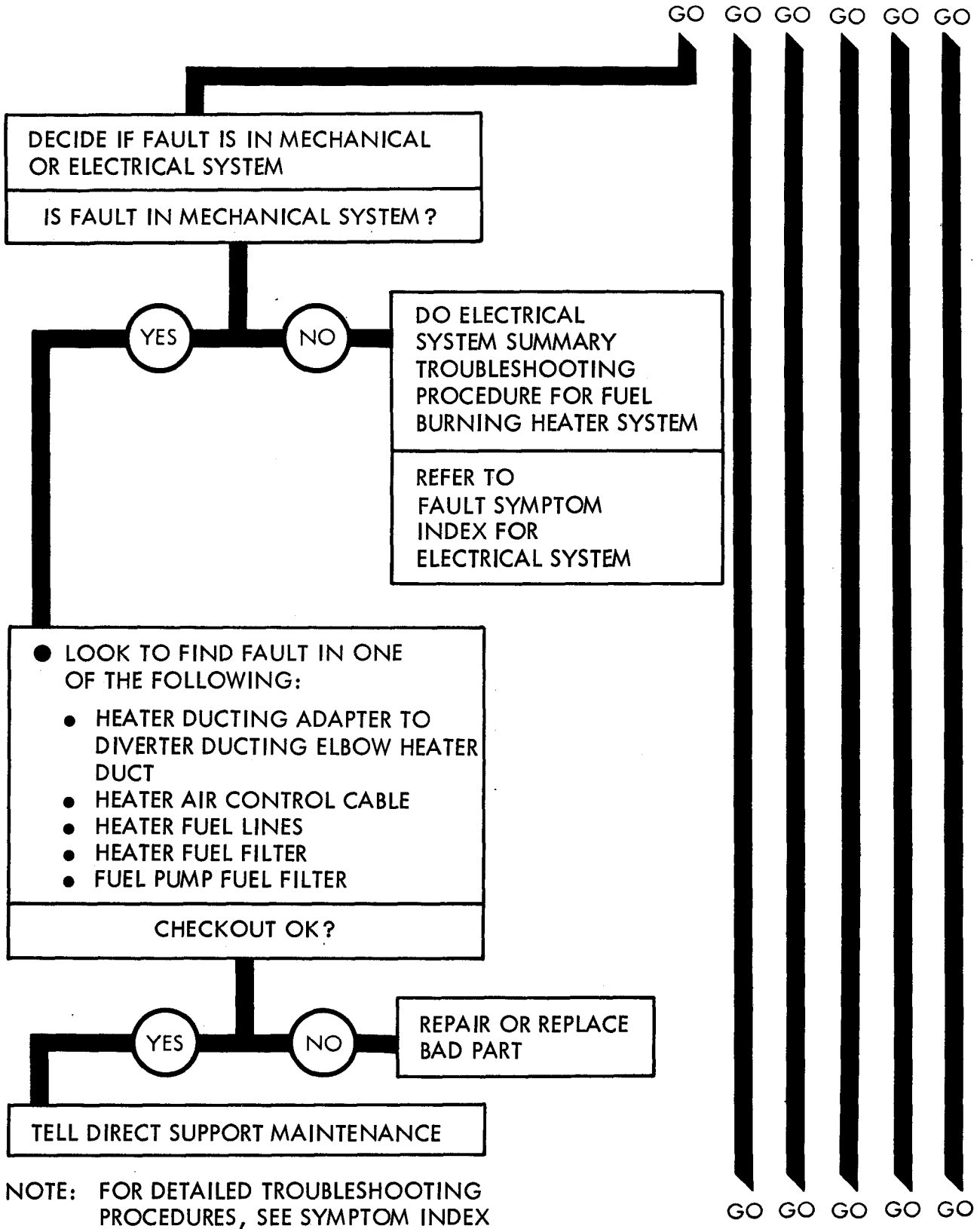

Figure 82-1 (Sheet 2 of 8)



NOTE: FOR DETAILED TROUBLESHOOTING PROCEDURES, SEE SYMPTOM INDEX

Figure 82-1 (Sheet 3 of 8)

TA 116440

GO GO GO GO GO

● LOOK TO FIND FAULT IN ONE OF THE FOLLOWING:

- HEATER DUCTING ADAPTER TO DIVERTER DUCTING ELBOW
- HEATER DUCT
- HEATER AIR CONTROL CABLE

CHECKOUT OK?

YES

NO

REPAIR OR REPLACE BAD PART

TELL DIRECT SUPPORT MAINTENANCE

NOTE: FOR DETAILED TROUBLESHOOTING PROCEDURES, SEE SYMPTOM INDEX

GO GO GO GO

TA 116441

Figure 82-1 (Sheet 4 of 8)

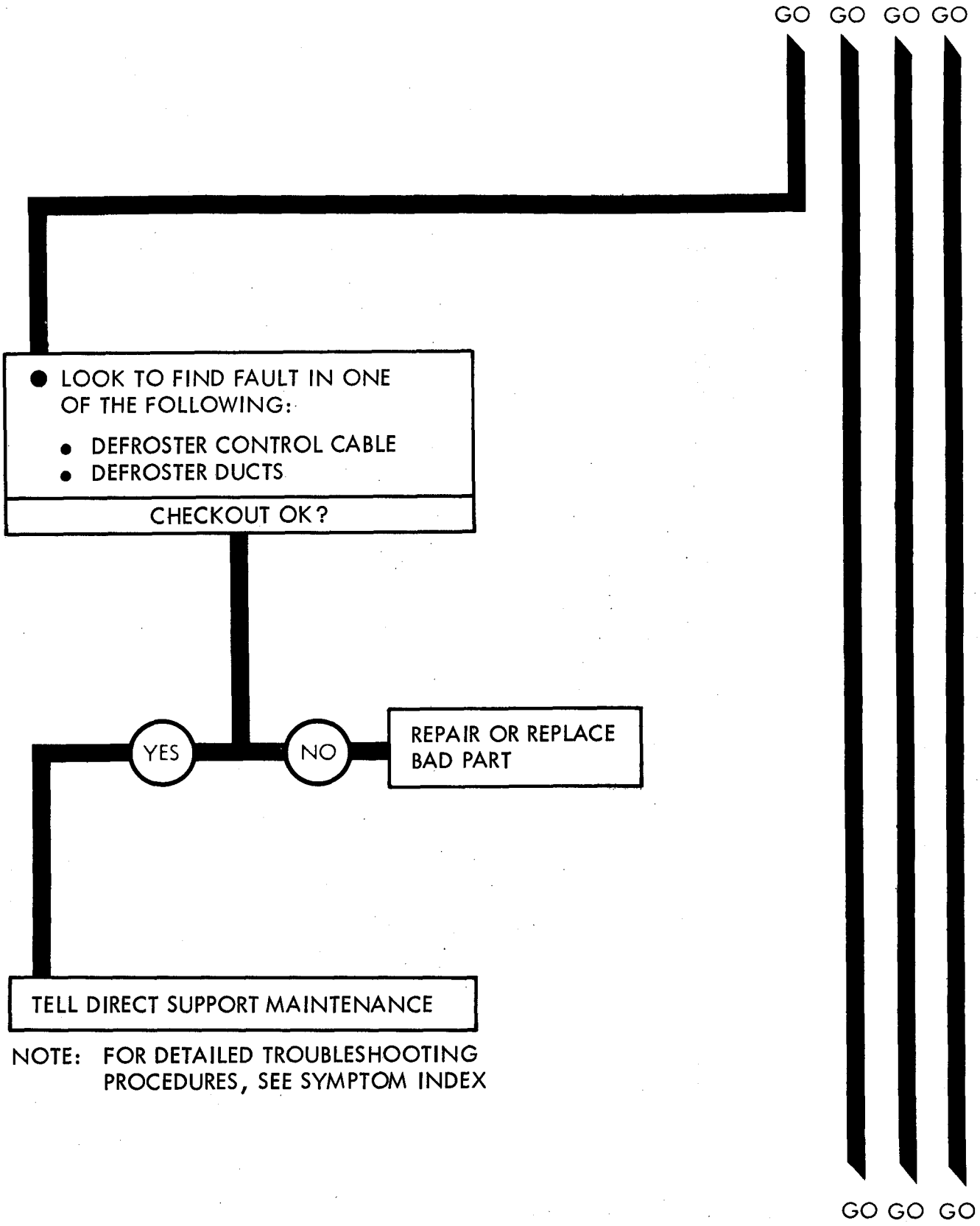

NOTE: FOR DETAILED TROUBLESHOOTING PROCEDURES, SEE SYMPTOM INDEX

Figure 82-1 (Sheet 5 of 8)

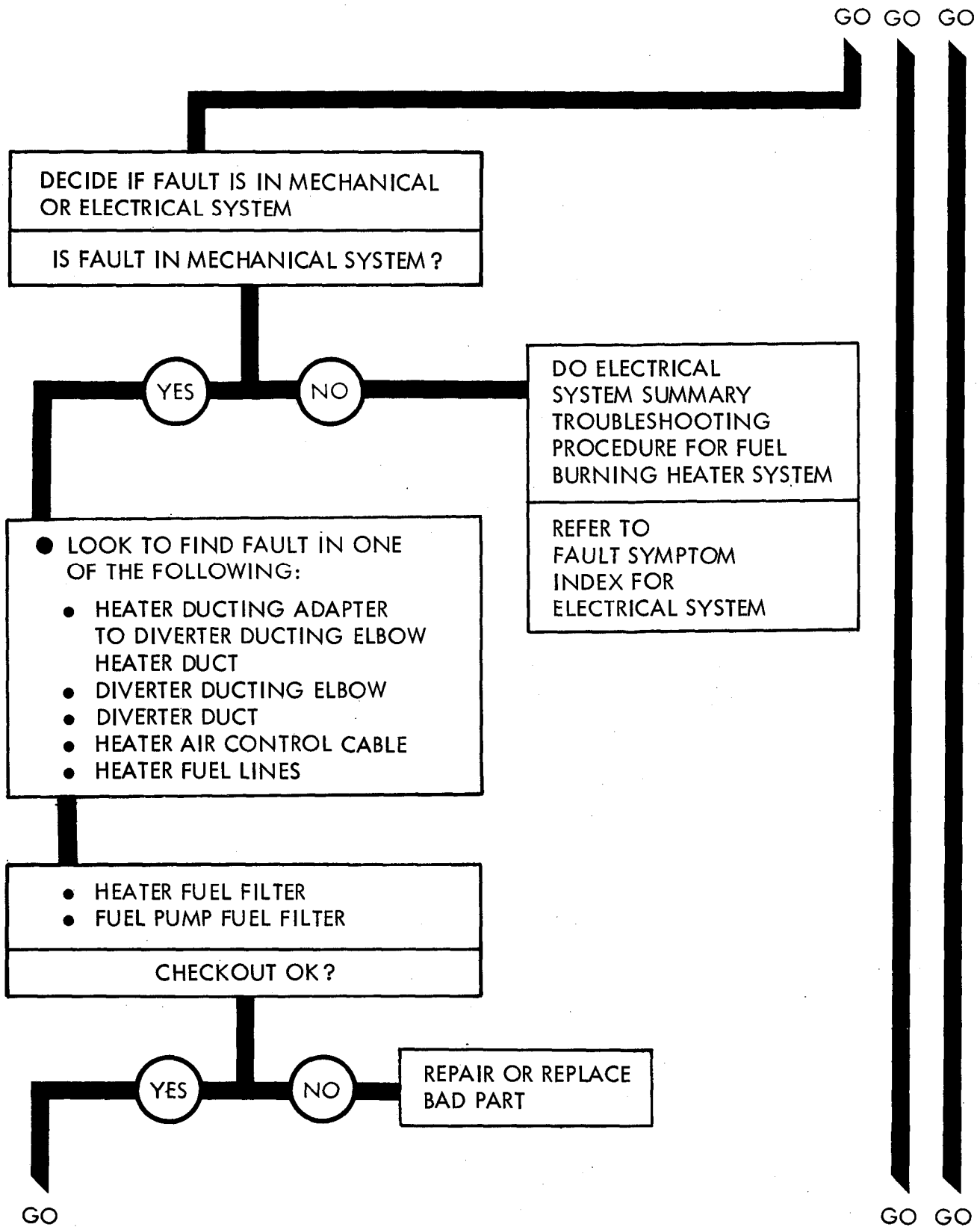
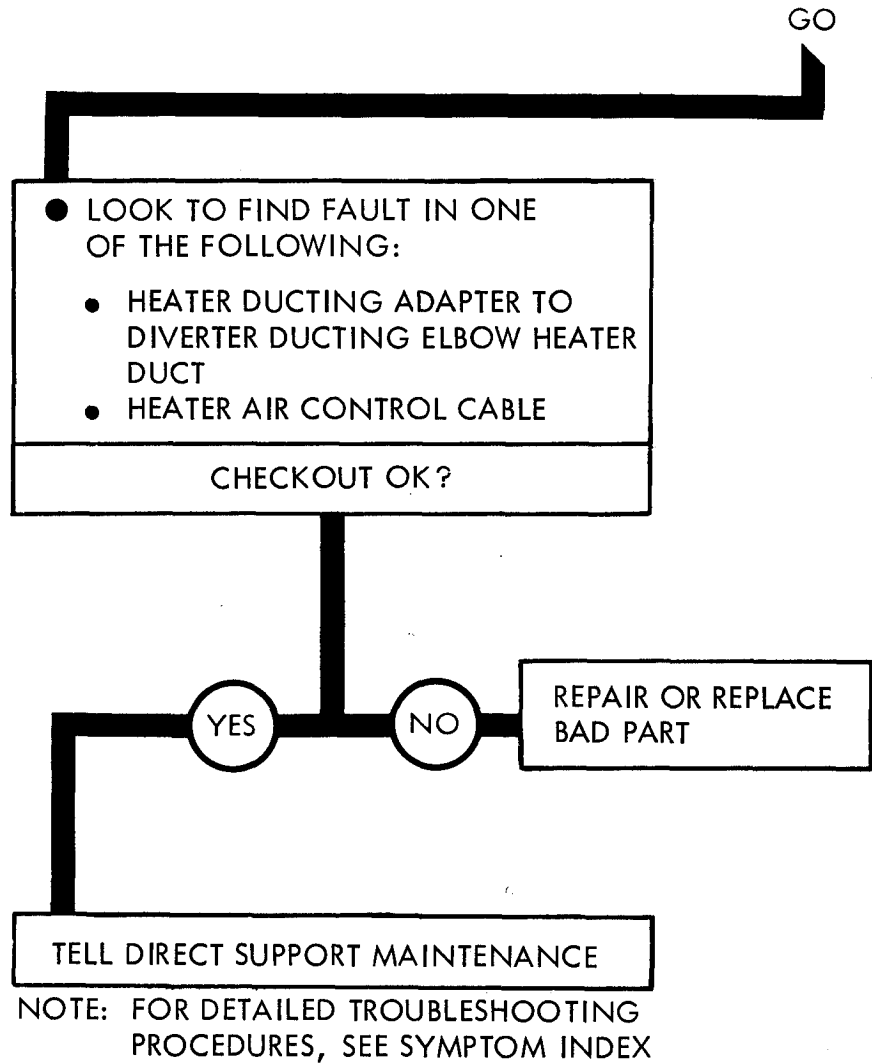

Figure 82-1 (Sheet 6 of 8)

TA 116443



CHAPTER 83

FUEL BURNING HEATER SYSTEM CHECKOUT PROCEDURES

83-1. GENERAL. This chapter gives procedures for checking out the system after troubleshooting and repair have been done. Procedures are set up in flow chart form showing the checkout steps in order and referring to the fault symptom index when the system does not checkout.

FUEL BURNING HEATER SYSTEM CHECKOUT

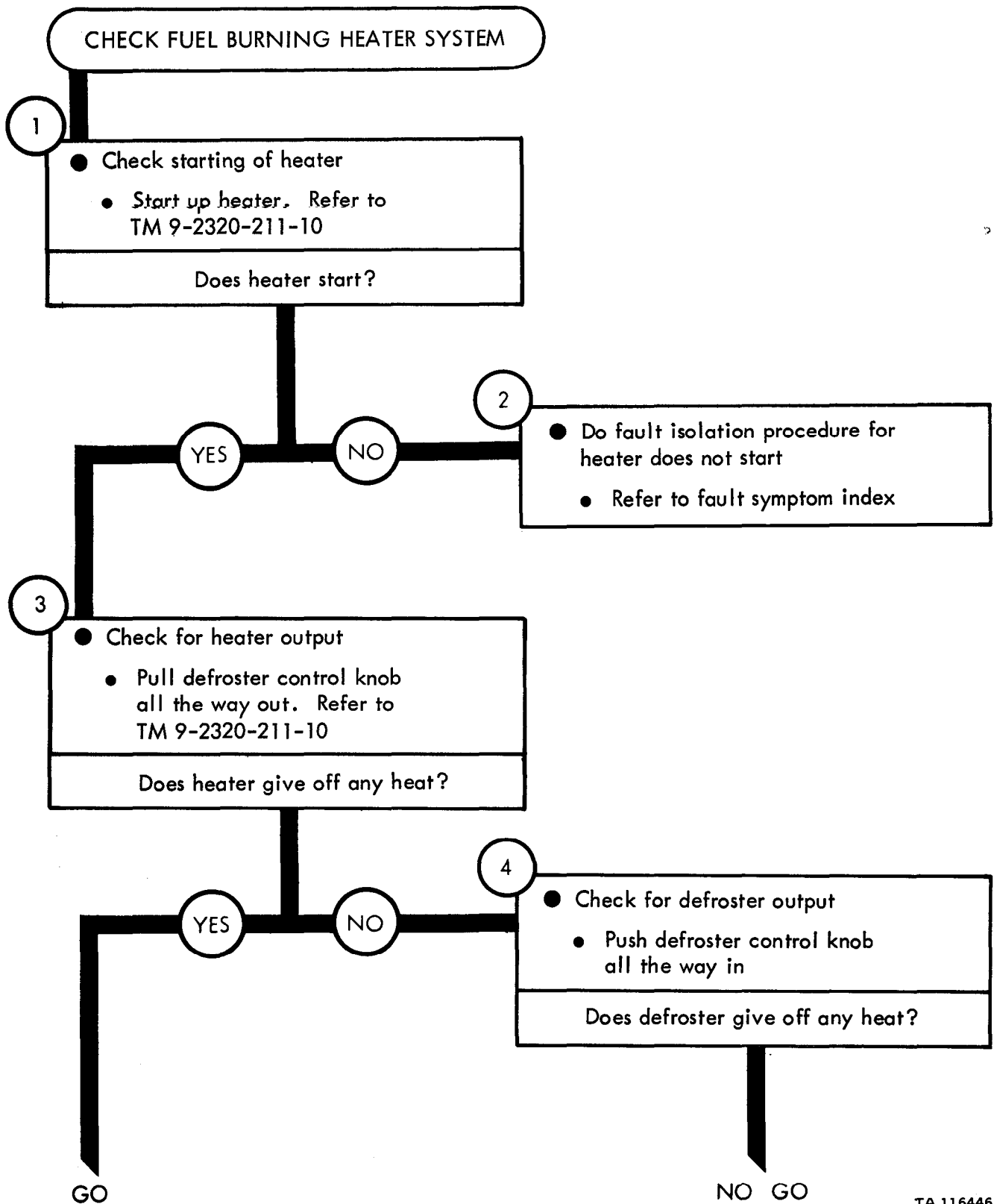

Figure 83-1 (Sheet 1 of 4)

TA 116446

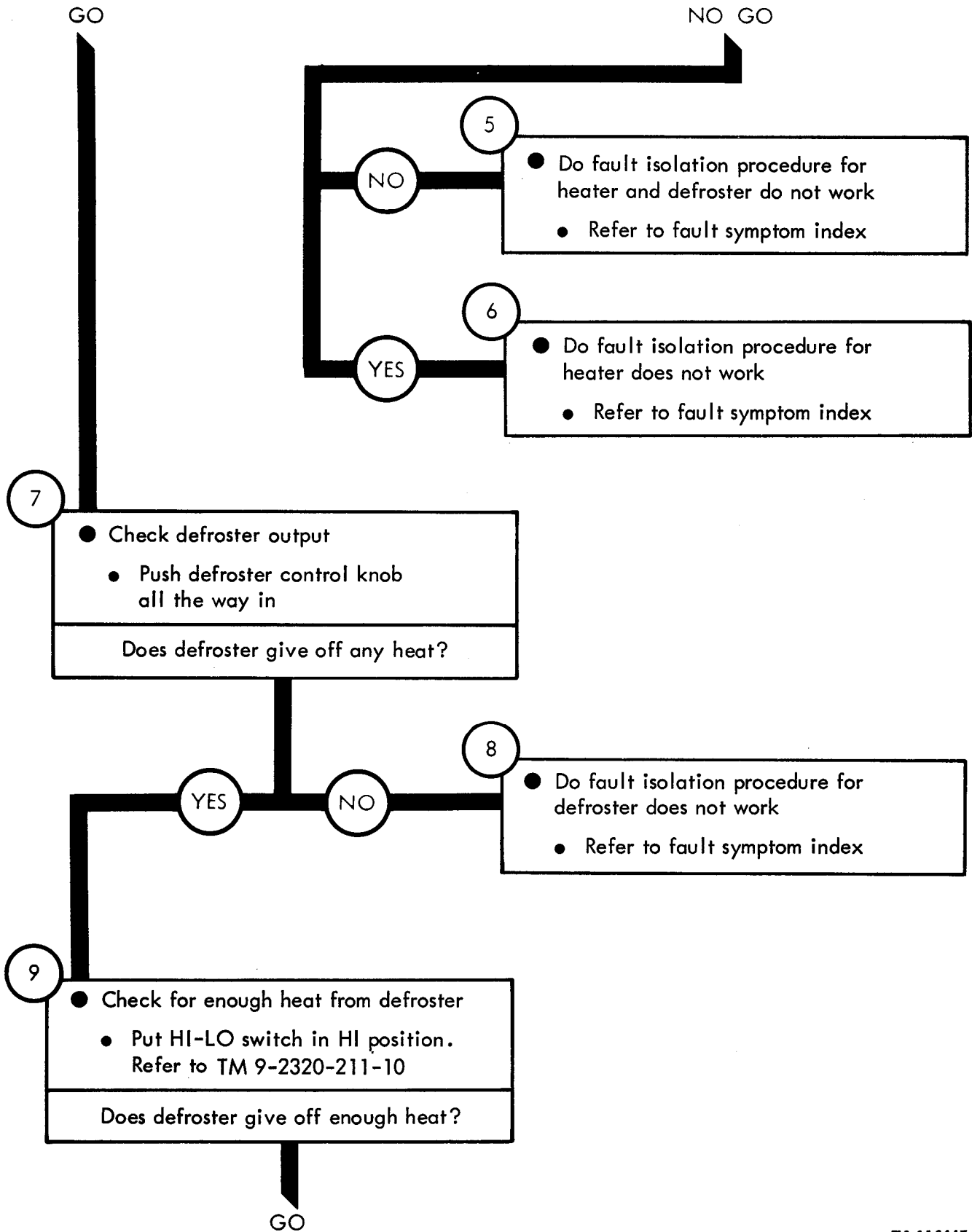

Figure 83-1 (Sheet 2 of 4)

TA 116447

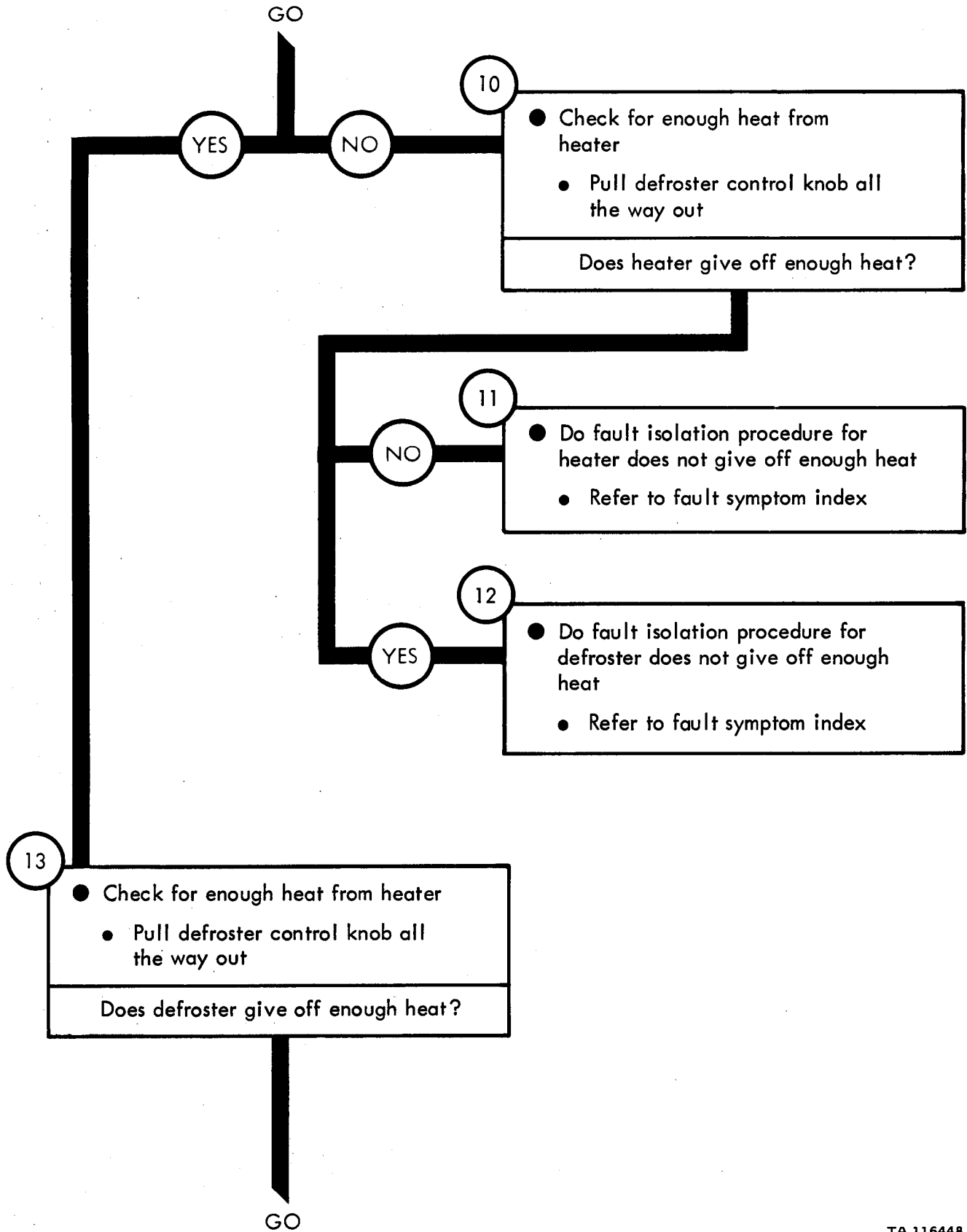
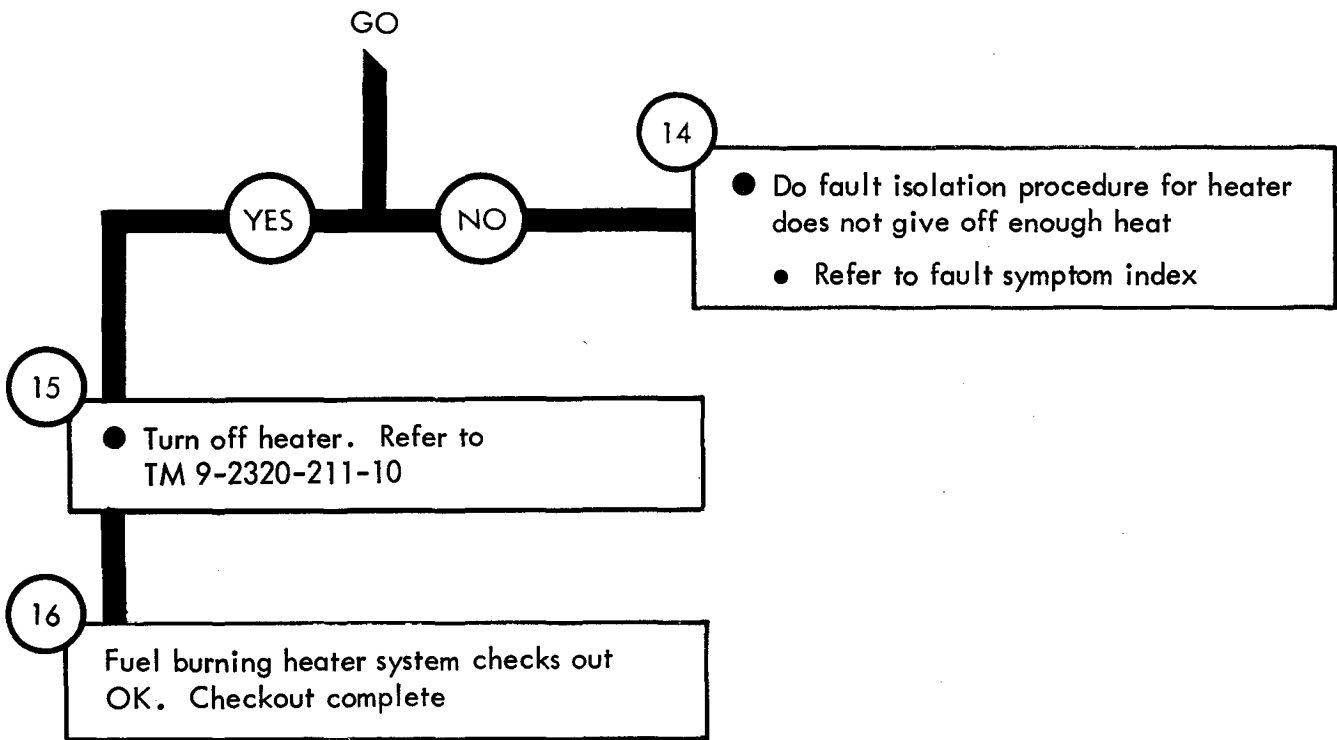

Figure 83-1 (Sheet 3 of 4)



TA 115284

Figure 83-1 (Sheet 4 of 4)

CHAPTER 84

HOT WATER HEATER SYSTEM TROUBLESHOOTING

84-1. EQUIPMENT ITEMS COVERED. This chapter gives equipment troubleshooting procedures for the hot water heater system, for which there are authorized corrective maintenance tasks at the organizational maintenance level.

84-2. EQUIPMENT ITEMS NOT COVERED. All equipment items for which corrective maintenance is authorized at the organizational maintenance level are covered in this chapter.

HOT WATER HEATER SYSTEM TROUBLESHOOTING

Symptom

1 COOL OR COLD AIR AT OUTLETS AFTER ENGINE HAS REACHED OPERATING TEMPERATURE

1

- Park truck
- Refer to TM 9-2320-211-10

2

- Check shut off cocks
- Open hood. Refer to TM 9-2320-211-10
- Check if shut off cocks are fully open to the left

Are shut off cocks fully open to left?

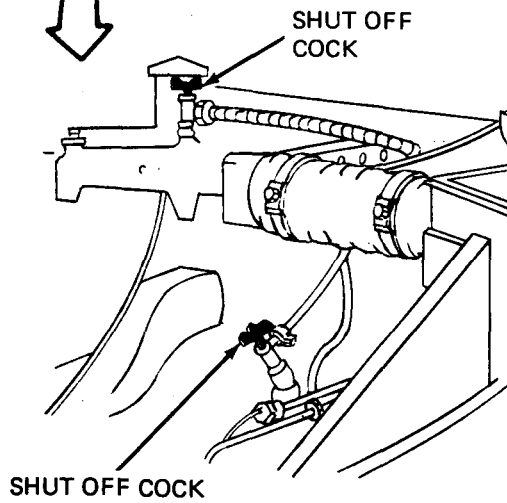
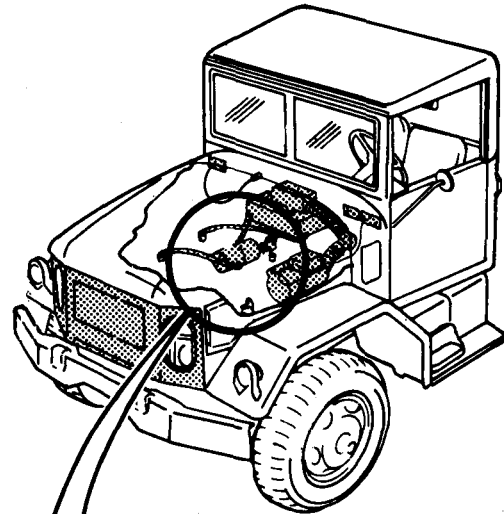

GO

Figure 84-1 (Sheet 1 of 2)

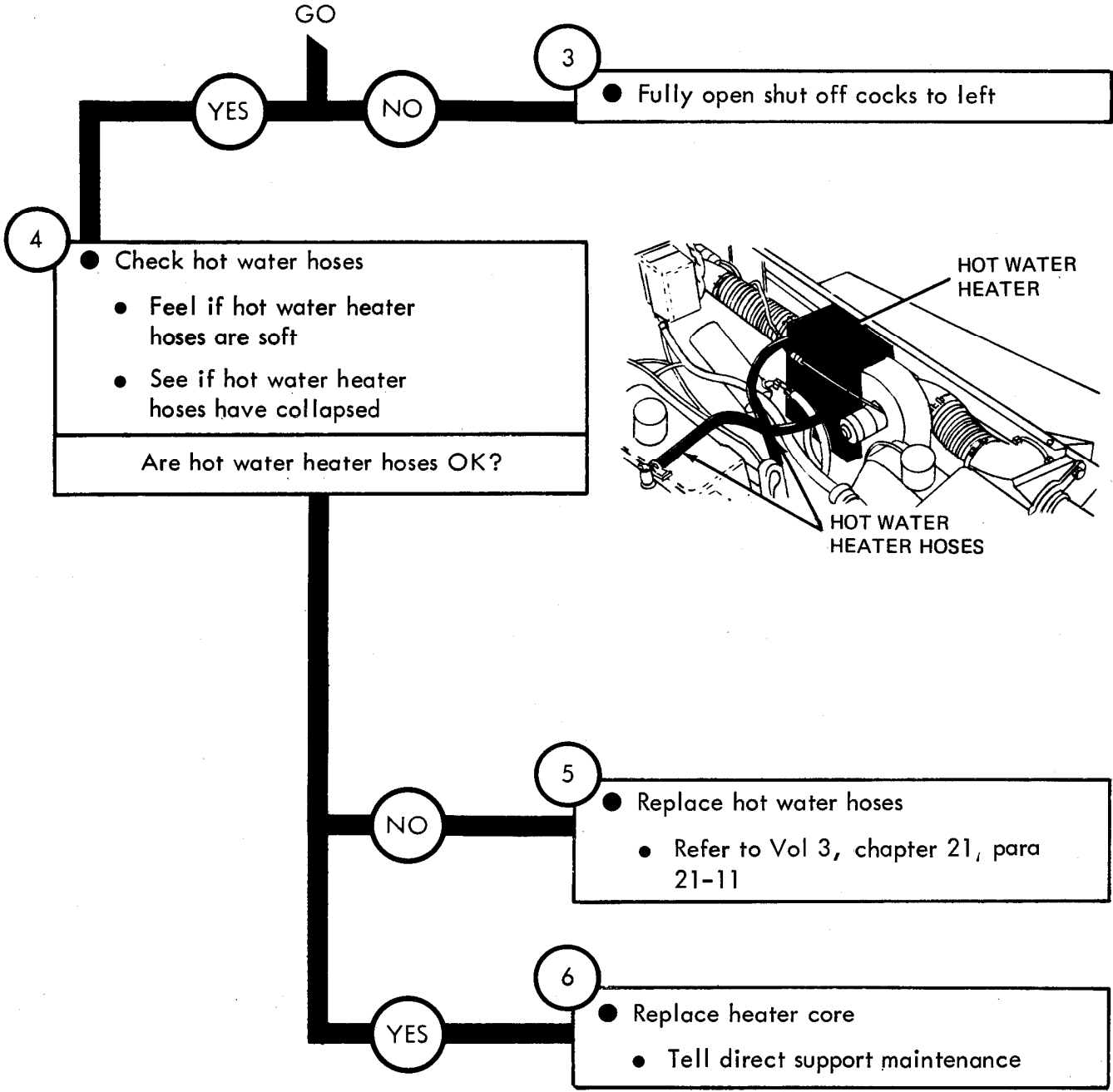

Figure 84-1 (Sheet 2 of 2)

Symptom

2 NO AIR FLOW AT DEFROSTER

1

- Park truck
- Refer to TM 9-2320-211-10

2

- Check if defroster air duct is hanging loose at windshield defroster nozzle
- Under dash panel, look and see if defroster air duct is attached to nozzle

Is defroster air duct attached to nozzle?

GO

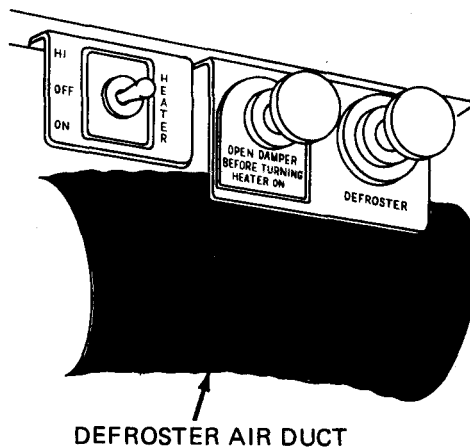
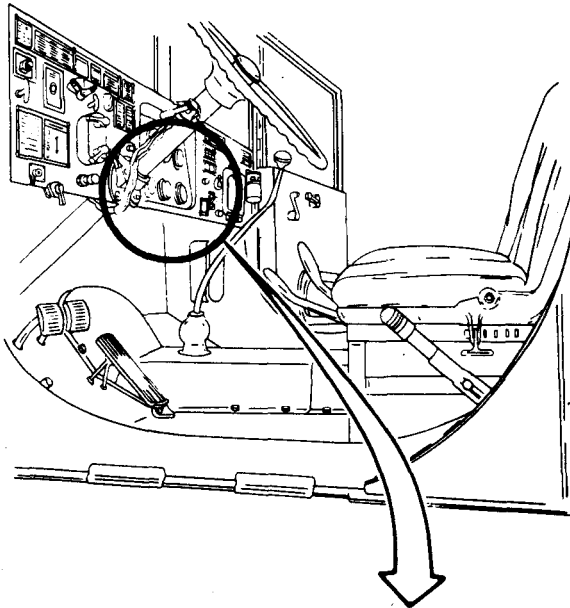
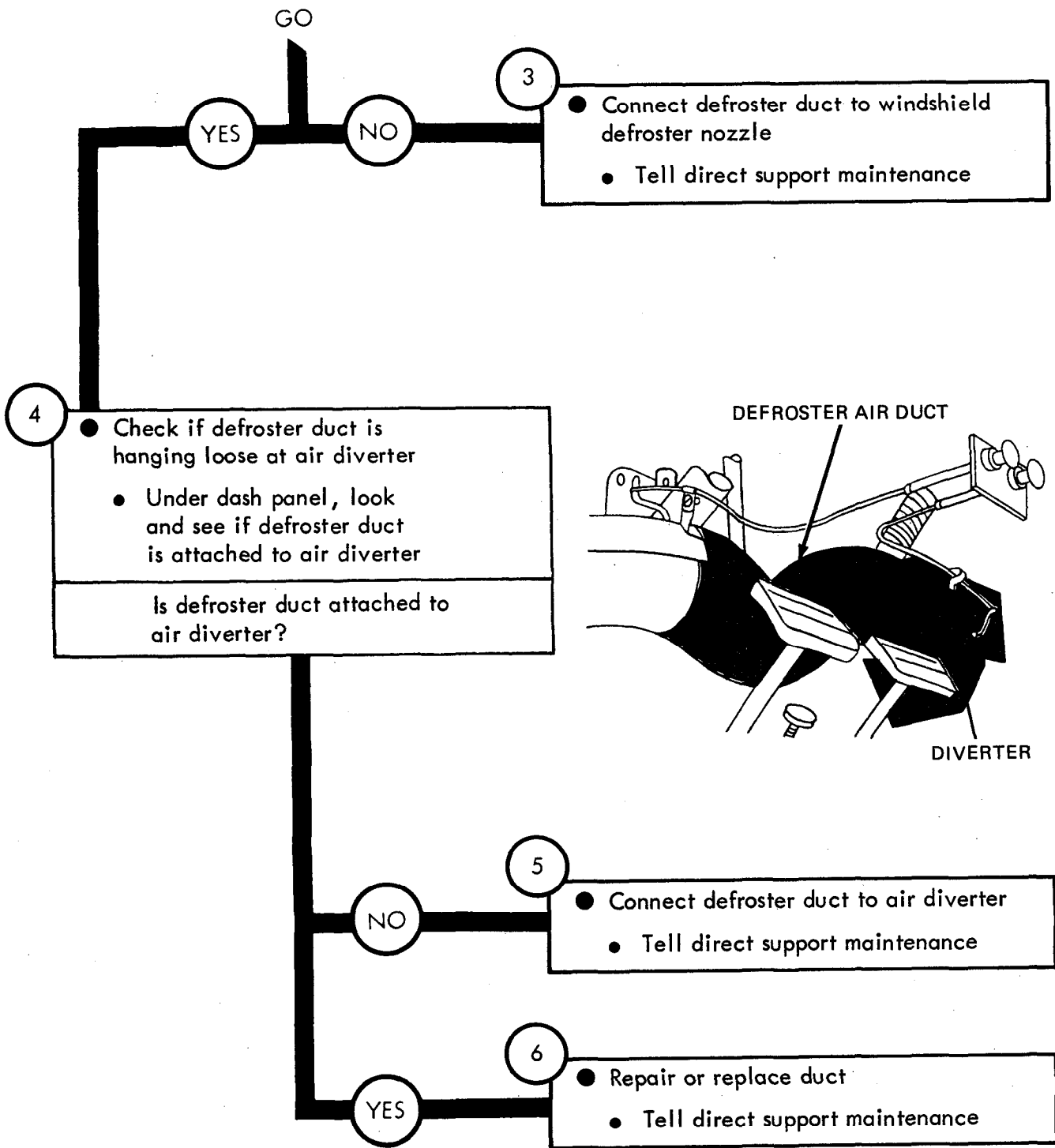

Figure 84-2 (Sheet 1 of 2)

TA 116451



TA 116452

Figure 84-2 (Sheet 2 of 2)

Symptom

3 NO AIR FLOW AT HEAT OUTLET

1

- Park truck
- Refer to TM 9-2320-211-10

2

- Check if heater to air diverter duct is hanging loose
- Look under dash and check if heater to air diverter duct is hanging loose from heater or air diverter

Is heater to air diverter duct attached to heater and air diverter?

NO

3

- Connect heater to air diverter duct
- Tell direct support maintenance

YES

4

- Repair or replace duct
- Tell direct support maintenance

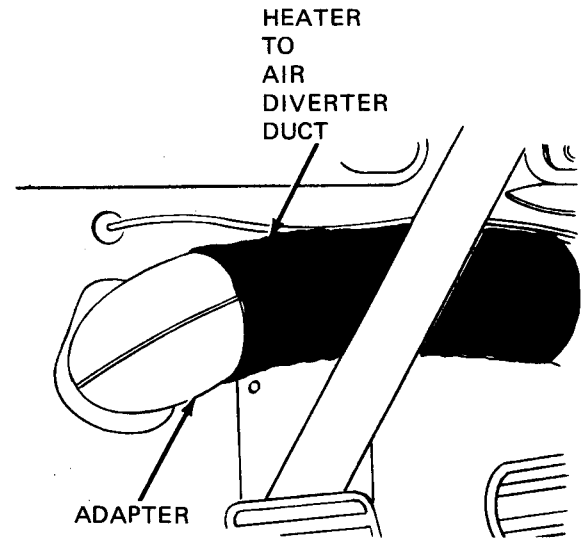
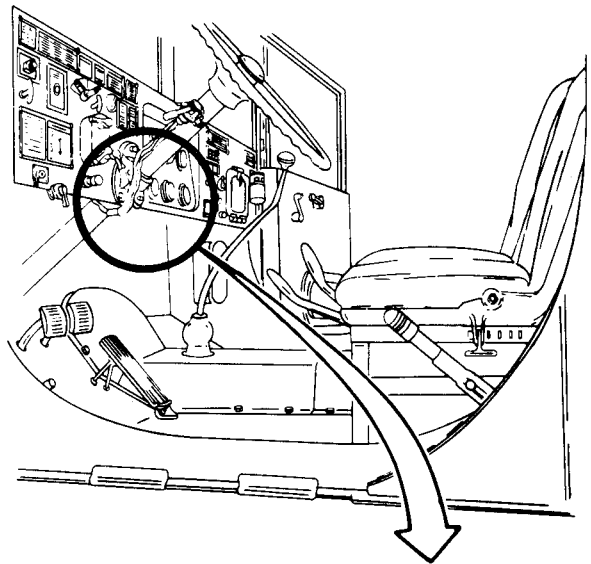

Figure 84-3

Symptom

4

BLOWER OPERATES IN "LO" ONLY

1

- Park truck
- Refer to TM 9-2320-211-10

2

- Check if heater switch lead is attached
- Look under dash panel and see if heater switch lead is attached

Is heater switch lead attached?

NO

3

- Attach heater switch lead
- Refer to Vol 3, chapter 21, para 21-6

YES

4

- Check electrical system
- Refer to fault system index

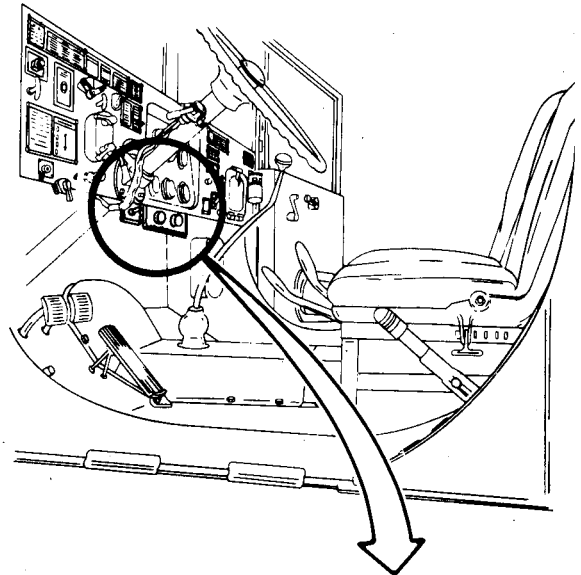

HEATER SWITCH

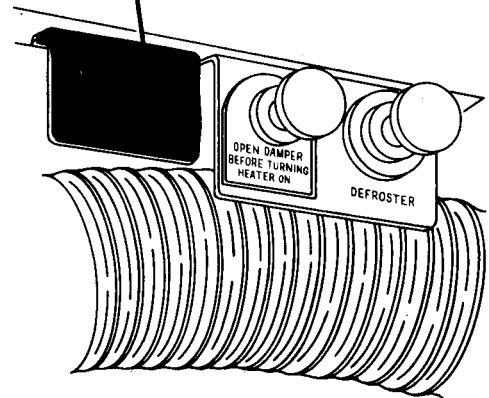

Figure 84-4

Symptom

5

BLOWER MOTOR DOES NOT WORK

1

- Park truck
- Refer to TM 9-2320-211-10

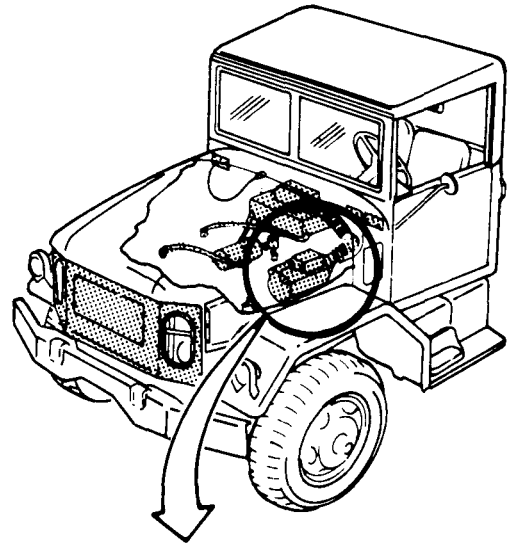

2

- Check lead to blower motor
- Open hood. Refer to TM 9-2320-211-10
- Check if lead to blower motor is attached

Is lead to blower motor attached?

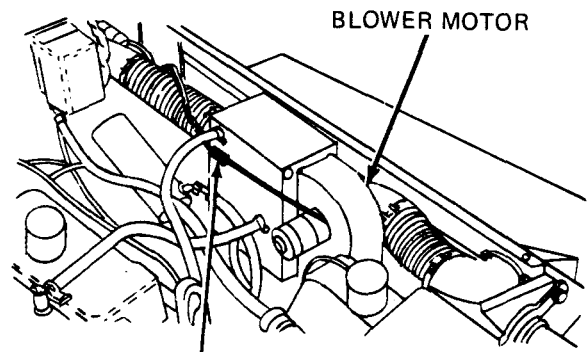

LEAD CONNECTOR

3

- Attach lead to blower motor
- Push lead to blower motor into harness connector

YES

NO

4

- Check electrical system
- Refer to fault symptom index

Figure 84-5

Symptom

6 HEAT OUTPUT TOO LOW

1

- Park truck
- Refer to TM 9-2320-211-10

2

- Check shut off cocks
- Open hood. Refer to TM 9-2320-211-10
- Check if shut off cocks are fully open to the left

Are shut off cocks fully open to left?

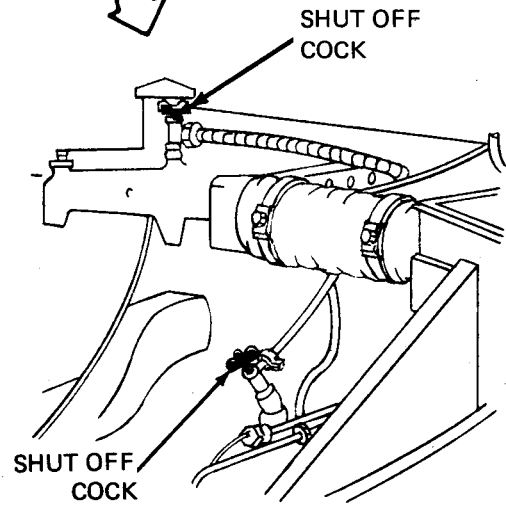
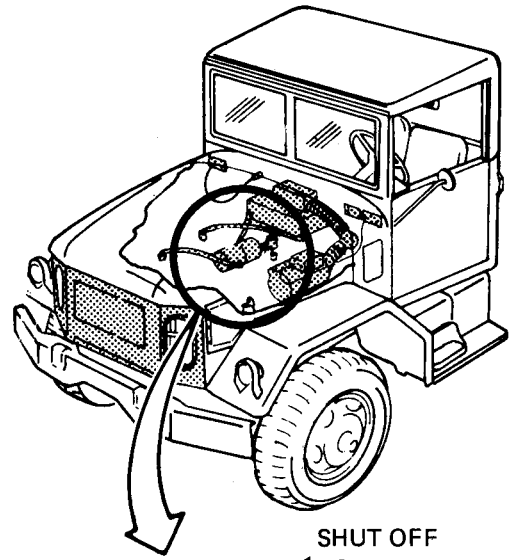

YES NO

3

- Fully open shut off cocks to left

4

- Check electrical system
- Refer to fault symptom index

Figure 84-6

Symptom

7

BLOWER MOTOR OPERATES ON "HI" ONLY

- 1
- Park truck
 - Refer to TM 9-2320-211-10

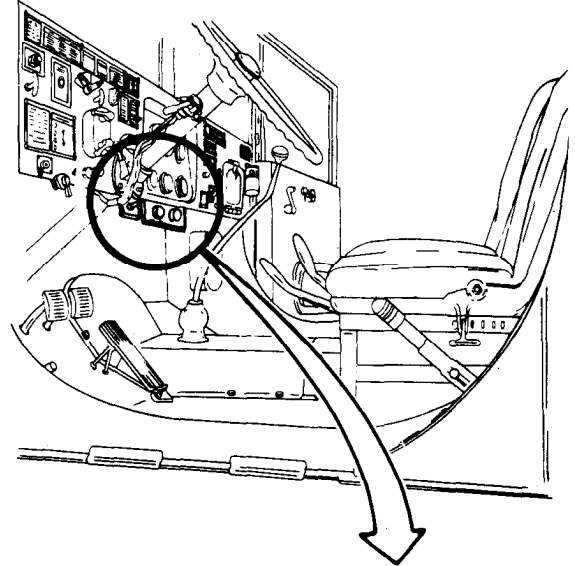

- 2
- Check if heater switch lead is attached
 - Look under dash panel and see if heater switch lead is attached
- Is heater switch lead attached?

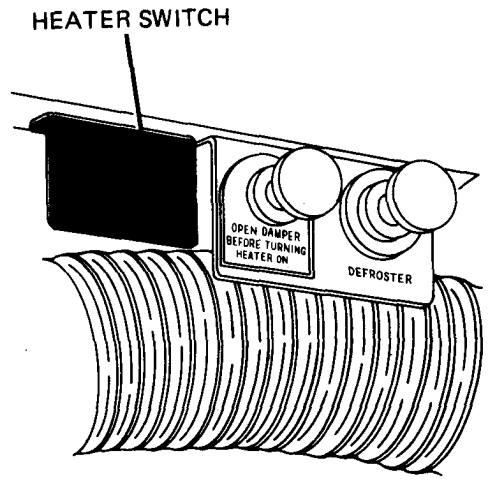

- YES
- NO
- 3
- Attach heater switch lead
 - Refer to Vol 3, chapter 21, para 21-6

- 4
- Check electrical system
 - Refer to fault symptom index

Figure 84-7

CHAPTER 85

HOT WATER HEATER SYSTEM

TROUBLESHOOTING SUMMARY

85-1. GENERAL. This chapter gives a summary of troubleshooting procedures given in chapter 84, for the Hot Water Heater System.

85-2. PROCEDURES . The summary in this chapter covers all fault symptoms found in the detailed troubleshooting procedures in Part 1. Chapter 7 outlines a sample troubleshooting procedure. The summary procedures are based on the "what-to-do" portions of the detailed procedures and do not include the "How-to-do-it" instructions. Warnings, cautions, and notes are given where needed.

HOT WATER HEATER SYSTEM SUMMARY TROUBLESHOOTING

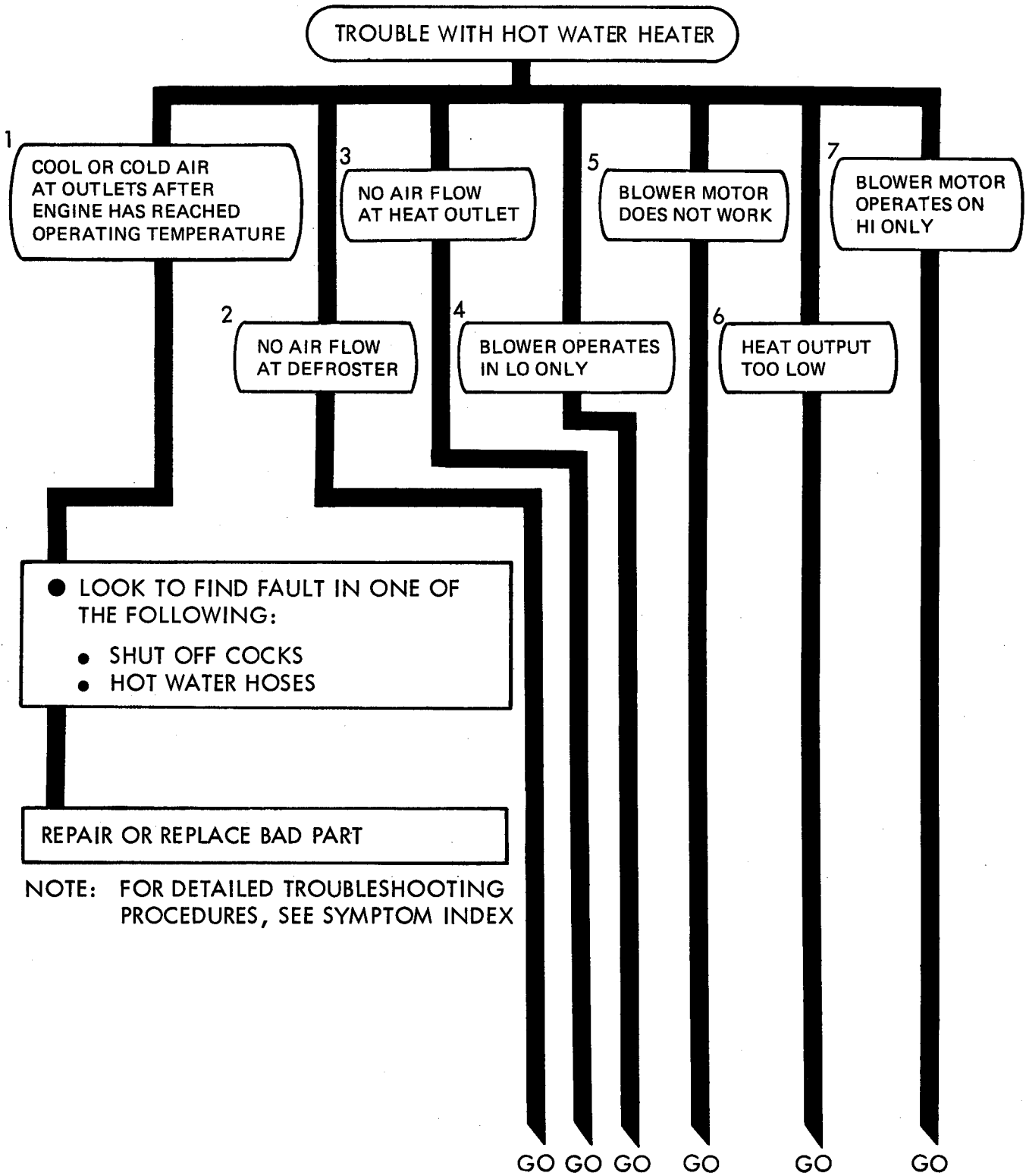

Figure 85-1 (Sheet 1 of 6)

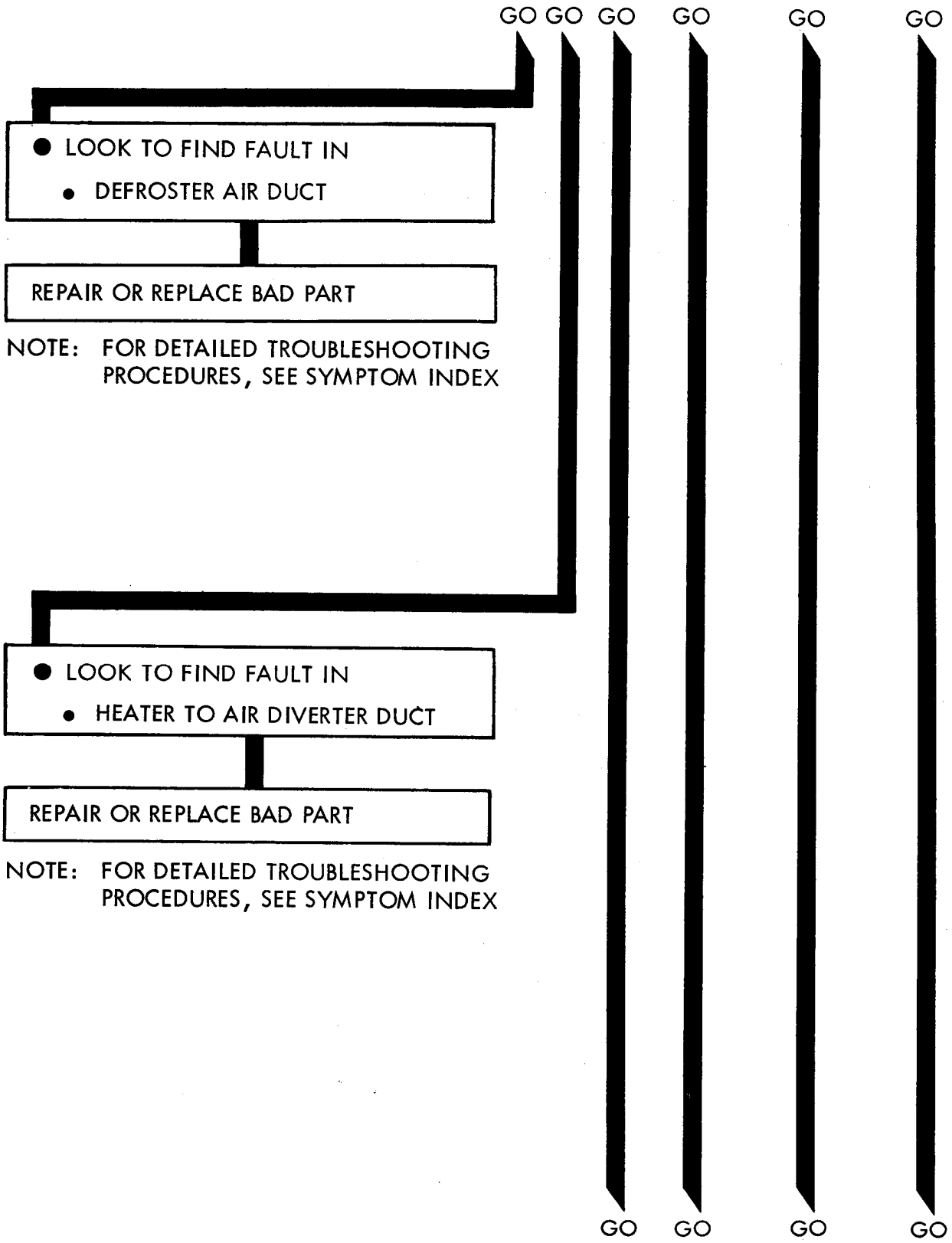
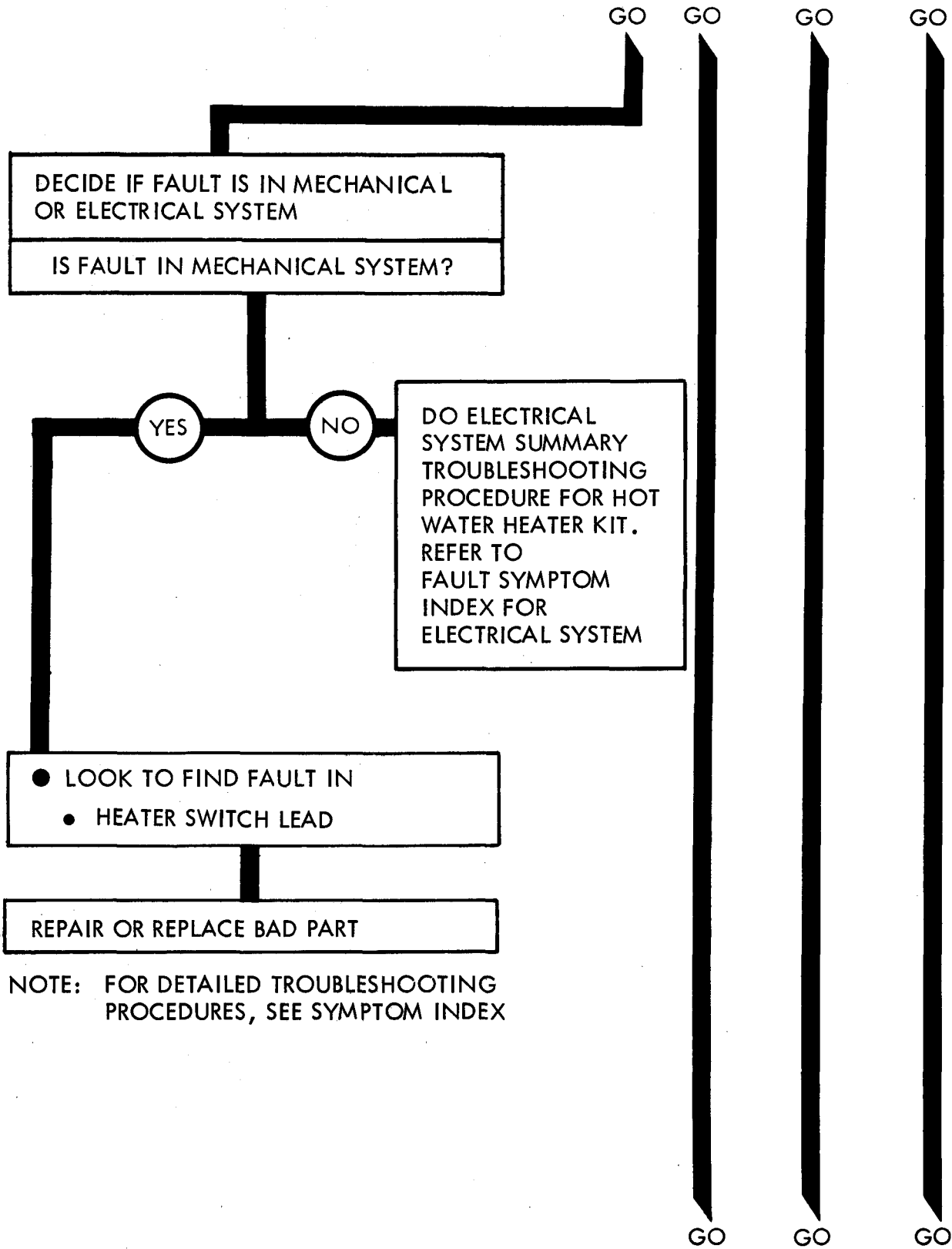
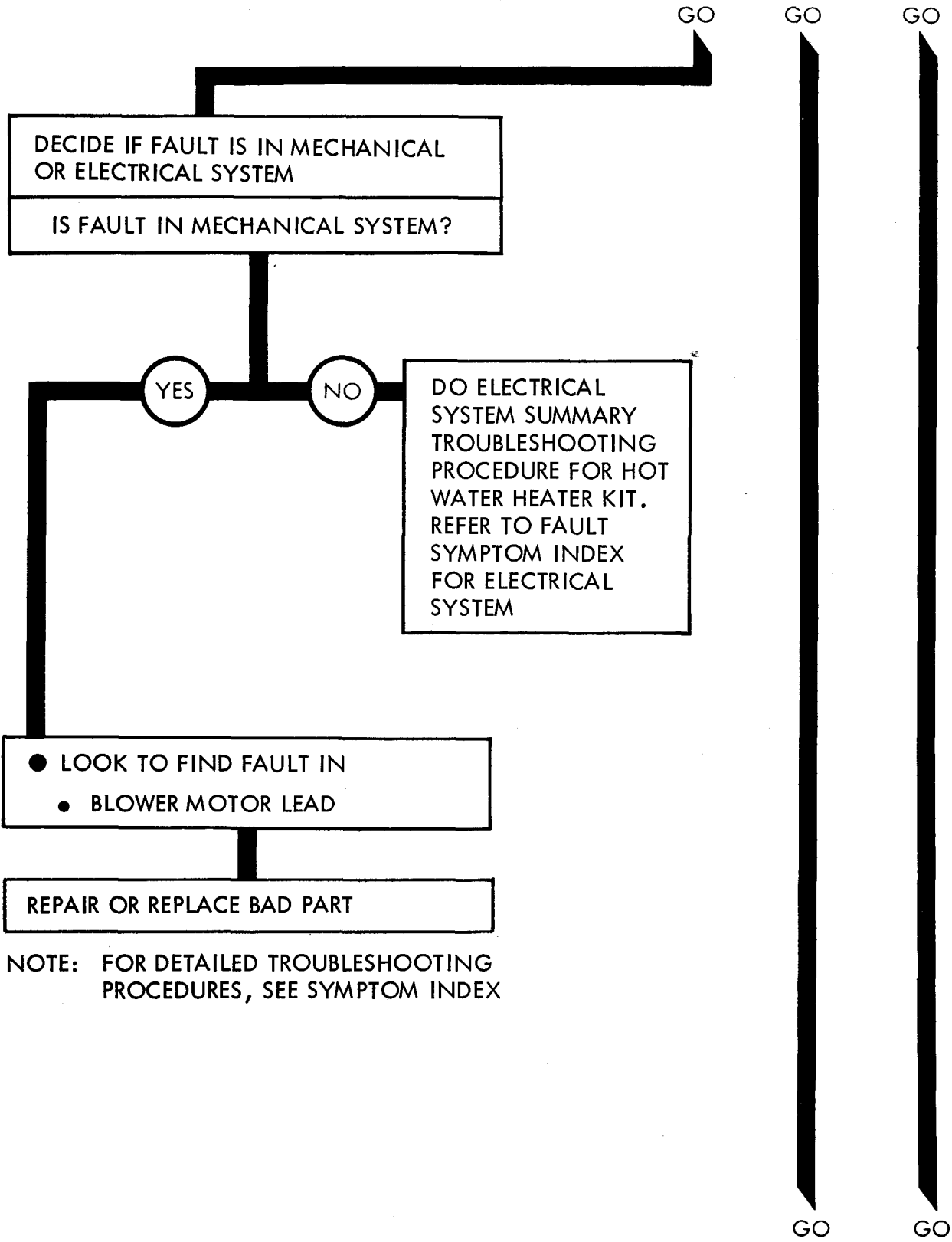

Figure 85-1 (Sheet 2 of 6)



NOTE: FOR DETAILED TROUBLESHOOTING PROCEDURES, SEE SYMPTOM INDEX

Figure 85-1 (Sheet 3 of 6)



NOTE: FOR DETAILED TROUBLESHOOTING PROCEDURES, SEE SYMPTOM INDEX

Figure 85-1 (Sheet 4 of 6)

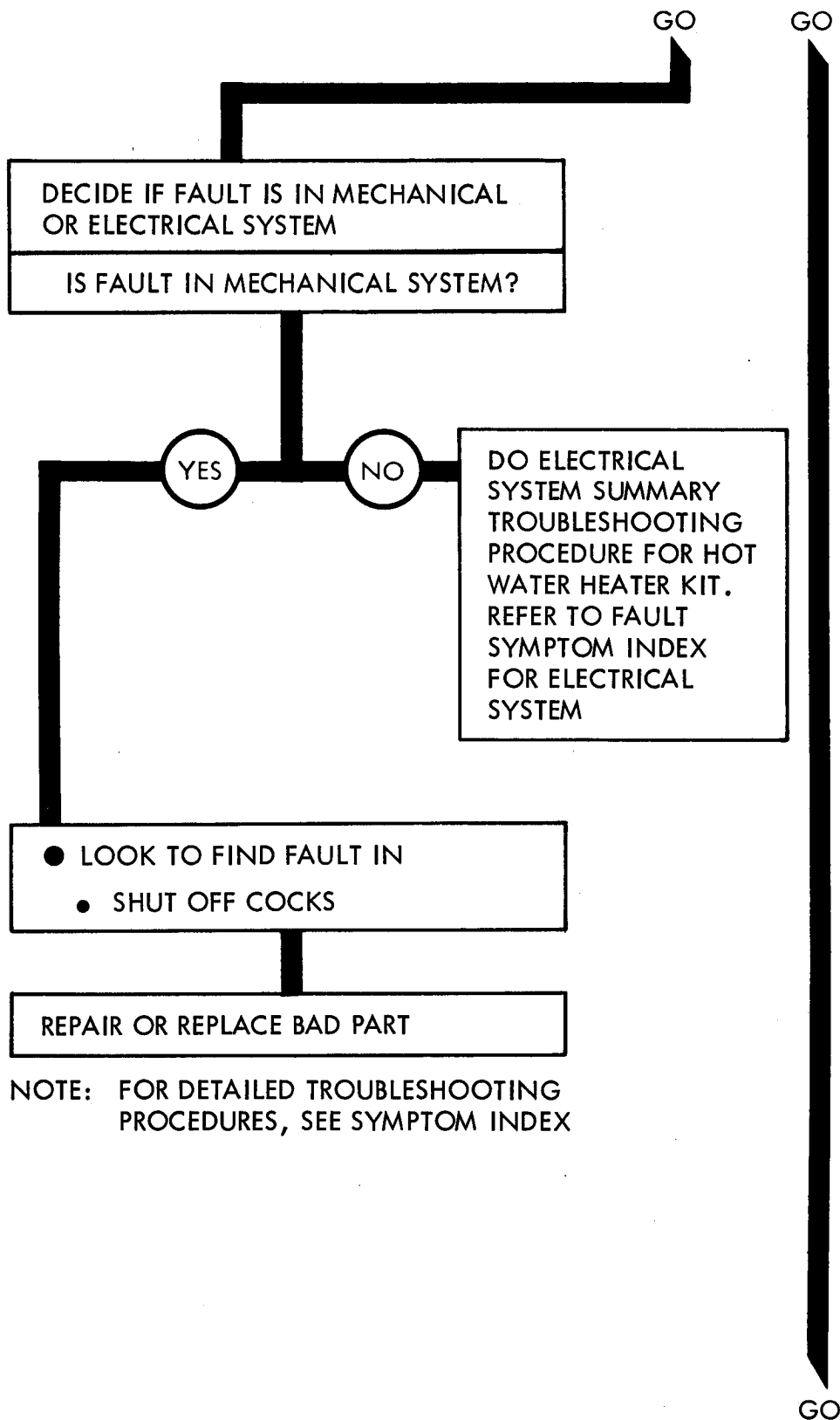

NOTE: FOR DETAILED TROUBLESHOOTING PROCEDURES, SEE SYMPTOM INDEX

Figure 85-1 (Sheet 5 of 6)

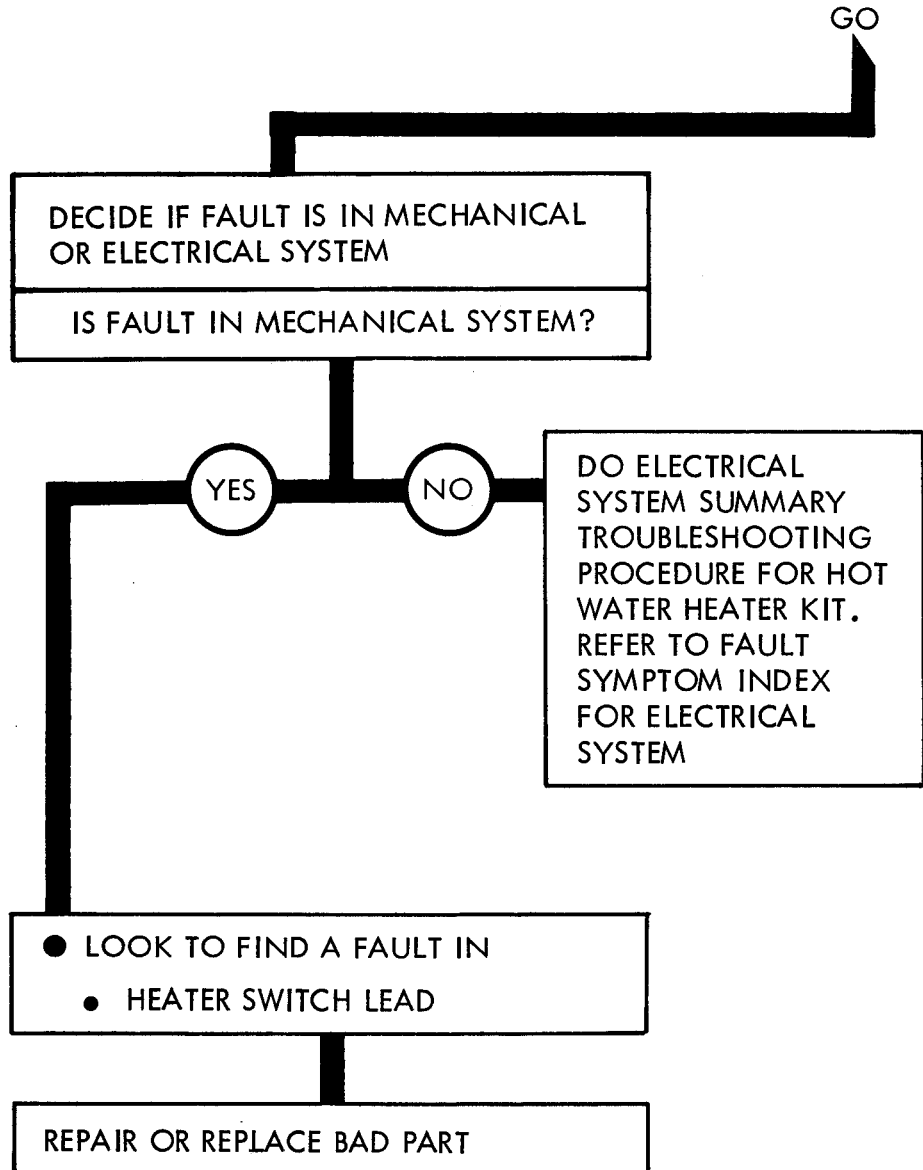

NOTE: FOR DETAILED TROUBLESHOOTING PROCEDURES, SEE SYMPTOM INDEX

CHAPTER 86

HOT WATER HEATER SYSTEM CHECKOUT PROCEDURES

86-1. GENERAL. This chapter gives procedures for checking out the system after troubleshooting and repair have been done. Procedures are set up in flow chart form showing the checkout steps in order and referring to the fault symptom index when the system does not check out.

HOT WATER HEATER SYSTEM CHECKOUT

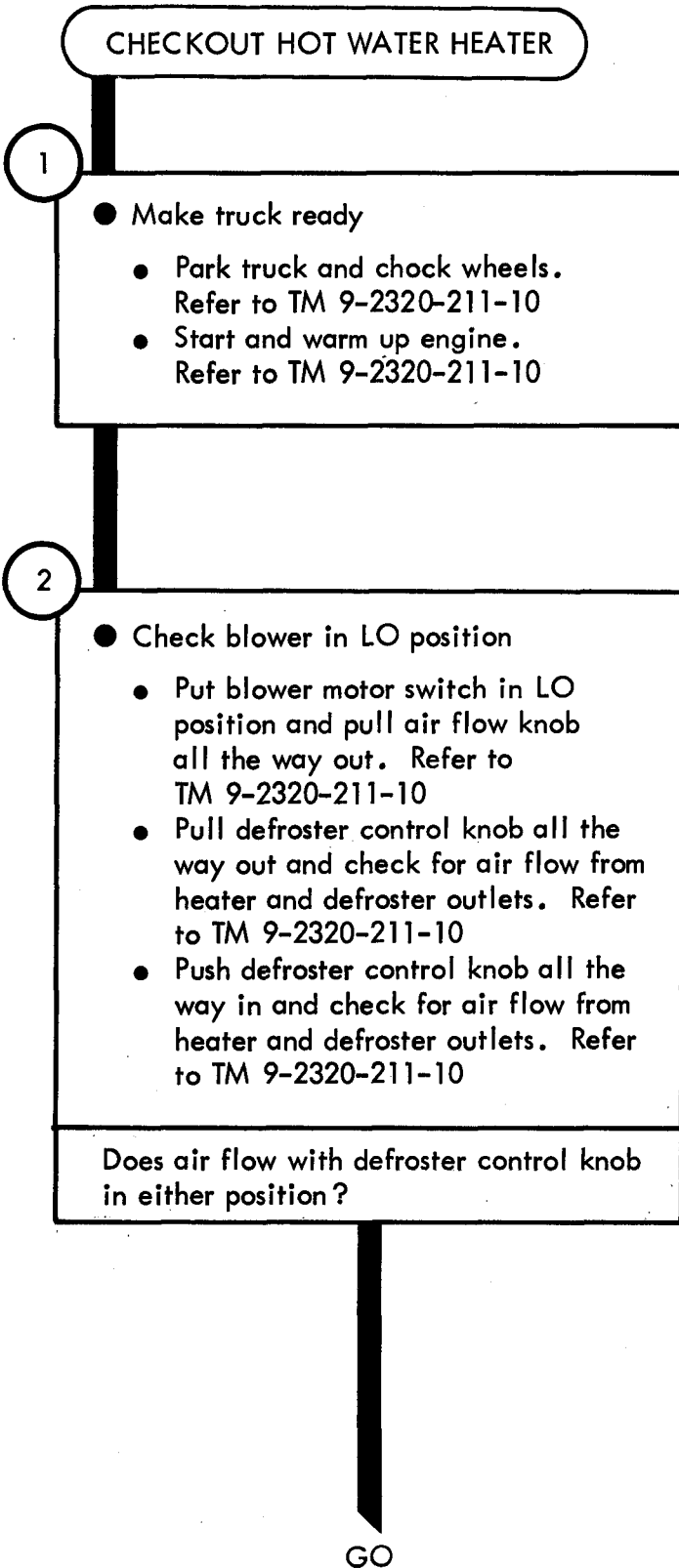

Figure 86-1 (Sheet 1 of 5)

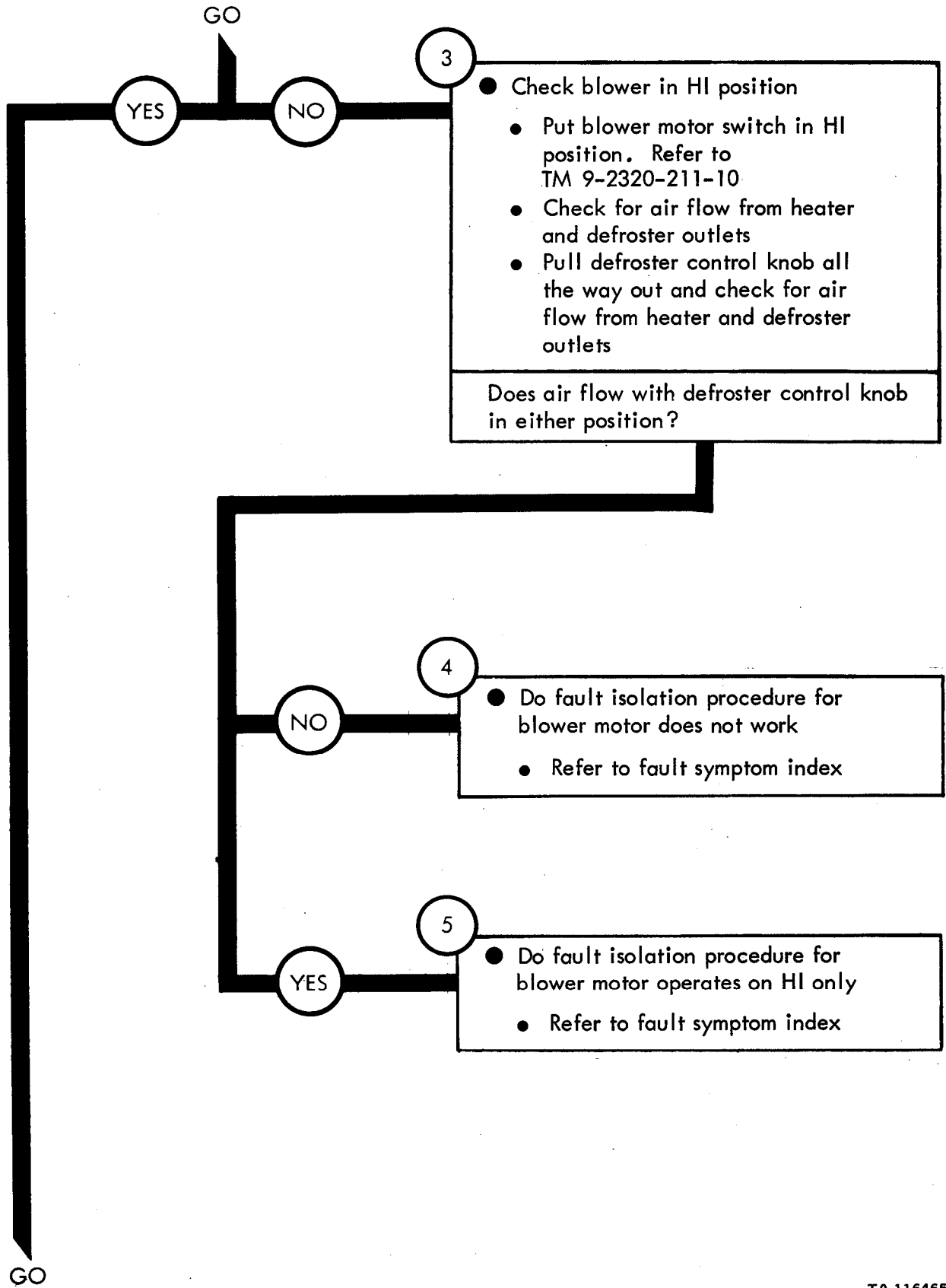
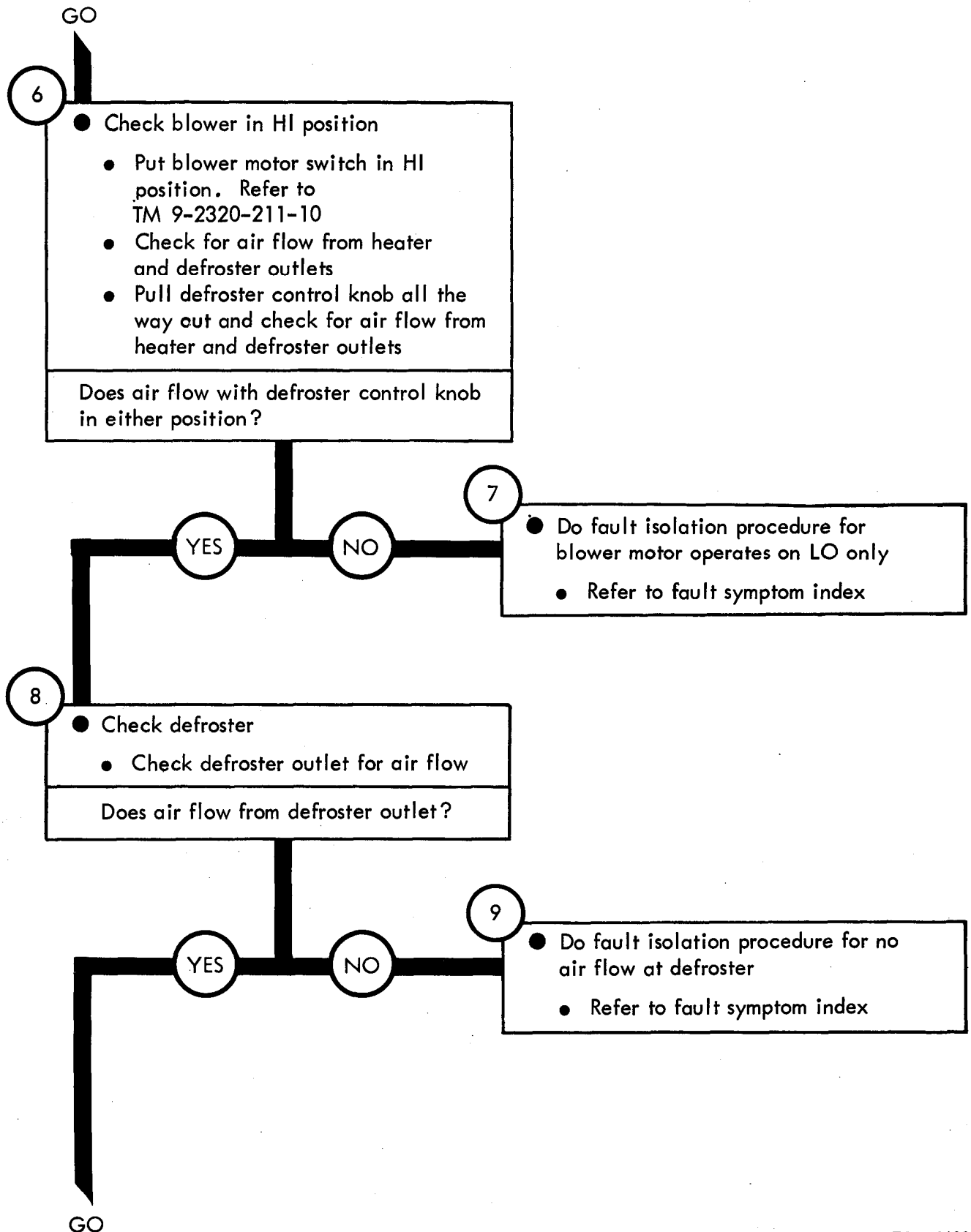

Figure 86-1 (Sheet 2 of 5)



TA 116466

Figure 86-1 (Sheet 3 of 5)

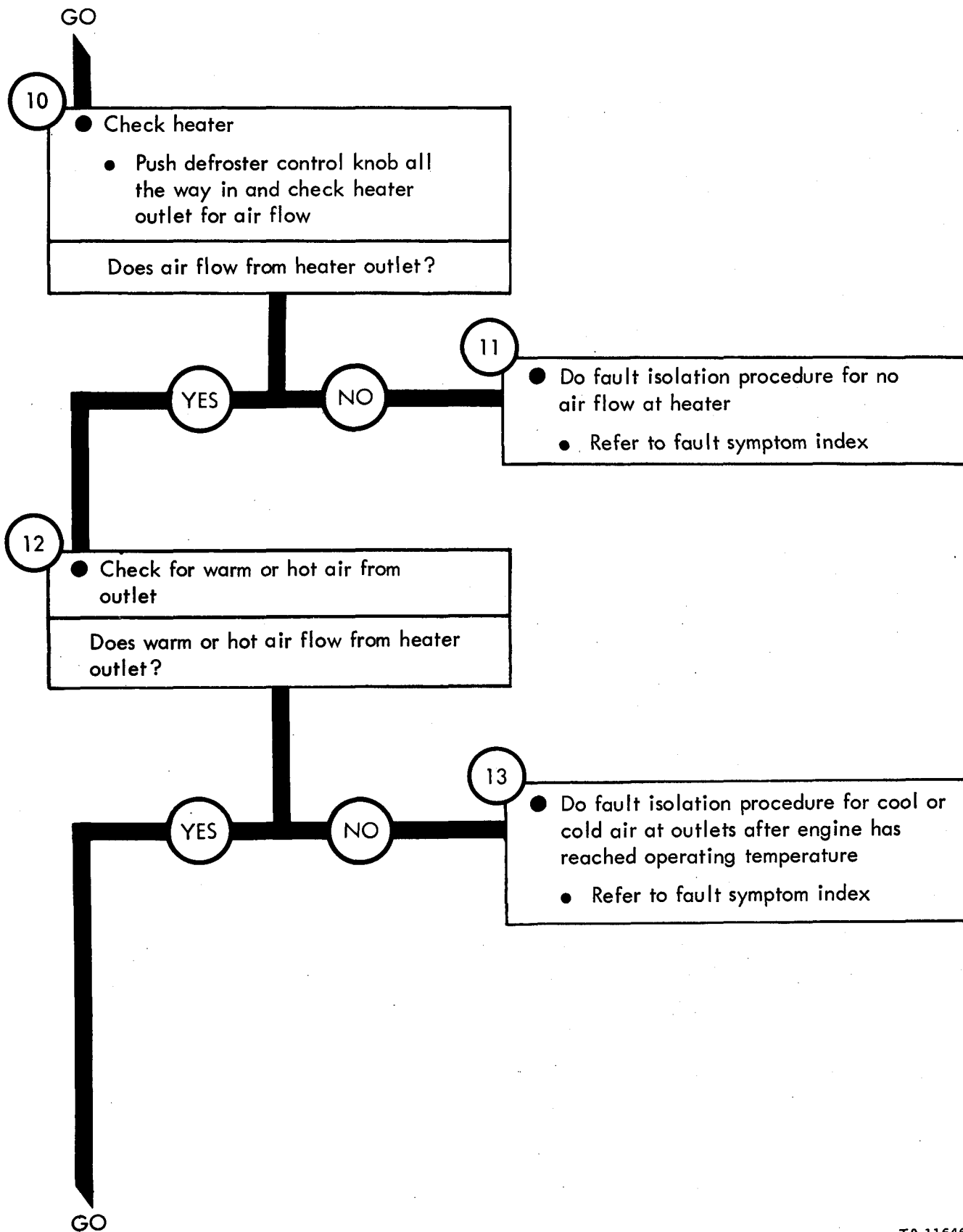

Figure 86-1 (Sheet 4 of 5)

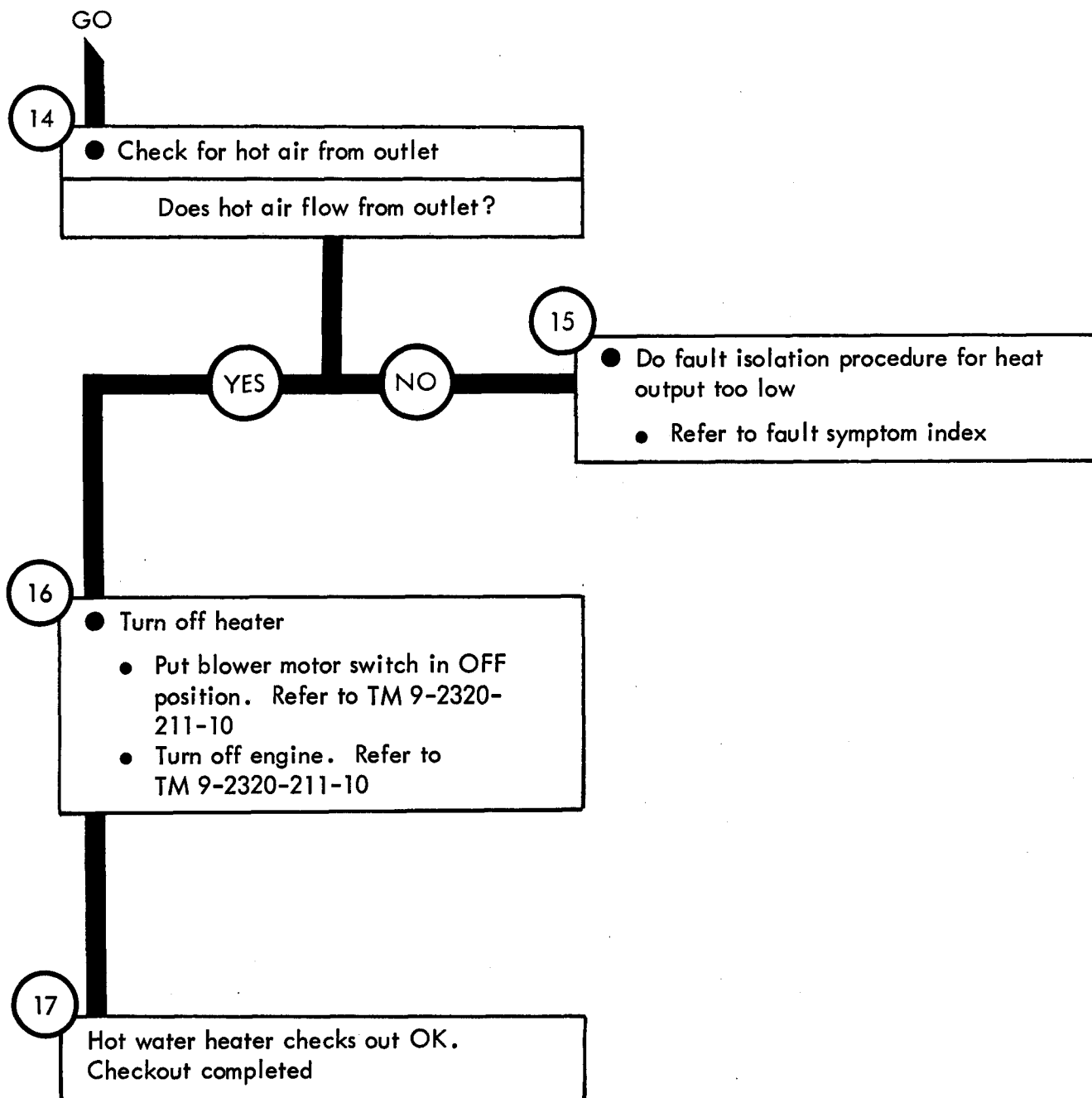

Figure 86-1 (Sheet 5 of 5)

CHAPTER 87

NONELECTRICAL GAGES TROUBLESHOOTING

87-1. EQUIPMENT ITEMS COVERED. This chapter gives equipment troubleshooting procedures for nonelectrical gages, for which there are authorized corrective maintenance tasks at the organizational maintenance level.

87-2. EQUIPMENT ITEMS NOT COVERED. All equipment items for which corrective maintenance is authorized at the organizational maintenance level are covered in this chapter.

NONELECTRICAL GAGES TROUBLESHOOTING

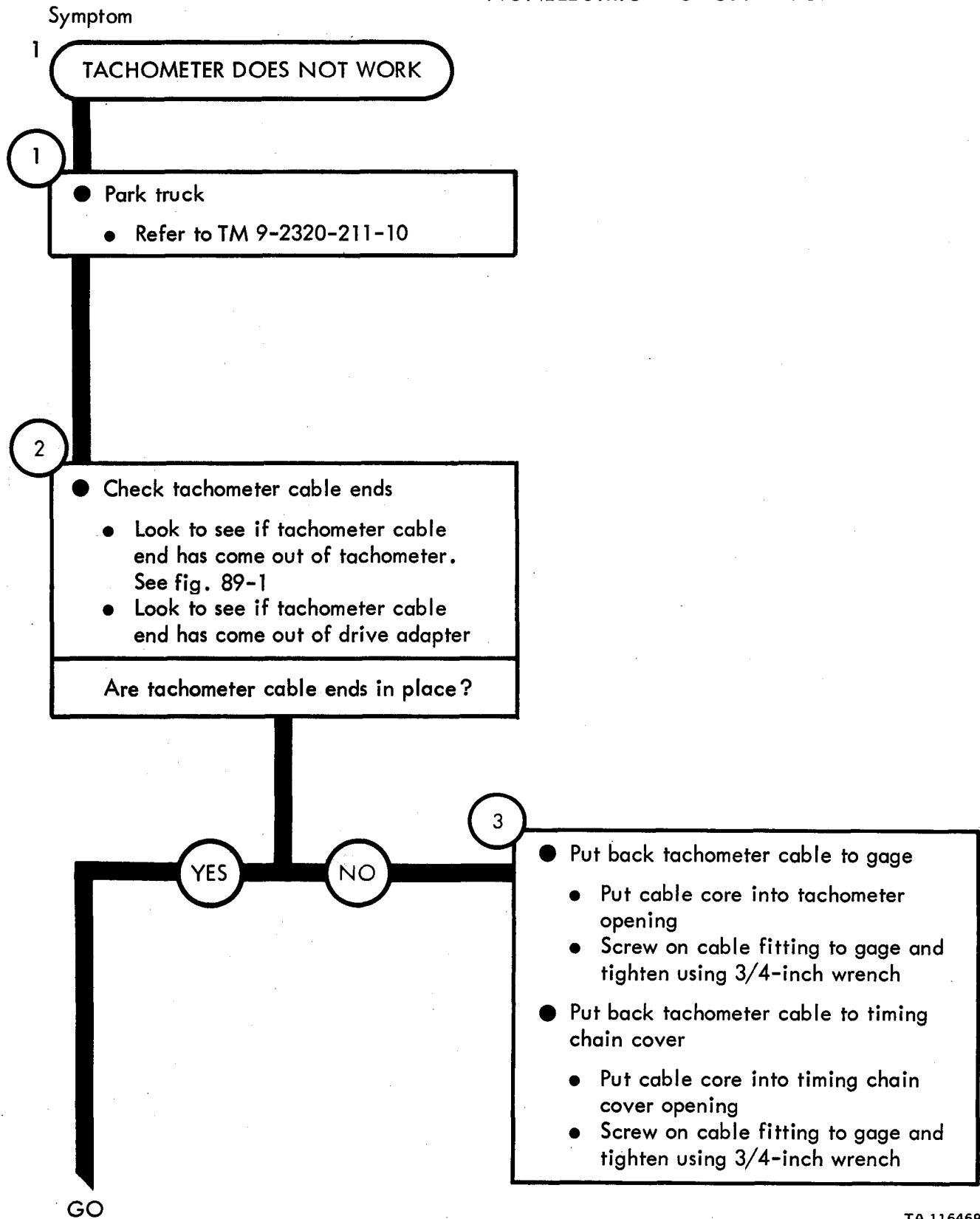

TA 116469

Figure 87-1 (Sheet 1 of 3)

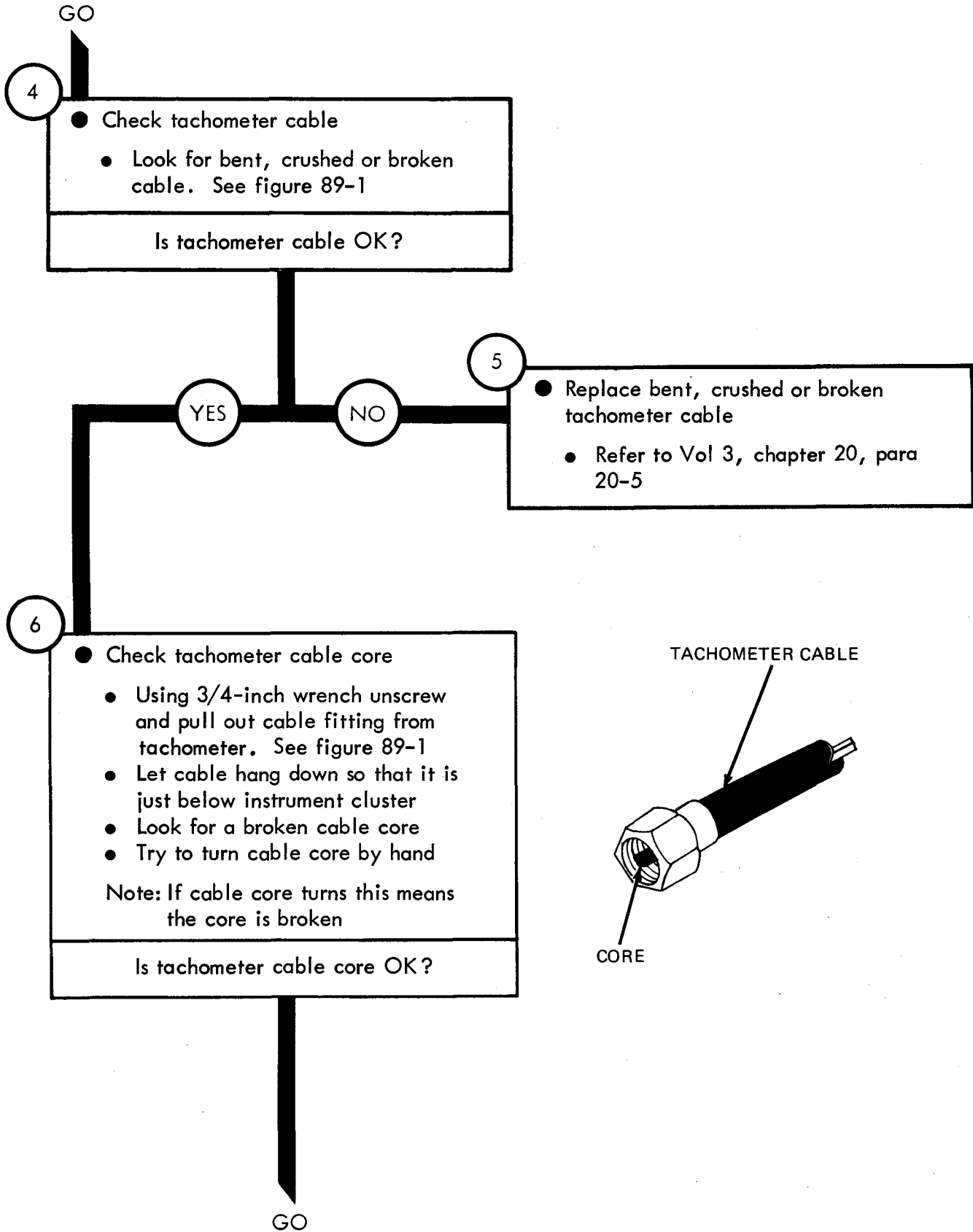

Figure 87-1 (Sheet 2 of 3)

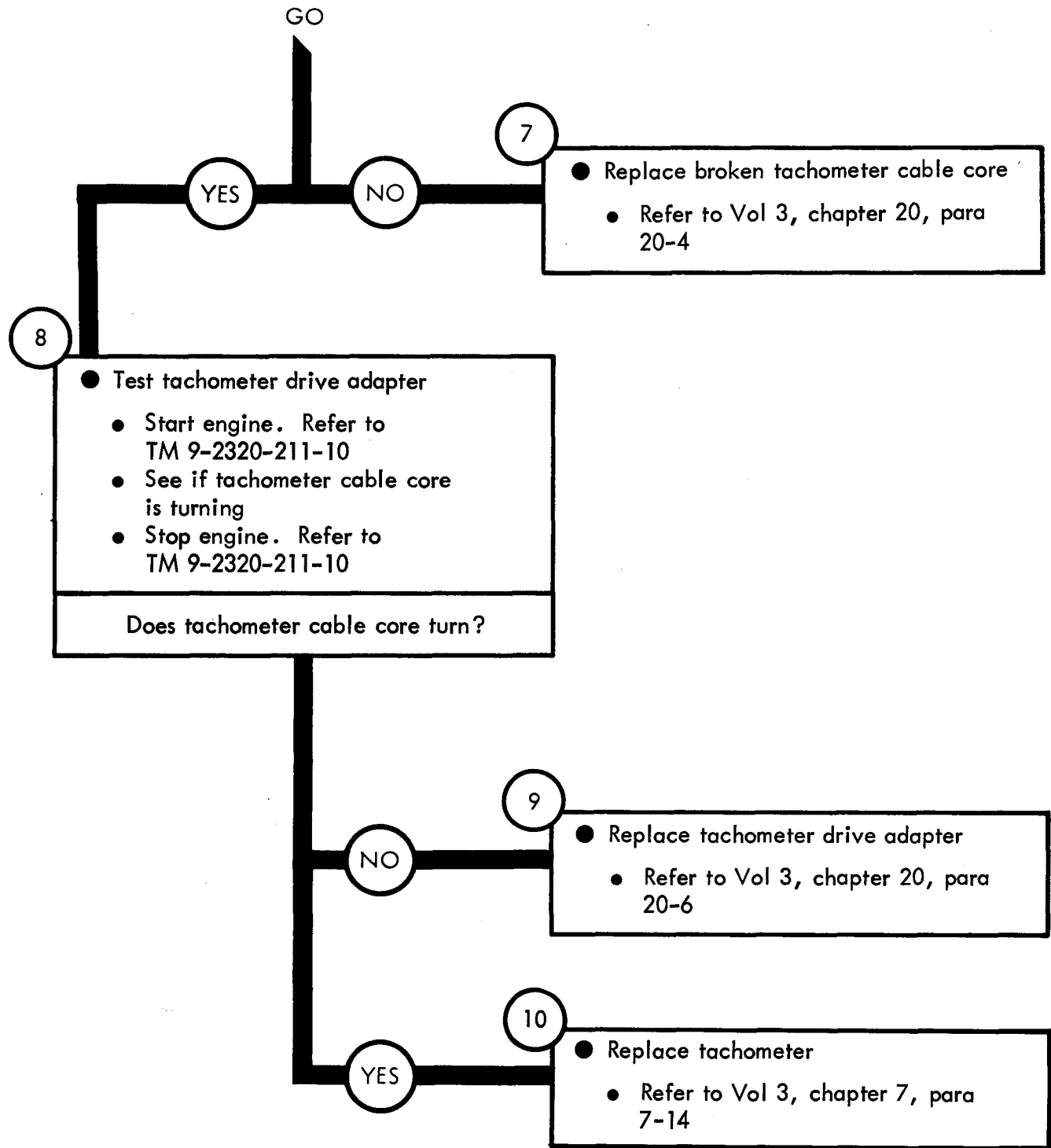
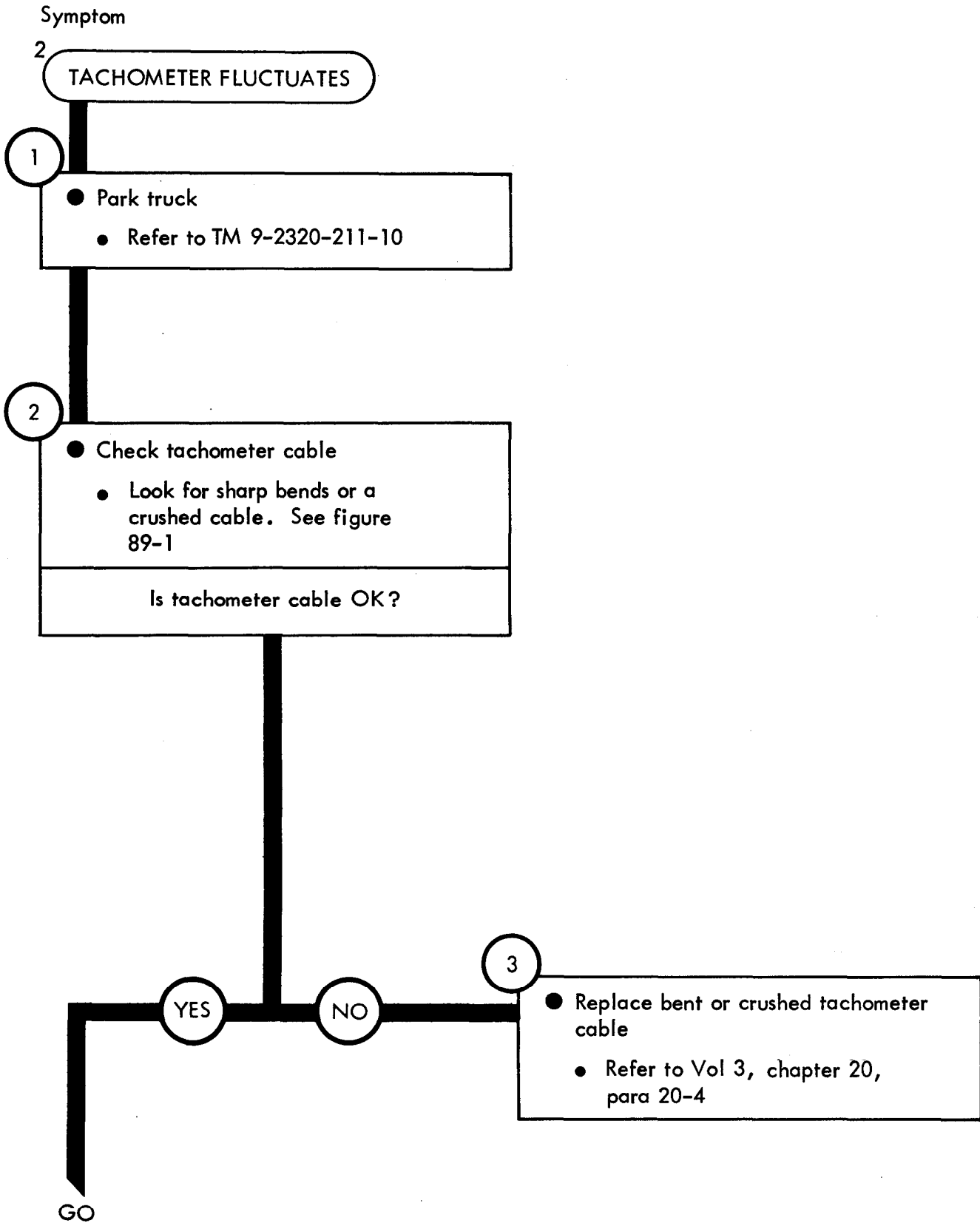

Figure 87-1 (Sheet 3 of 3)



TA 116472

Figure 87-2 (Sheet 1 of 2)

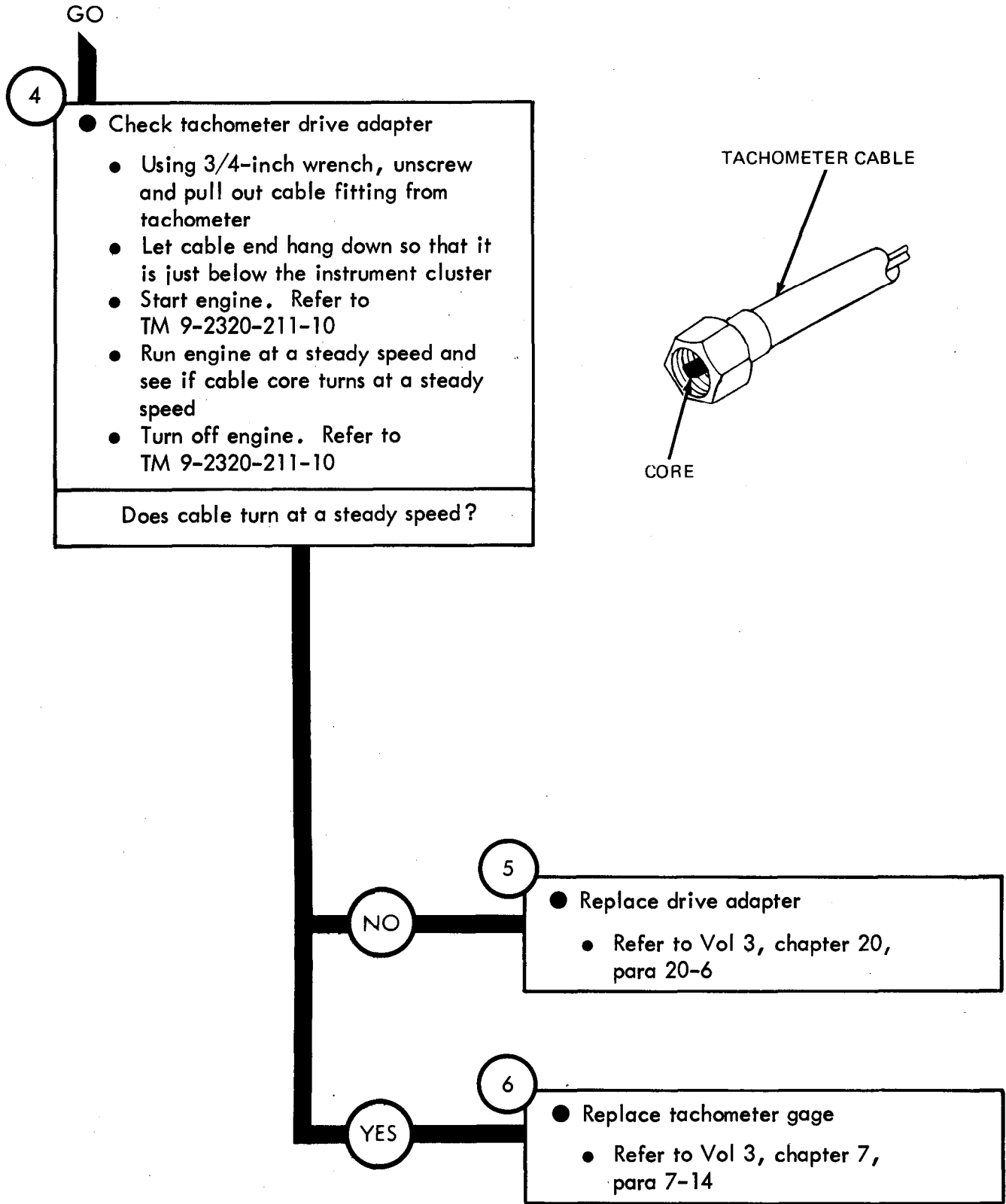

Figure 87-2 (Sheet 2 of 2)

Symptom

3

TACHOMETER DOES NOT SHOW CORRECT READING

1

- Park truck
- Refer to TM 9-2320-211-10

2

- Check tachometer cable
- Look for sharp bends or a crushed cable. See fig. 89-1

Is tachometer cable OK?

YES

NO

3

- Replace bent or crushed tachometer cable
- Refer to Vol 3, chapter 20, para 20-4

GO

TA 116474

Figure 87-3 (Sheet 1 of 4)

GO

4

● Check tachometer

- Start engine and place vehicle in motion. Refer to TM 9-2320-211-10
- Run truck at idle speed and make a note of tachometer gage reading. Refer to TM 9-2320-211-10
- Unscrew and pull out cable fitting from tachometer. See figure 89-1
- Screw cable fitting onto another tachometer that is known to be good

NOTE

The next step will need the use of two soldiers. The lead soldier will be called SOLDIER A and the helper will be called SOLDIER B

GO

TA 116475

Figure 87-3 (Sheet 2 of 4)

GO

SOLDIER B

- Sit in companion seat and hold tachometer being used for test

SOLDIER A

- Start engine. Refer to TM 9-2320-211-10
- Run truck at idle speed and make note of the reading on the tachometer being used for test. Refer to TM 9-2320-211-10
- Unscrew and pull out cable fitting from tachometer

Are both tachometer readings the same?

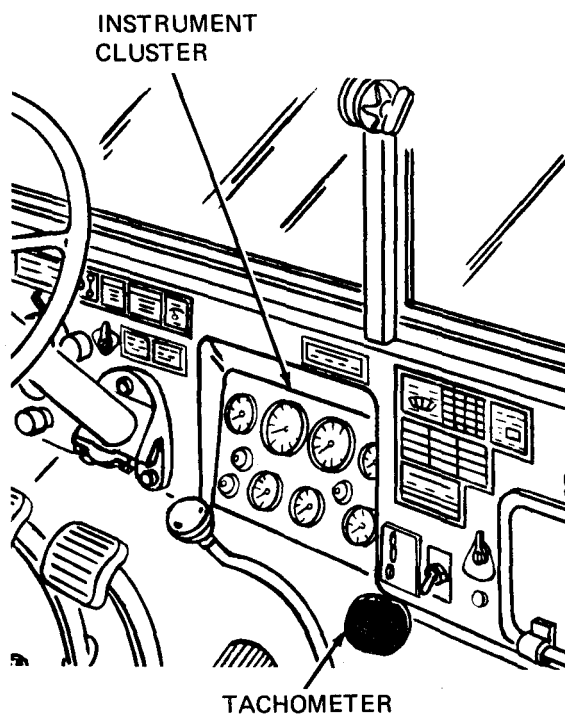

GO

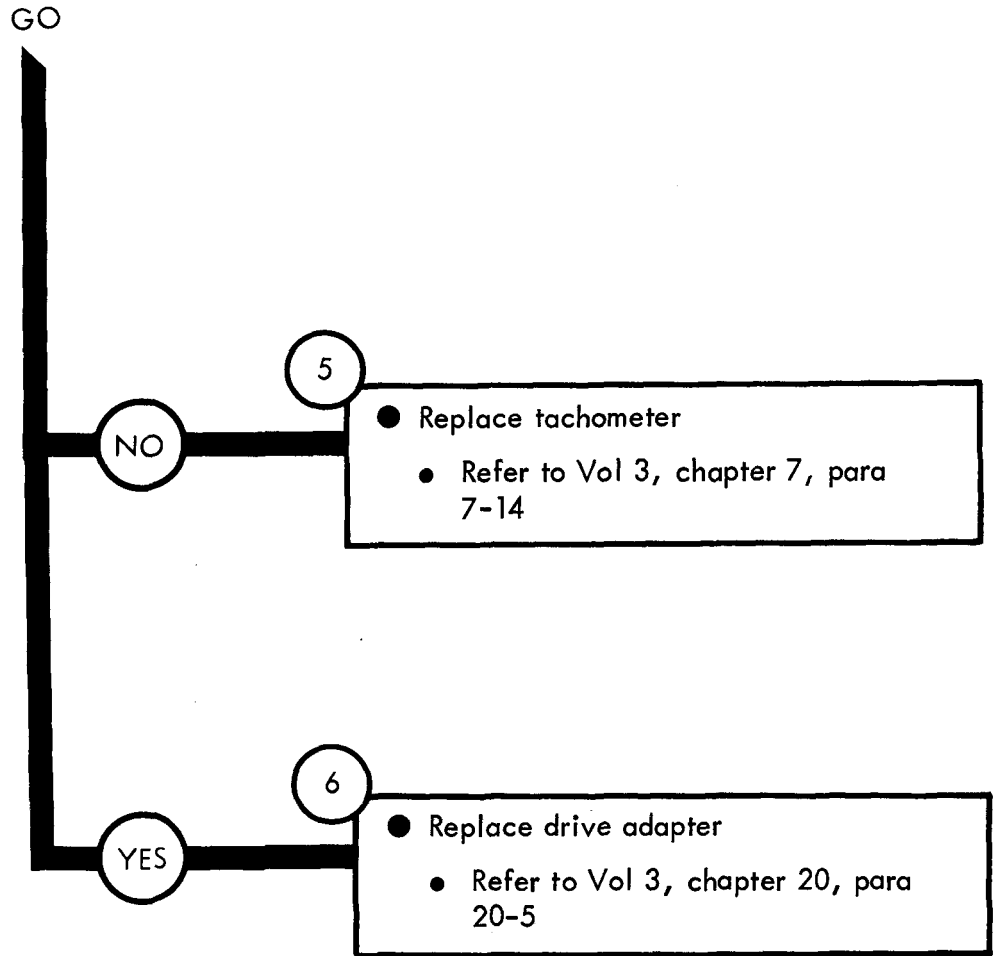

Figure 87-3 (Sheet 4 of 4)

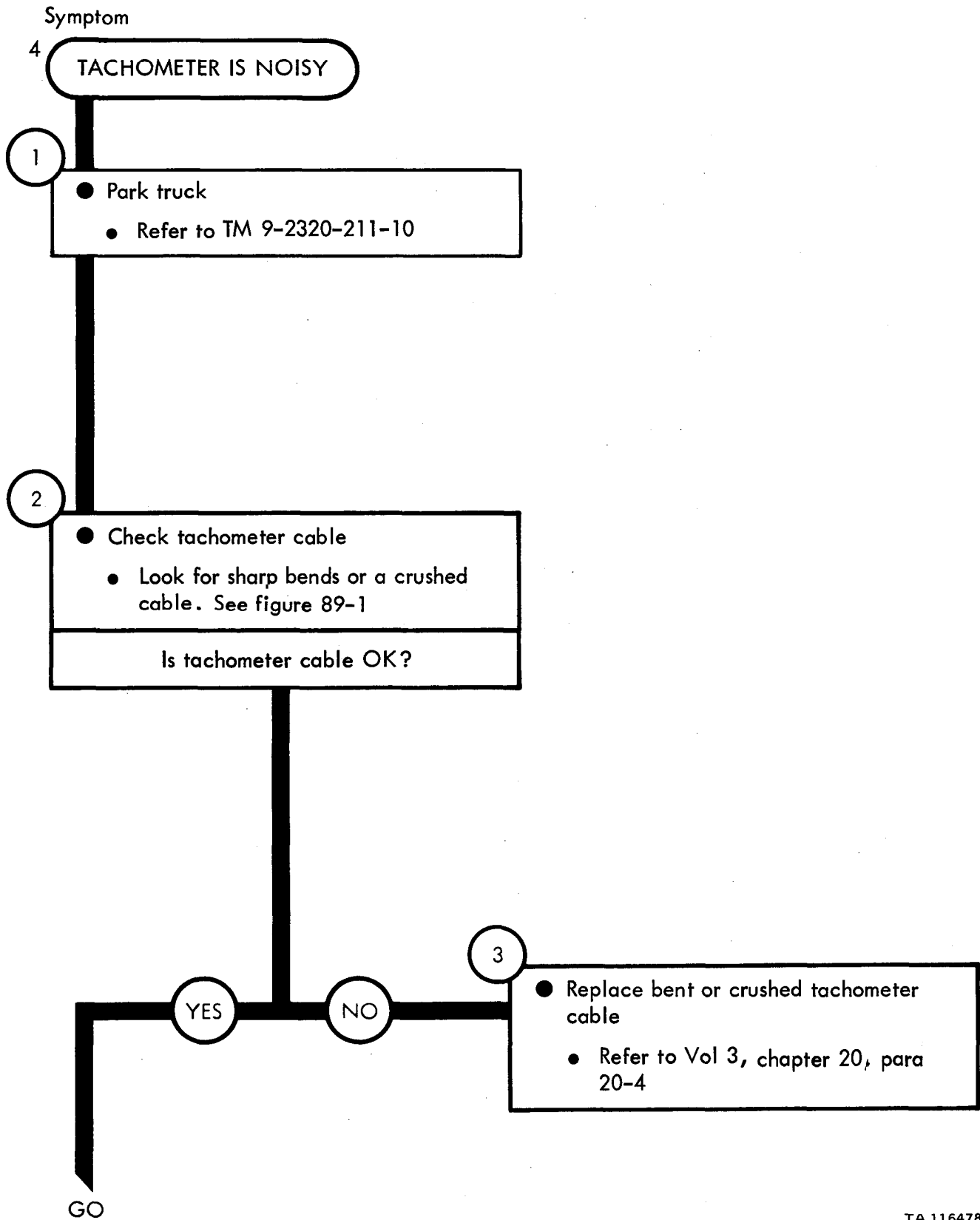

Figure 87-4 (Sheet 1 of 2)

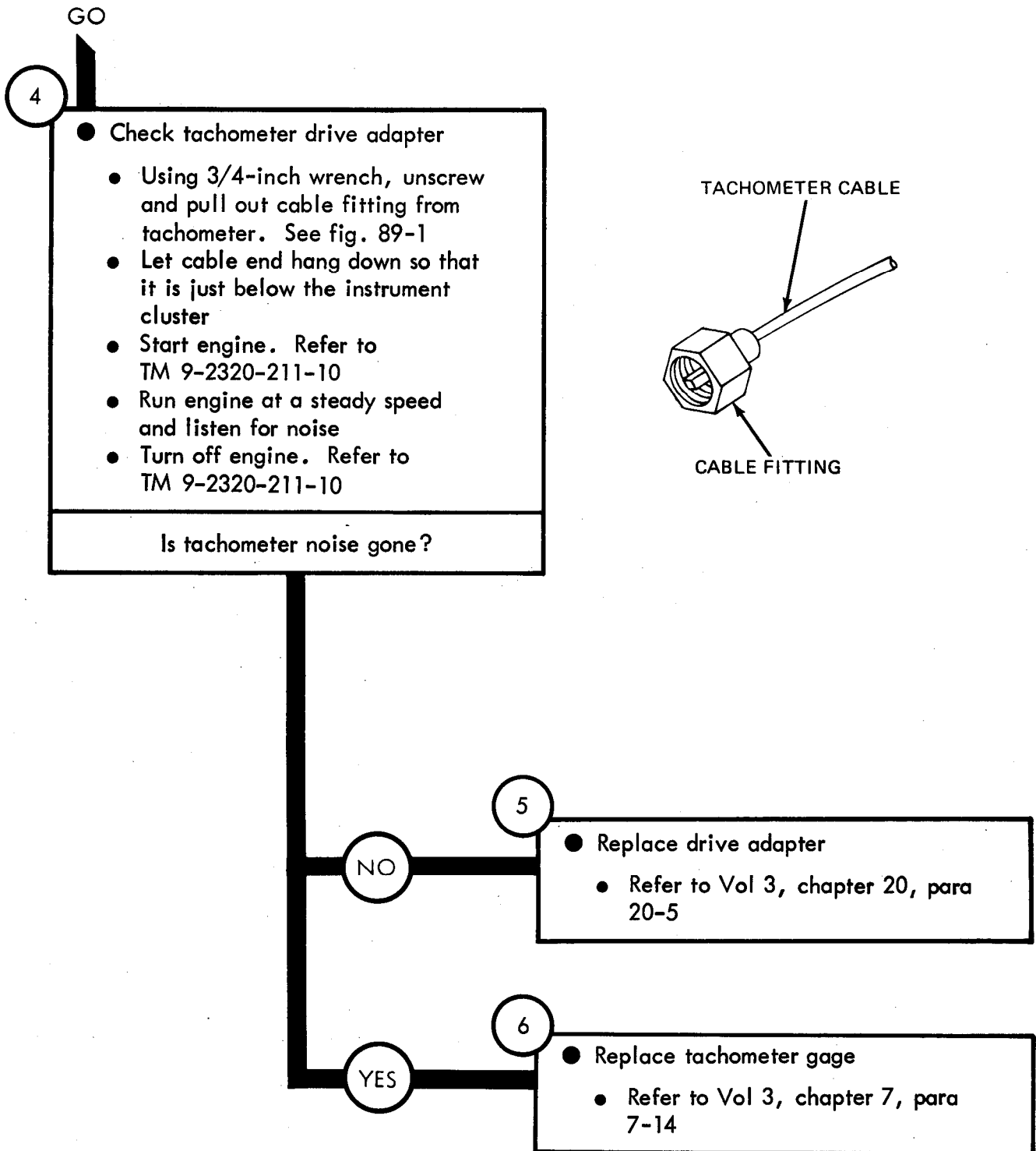

Figure 87-4 (Sheet 2 of 2)

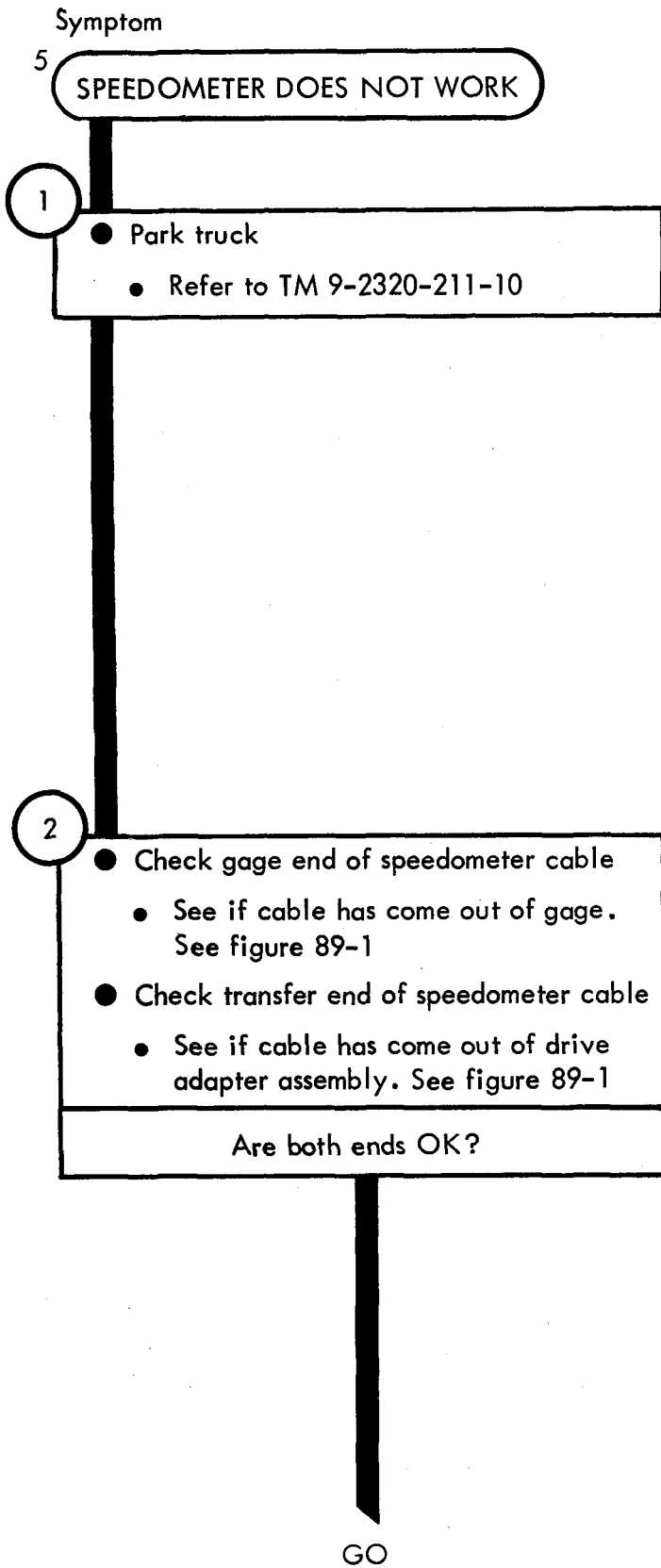

Figure 87-5 (Sheet 1 of 5)

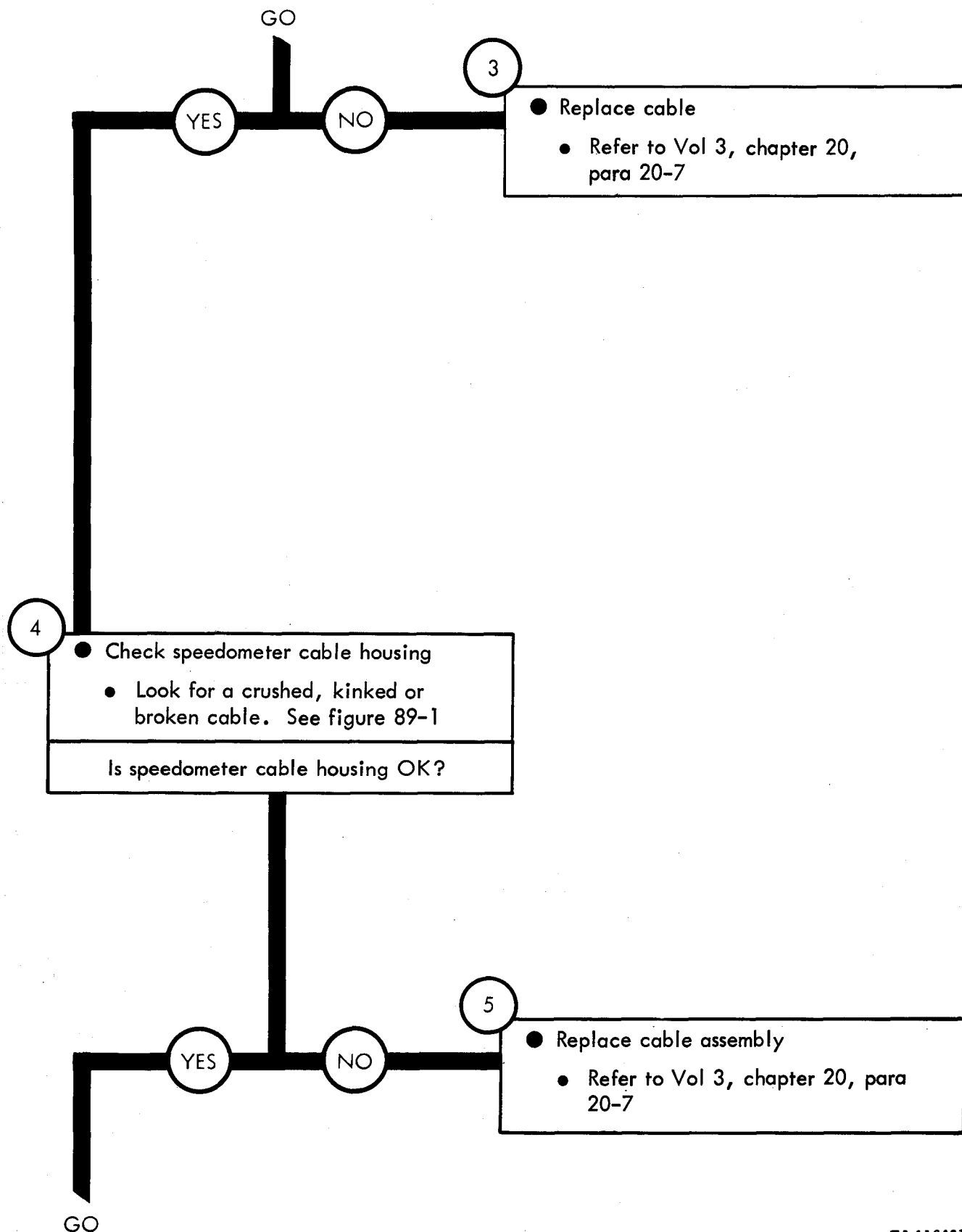

Figure 87-5 (Sheet 2 of 5)

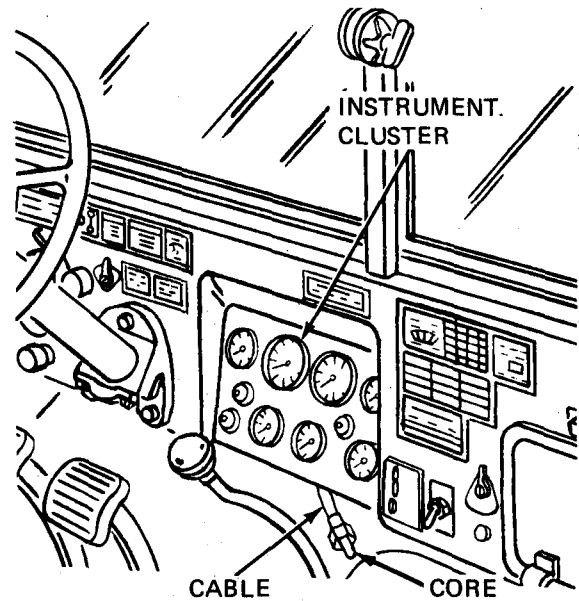
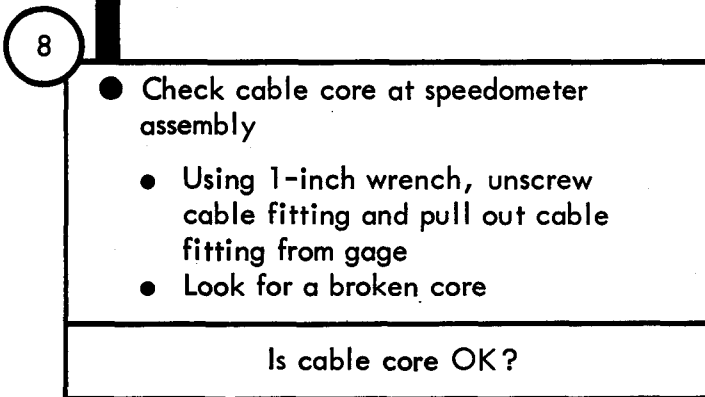
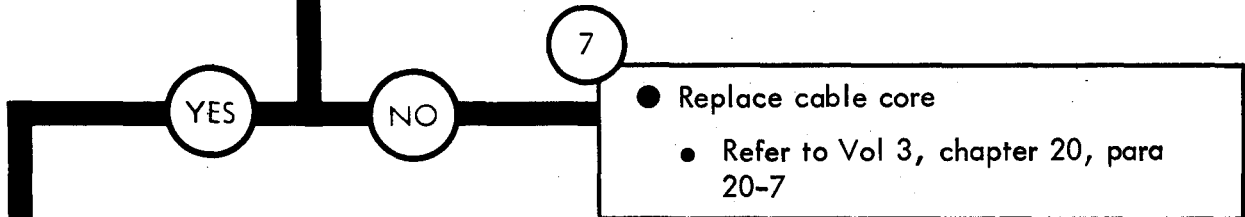
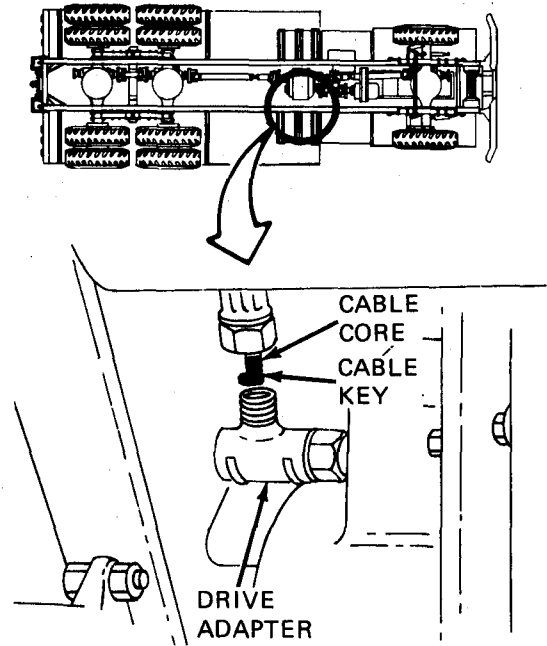
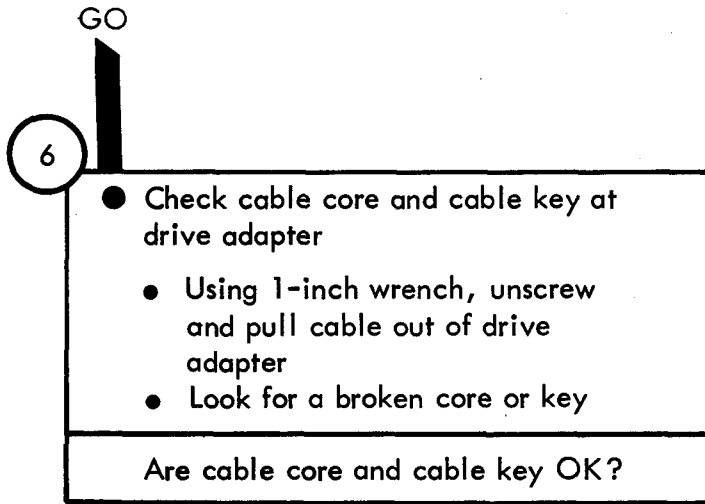
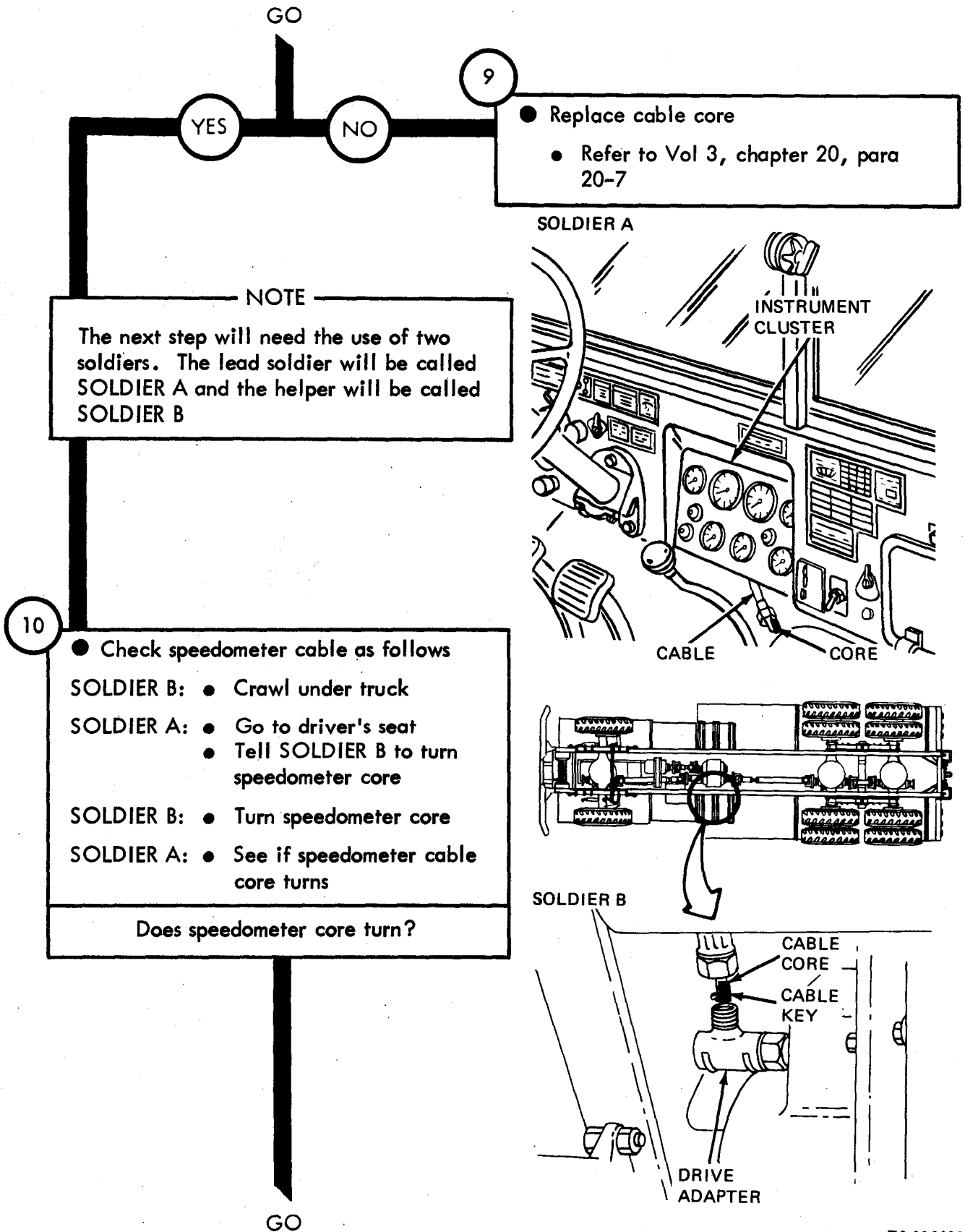

Figure 87-5 (Sheet 3 of 5)

TA 116482



9

- Replace cable core
- Refer to Vol 3, chapter 20, para 20-7

NOTE

The next step will need the use of two soldiers. The lead soldier will be called SOLDIER A and the helper will be called SOLDIER B

10

- Check speedometer cable as follows

SOLDIER B: ● Crawl under truck

SOLDIER A: ● Go to driver's seat

 ● Tell SOLDIER B to turn speedometer core

SOLDIER B: ● Turn speedometer core

SOLDIER A: ● See if speedometer cable core turns

Does speedometer core turn?

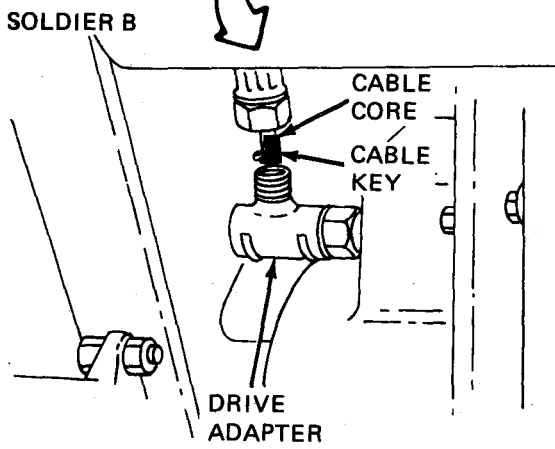
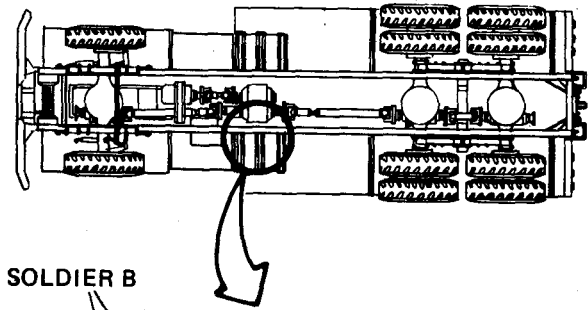
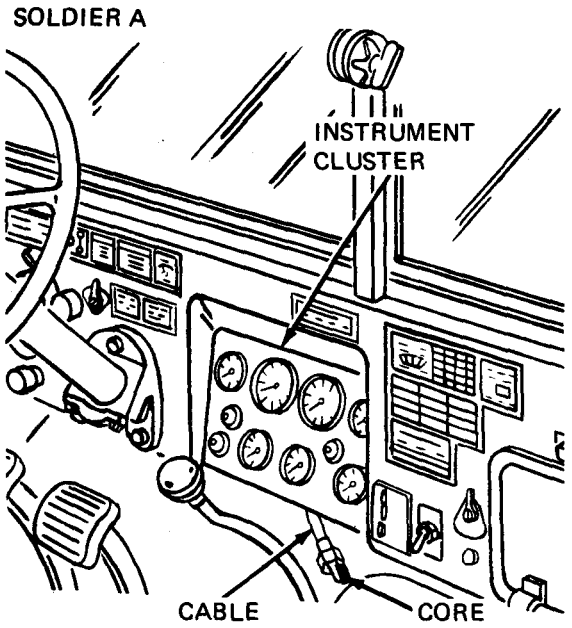
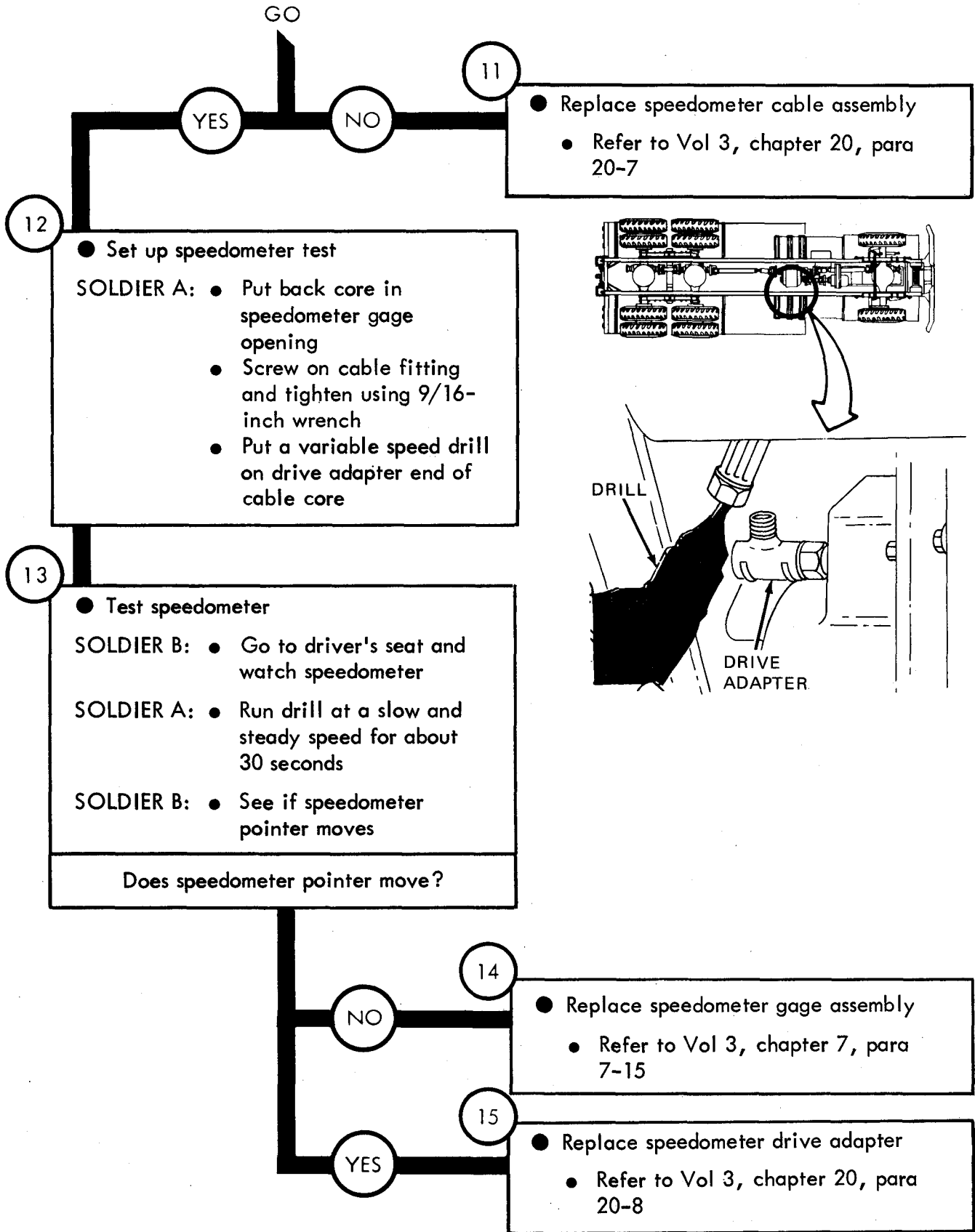

Figure 87-5 (Sheet 4 of 5)



TA 116484

Figure 87-5 (Sheet 5 of 5)

Symptom

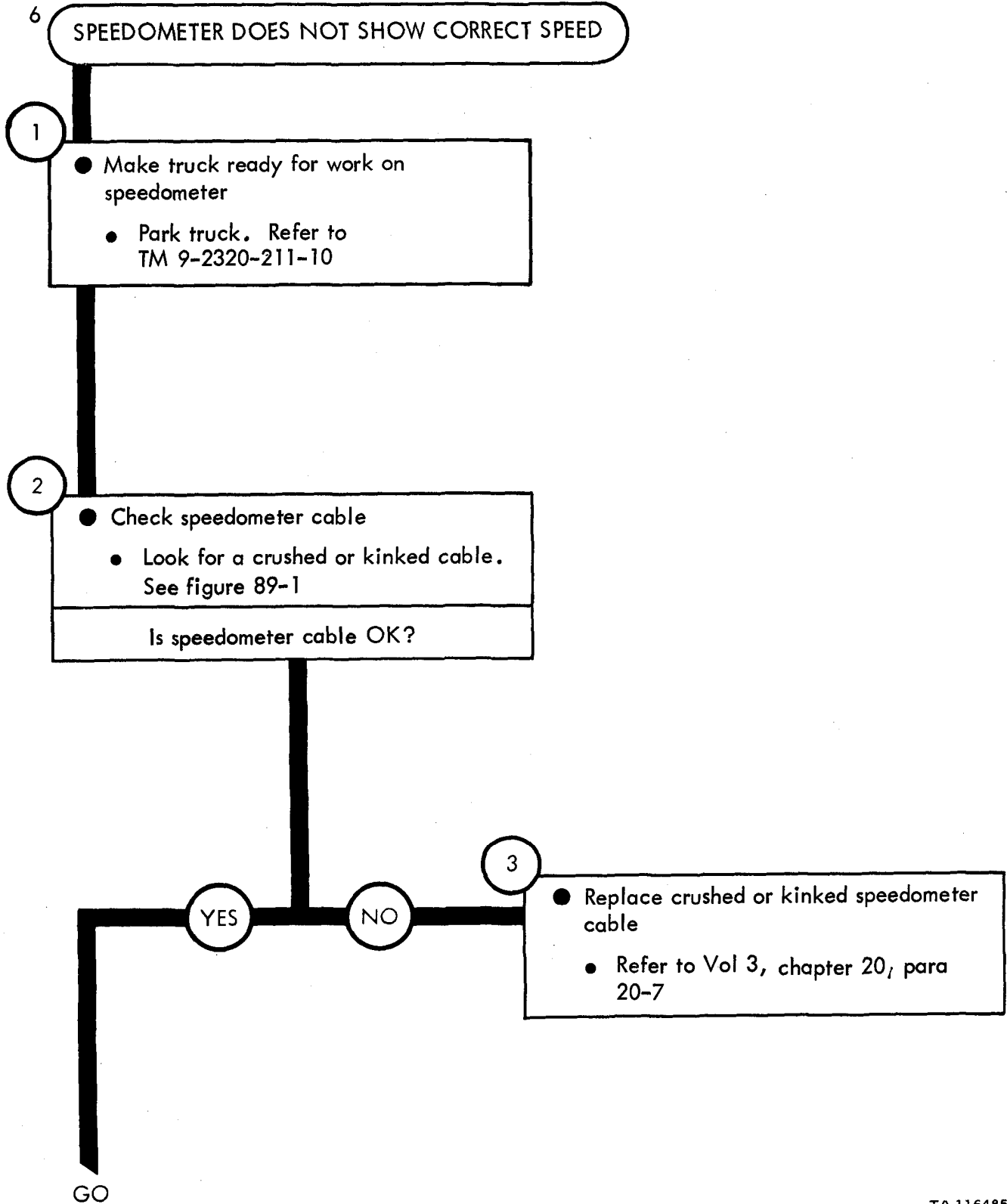

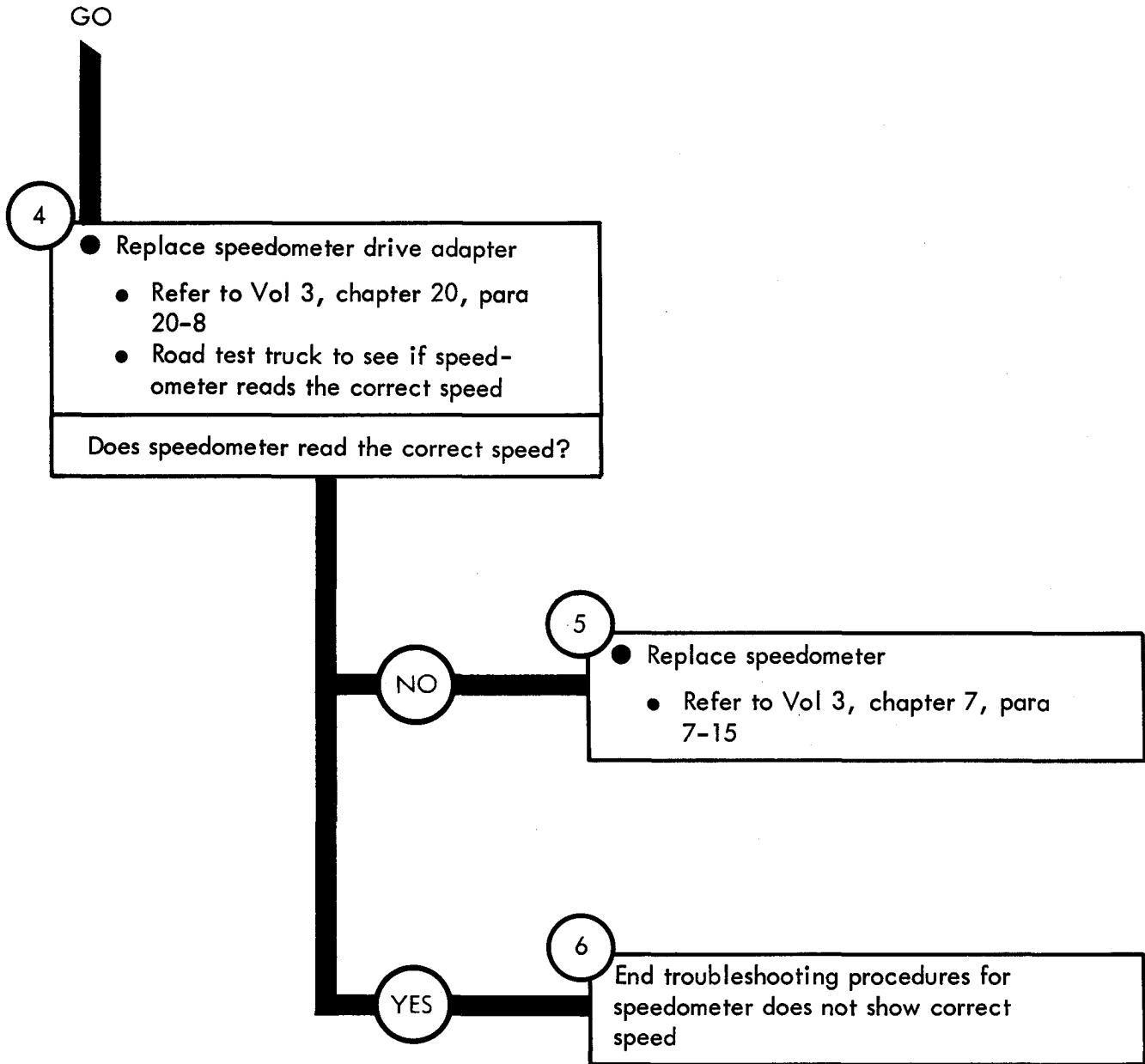

Figure 87-6 (Sheet 2 of 2)

SPEEDOMETER TROUBLESHOOTING

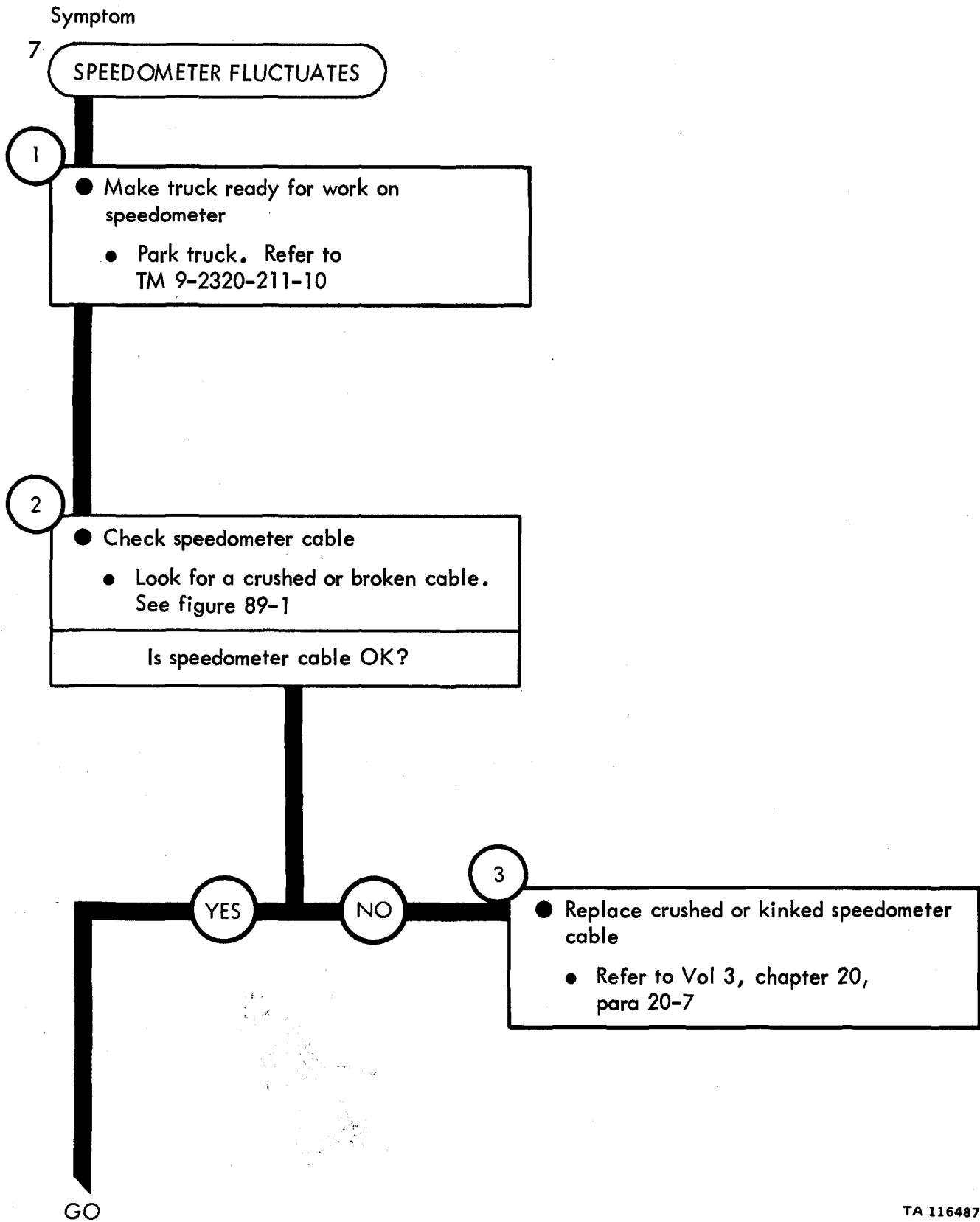

Figure 87-7 (Sheet 1 of 3)

TA 116487

GO

4

- Set up speedometer test
 - Using 1-inch wrench unscrew and take off speedometer cable from drive adapter assembly
 - Put a variable speed drill on cable core end

NOTE

This next step will need the use of two soldiers. The lead soldier will be called Soldier A and the helper will be called Soldier B

5

- Test speedometer
 - SOLDIER B: ● Go to driver's seat and watch speedometer
 - SOLDIER A: ● Run drill at a slow and steady speed for about 30 seconds
 - SOLDIER B: ● See if speedometer pointer moves unevenly

Does speedometer run smoothly?

GO

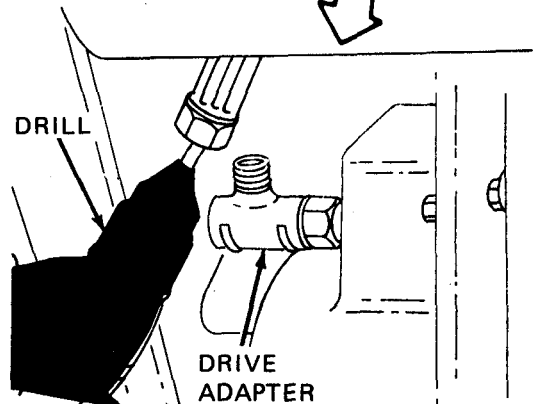
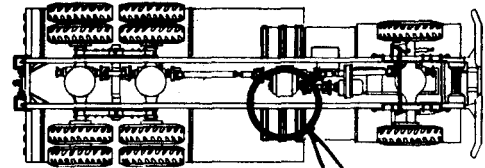
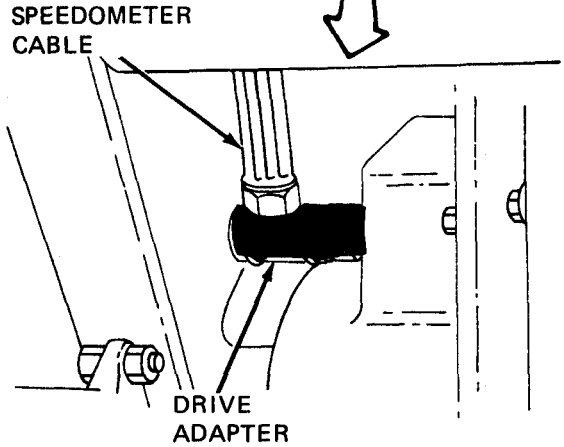
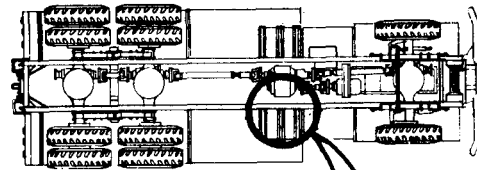

TA 116488

Figure 87-7 (Sheet 2 of 3)

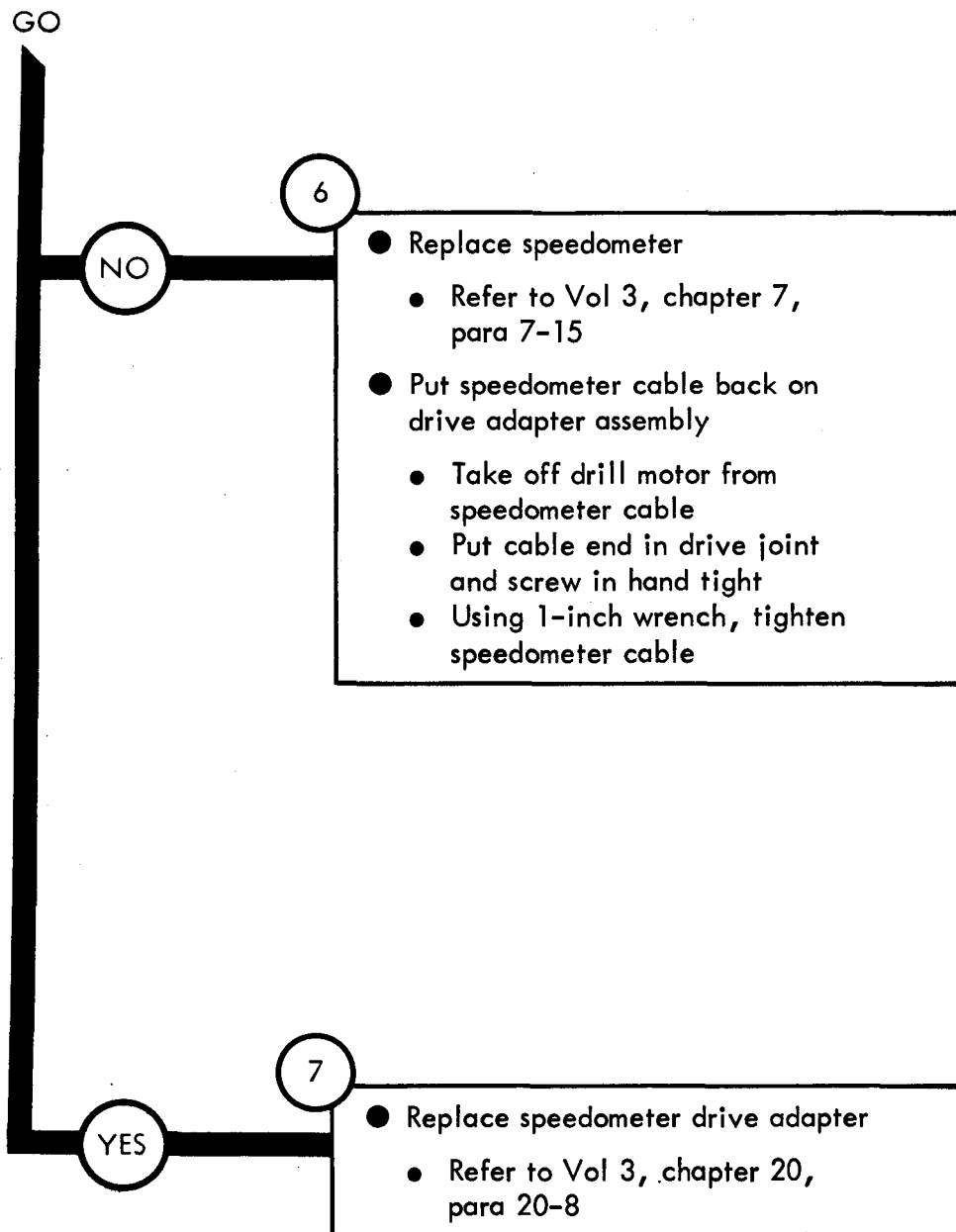

Figure 87-7 (Sheet 3 of 3)

Symptom

8

TACHOGRAPH SPEEDOMETER DOES NOT WORK, TACHOMETER WORKS

1

- Make truck ready for work on tachograph speedometer
 - Park truck. Refer to TM 9-2320-211-10
 - Chock wheels

2

- Check speedometer cable
 - Look for a crushed or kinked cable. See fig. 89-1
 - Look for a broken cable

Is speedometer cable OK?

YES

NO

3

- Replace crushed, kinked, or broken speedometer cable
 - Refer to Vol 3, chapter 20, para 20-7

GO

Figure 87-8 (Sheet 1 of 4)

GO

4

- Set up tachograph speedometer test
 - Using 3/4-inch wrench unscrew and take off speedometer cable from drive adapter assembly

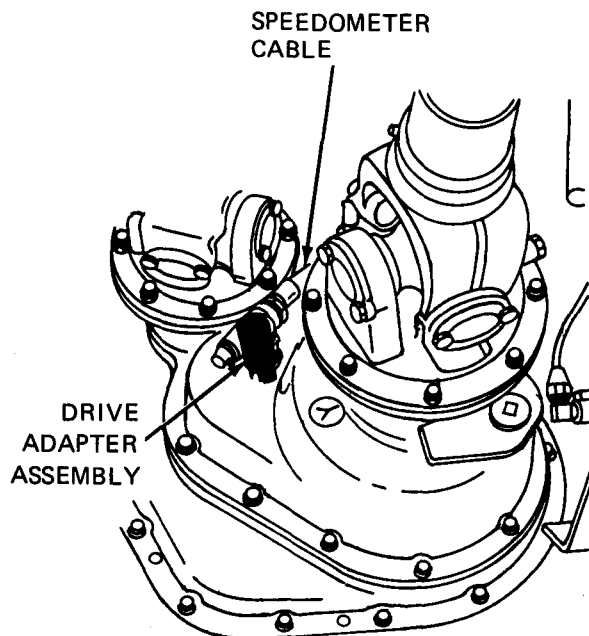

NOTE

This next step will need the use of two soldiers. The lead soldier will be called Soldier A, and the helper will be called Soldier B

5

- Test tachograph speedometer
 - Soldier B: ● Go to drivers seat and watch tachograph speedometer
 - Soldier A: ● Turn speedometer cable core to the right as quickly as possible
 - Soldier B: ● See if speedometer pointer moves

Does tachograph speedometer show a reading?

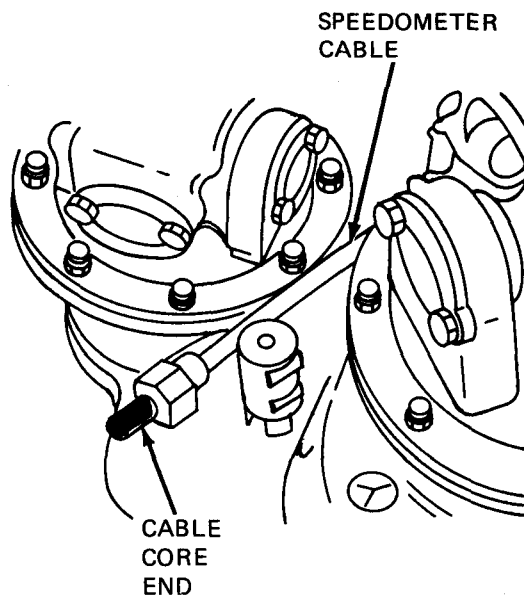

GO

Figure 87-8 (Sheet 2 of 4)

TA 116491

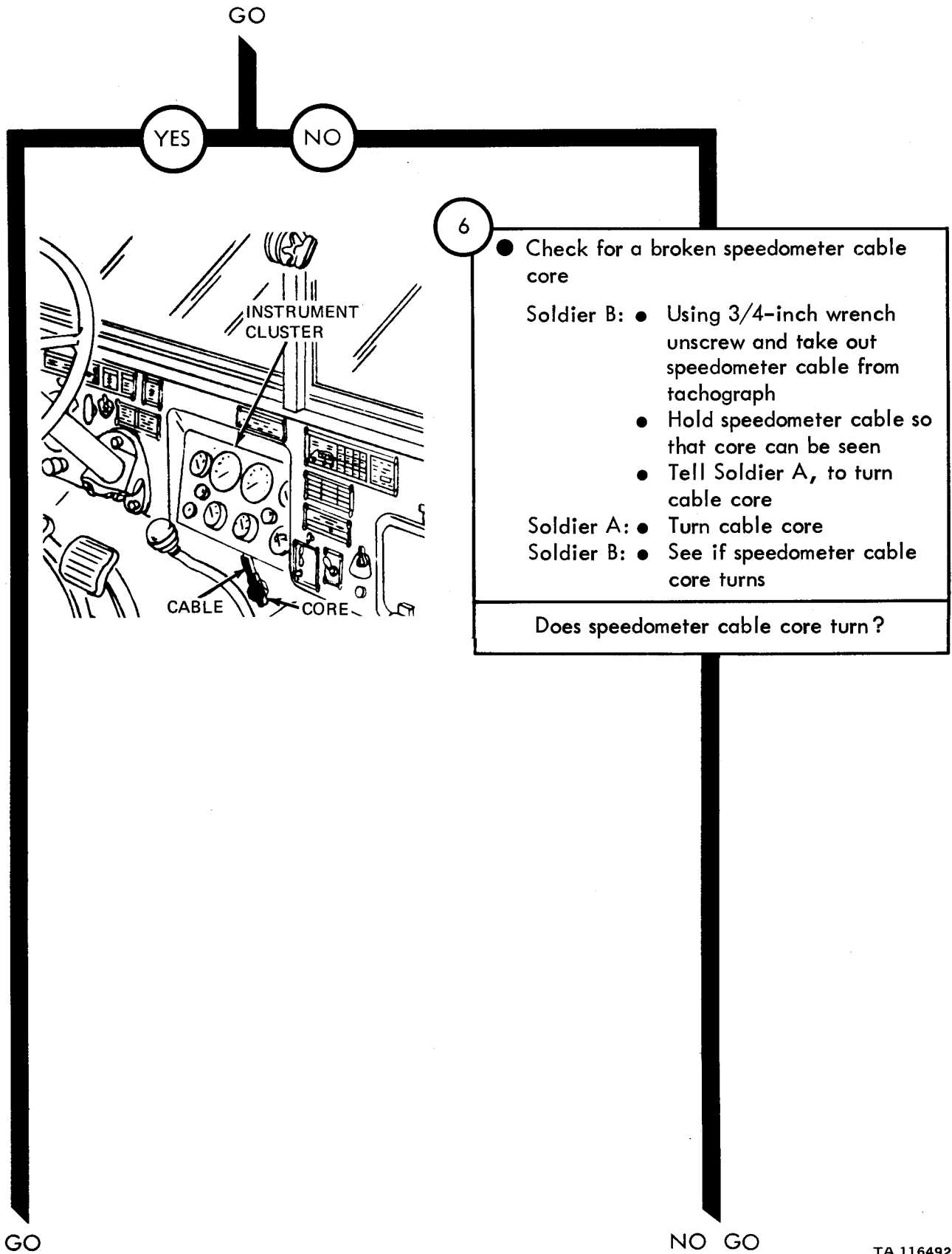

Figure 87-8 (Sheet 3 of 4)

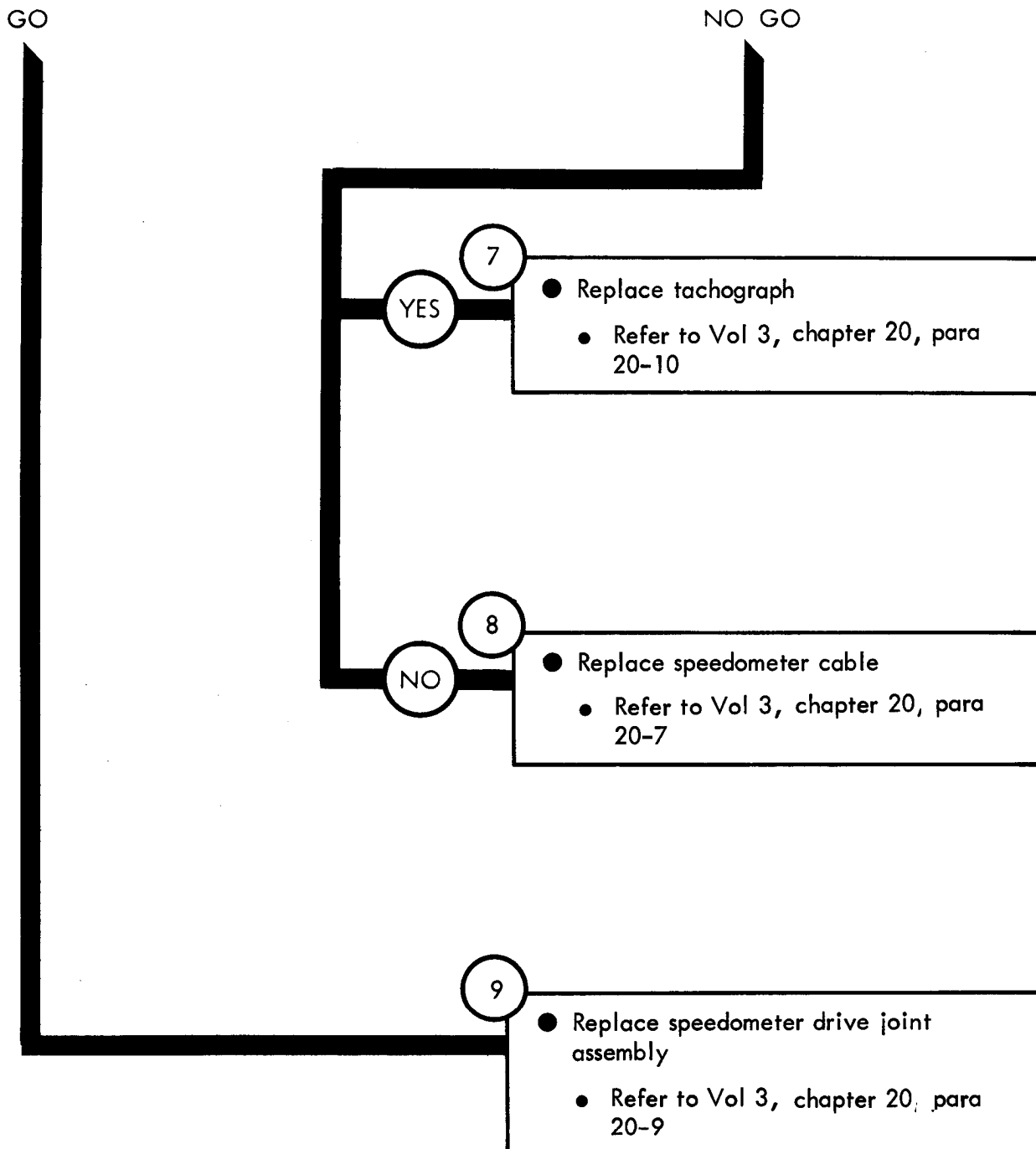

Figure 87-8 (Sheet 4 of 4)

Symptom

9 TACHOGRAPH SPEEDOMETER DOES NOT SHOW CORRECT SPEED,
TACHOMETER WORKS OK

1

- Make truck ready for work on tachograph speedometer
 - Park truck. Refer to TM 9-2320-211-10
 - Chock wheels

2

- Check speedometer cable
 - Look for a crushed, or kinked cable. See fig. 89-1

Is speedometer cable OK?

YES

NO

3

- Replace crushed, or kinked speedometer cable
 - Refer to Vol 3, chapter 20, para 20-7

GO

Figure 87-9 (Sheet 1 of 2)

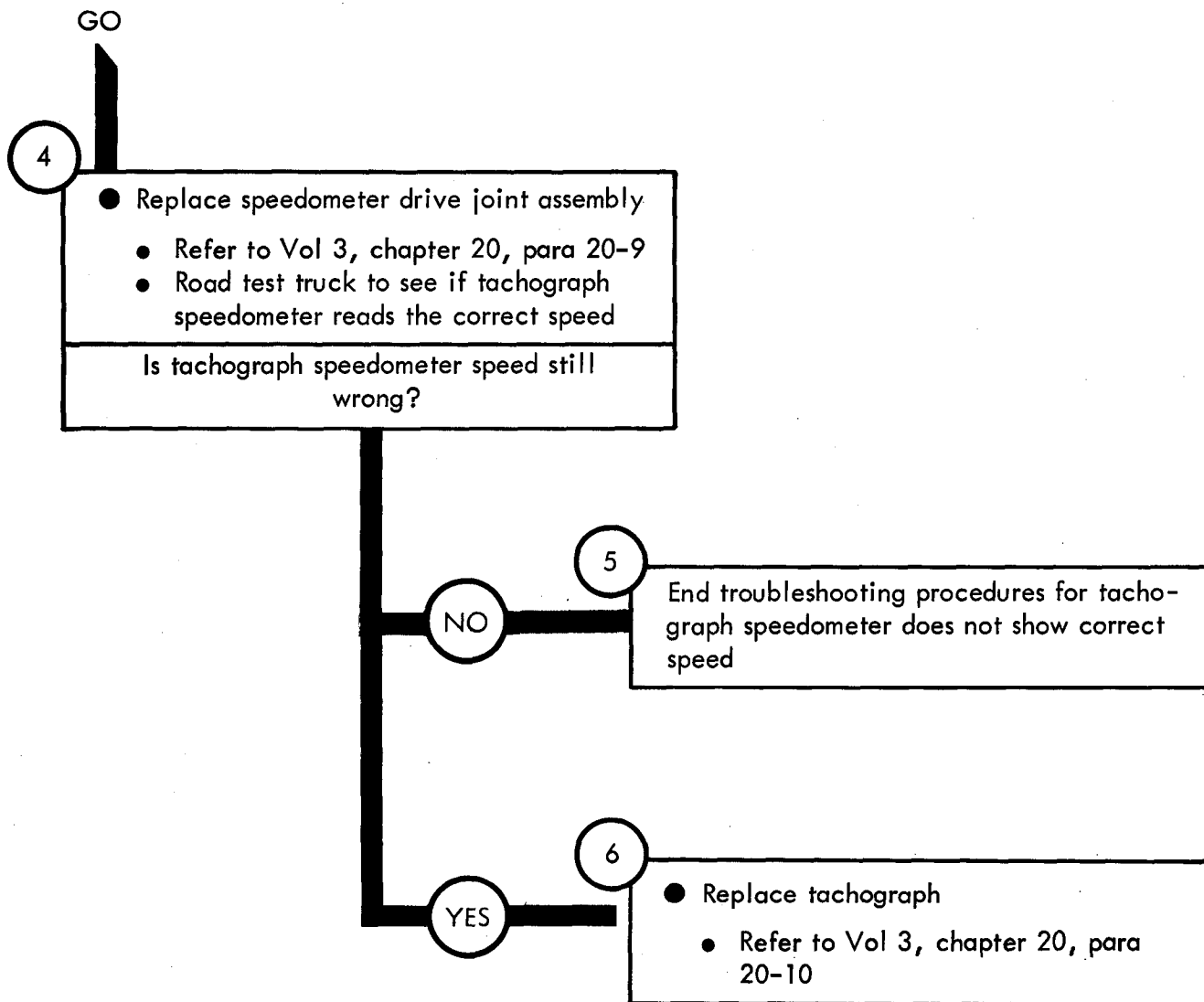

Figure 87-9 (Sheet 2 of 2)

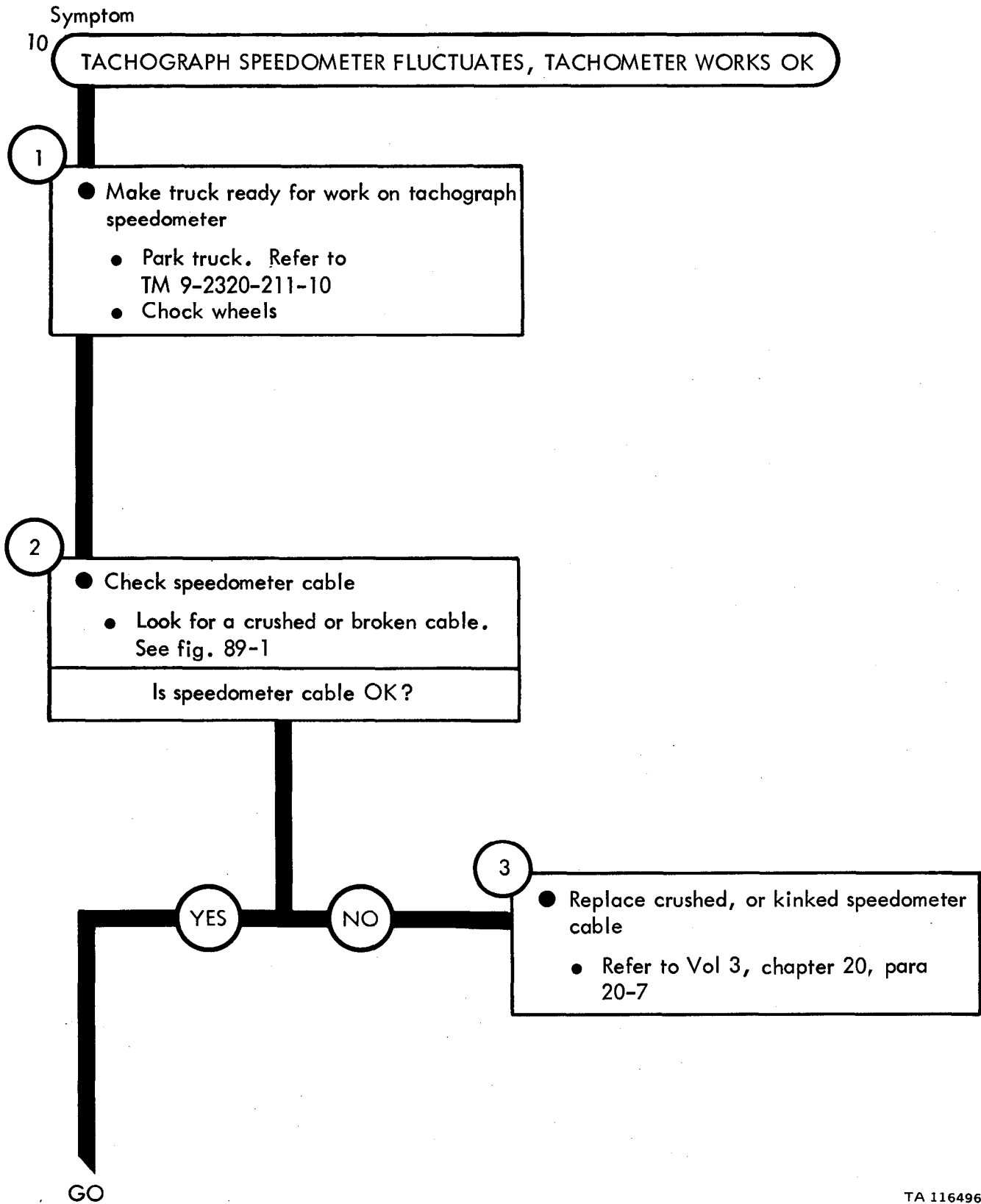
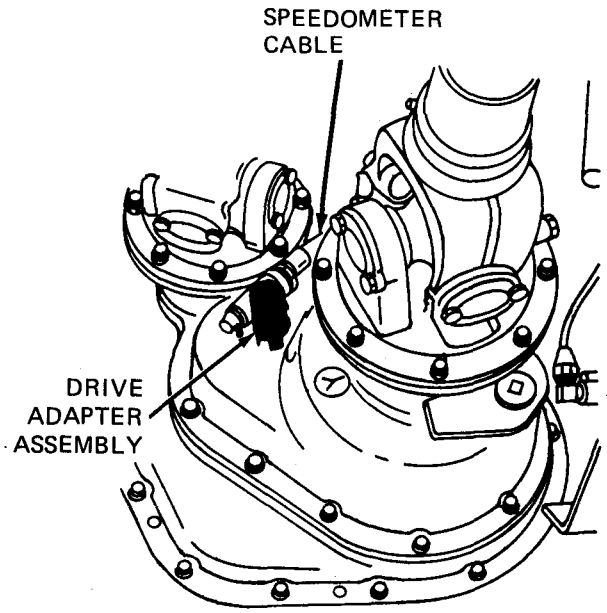

Figure 87-10 (Sheet 1 of 3)

GO

4

- Set up tachograph speedometer test
- Using 1-inch wrench unscrew and take off speedometer cable from drive adapter assembly



5

- Test tachograph speedometer
- Turn cable core end by hand

Does cable core end turn smoothly?

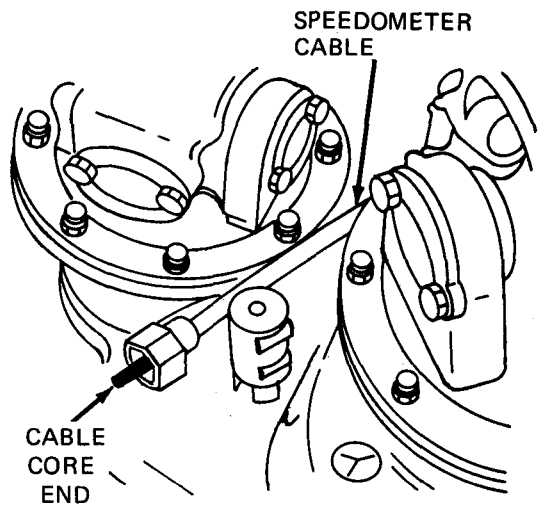

GO

Figure 87-10 (Sheet 2 of 3)

TA 116497

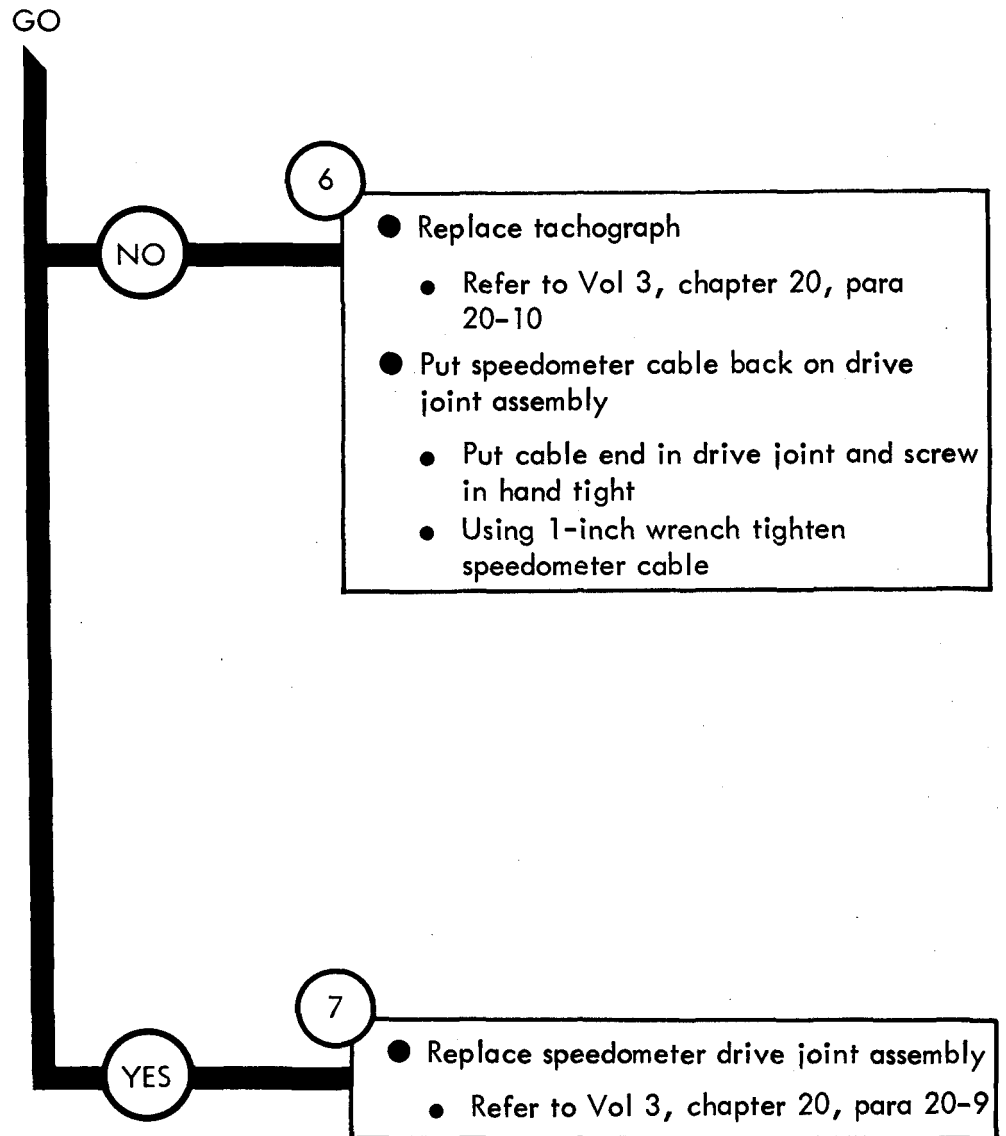
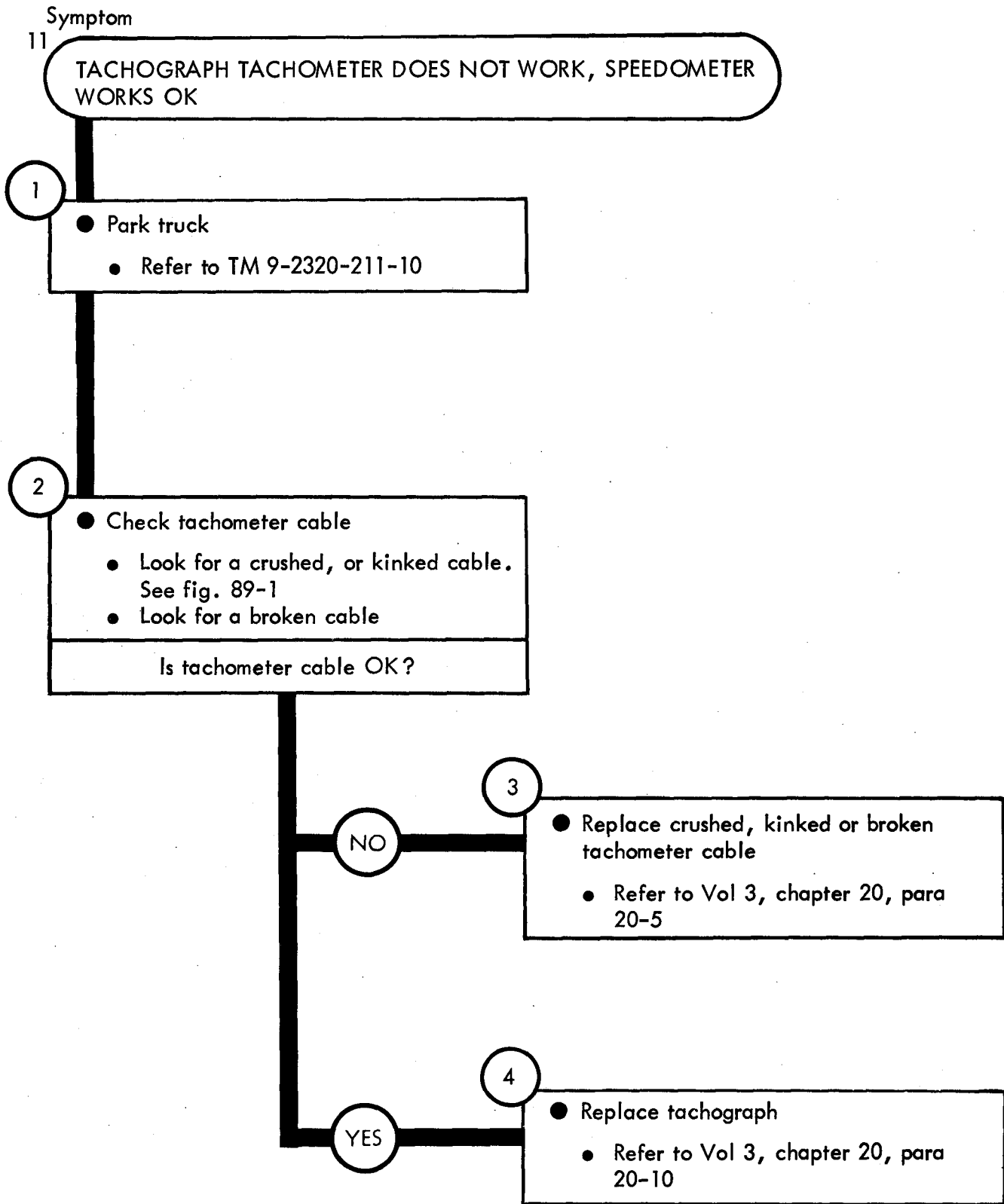

Figure 87-10 (Sheet 3 of 3)



TA 116499

Figure 87-11 (Sheet 1 of 2)

Symptom

12

TACHOGRAPH TACHOMETER FLUCTUATES, OR DOES NOT SHOW CORRECT READING, SPEEDOMETER WORKS OK

- Park truck
 - Refer to TM 9-2320-211-10

2

- Check tachometer cable
 - Look for a crushed, or kinked cable. See fig. 89-1

Is tachometer cable OK?

NO

3

- Replace crushed, or kinked, tachometer cable
 - Refer to Vol 3, chapter 20, para 20-5

YES

4

- Replace tachograph
 - Refer to Vol 3, chapter 20, para 20-10

TA 116500

Figure 87-12

CHAPTER 88

NONELECTRICAL GAGES TROUBLESHOOTING SUMMARY

88-1. GENERAL. This chapter gives a summary of troubleshooting procedures given in chapter 87, for the Nonelectrical Gages System.

88-2. PROCEDURES. The summary in this chapter covers all fault symptoms found in the detailed troubleshooting procedures in Part 1. Chapter 7 outlines a sample troubleshooting procedure. The summary procedures are based on the "what-to-do" portions of the detailed procedures and do not include the "How-to-do-it" instructions. Warnings, cautions, and notes are given where needed.

NONELECTRICAL GAGES TROUBLESHOOTING SUMMARY

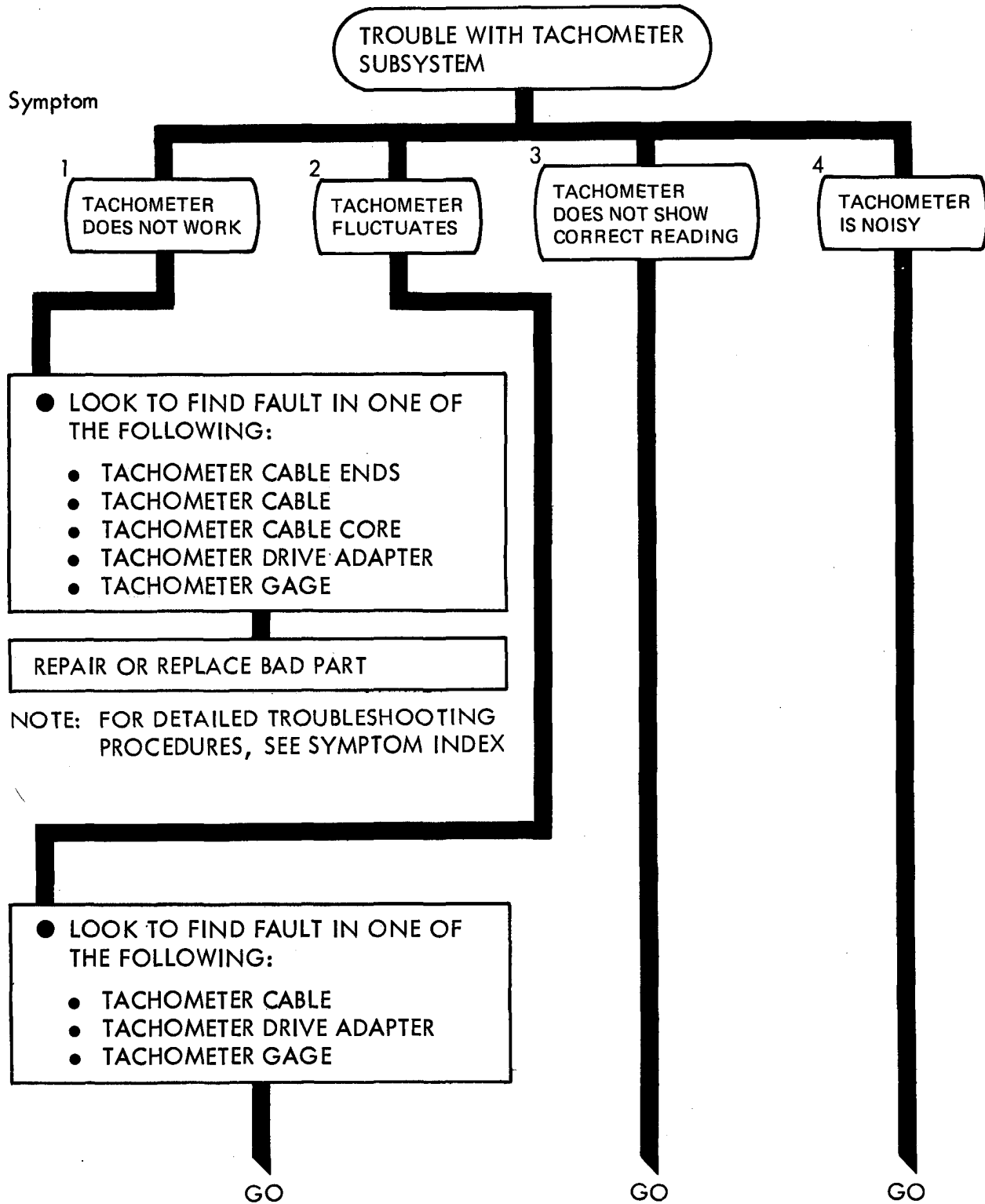

Figure 88-1 (Sheet 1 of 2)

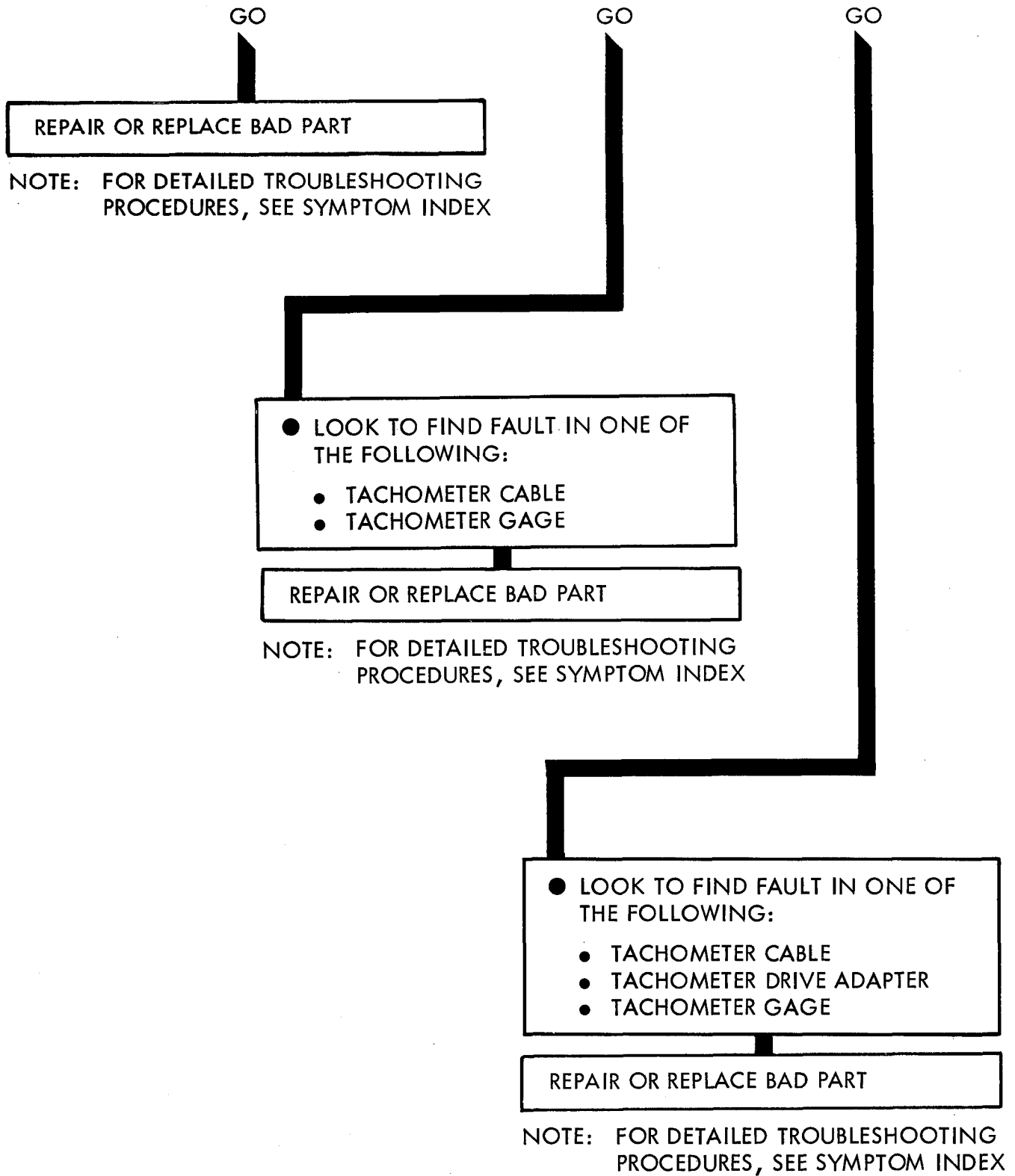

Figure 88-1 (Sheet 2 of 2)

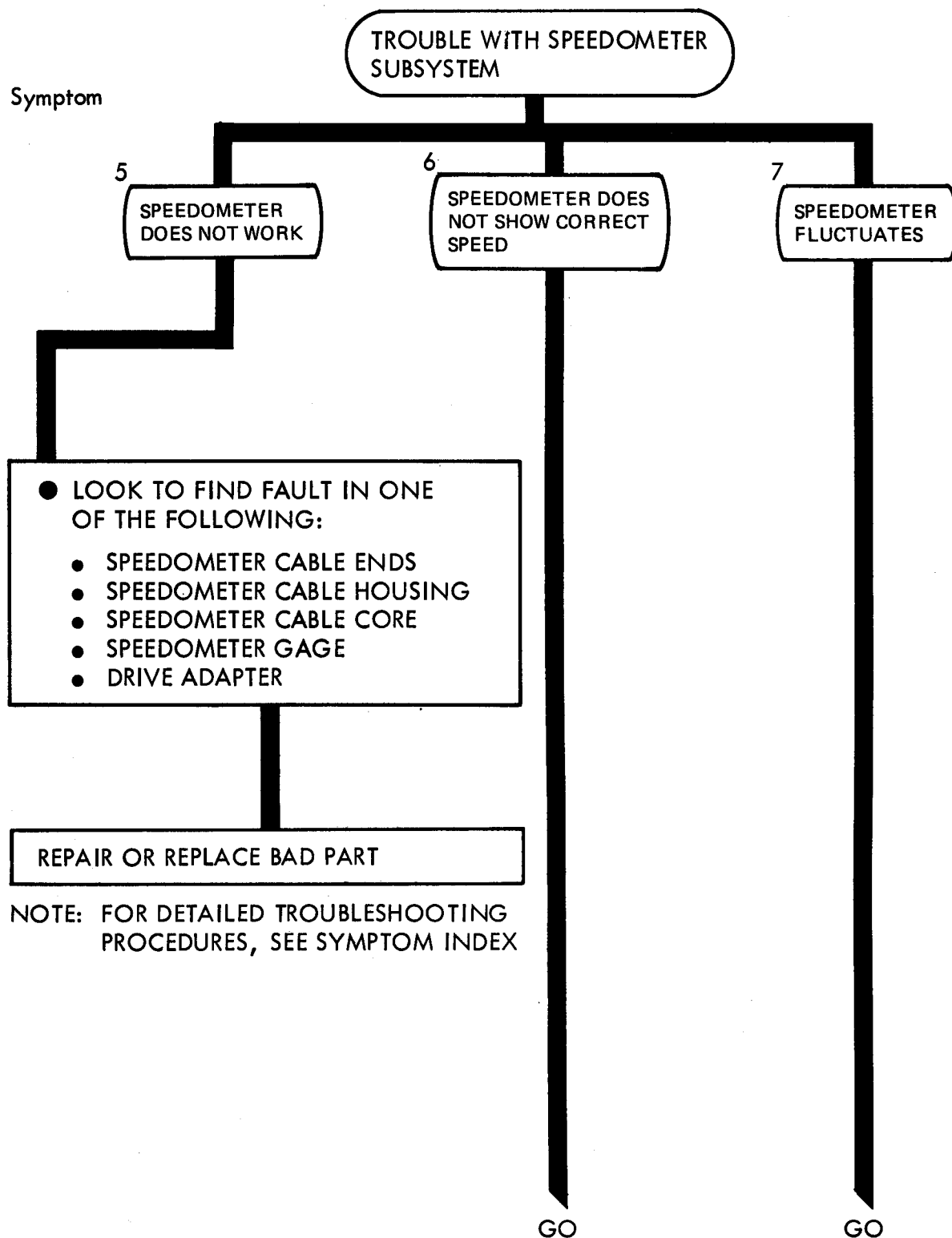

Figure 88-2 (Sheet 1 of 2)

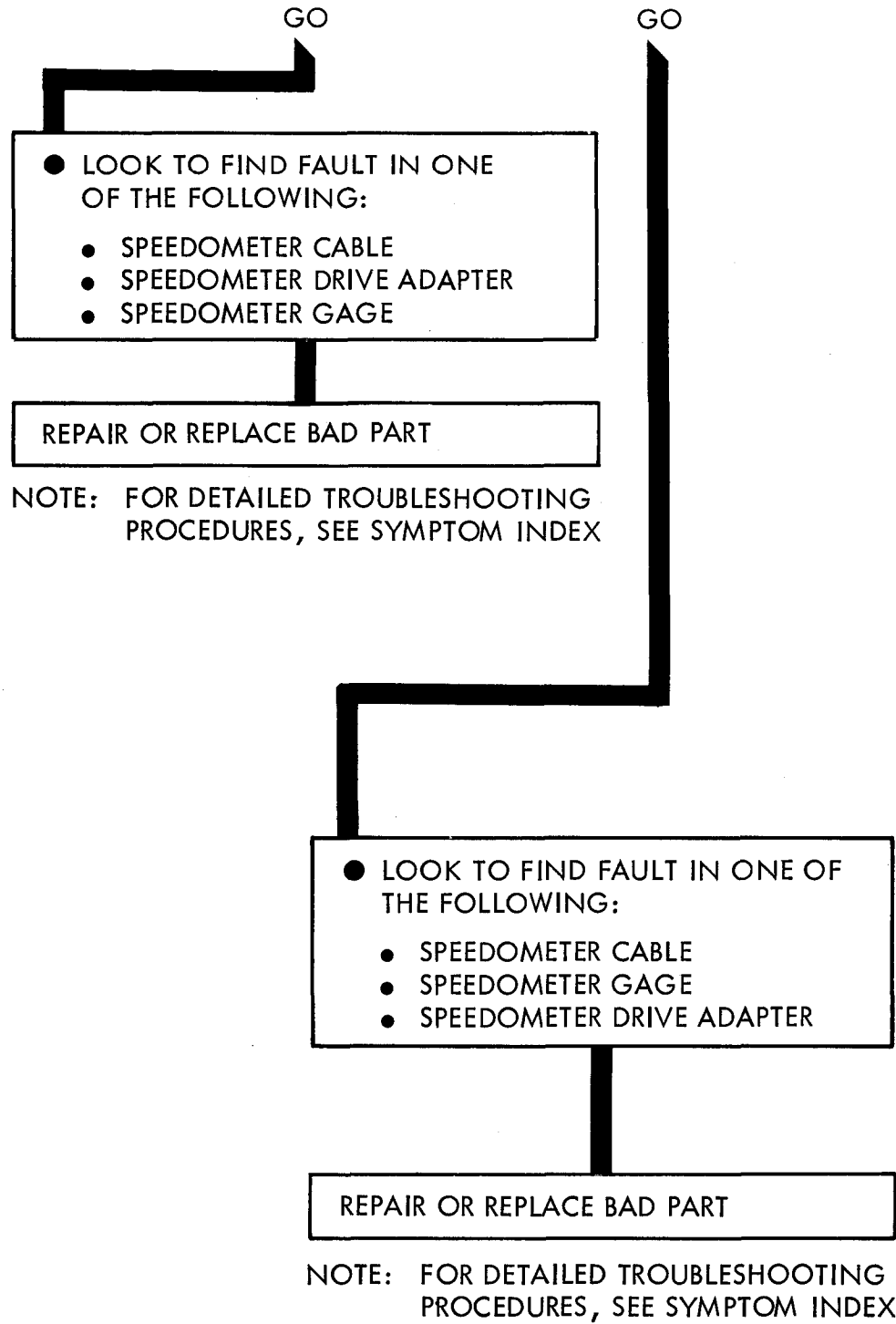

Figure 88-2 (Sheet 2 of 2)

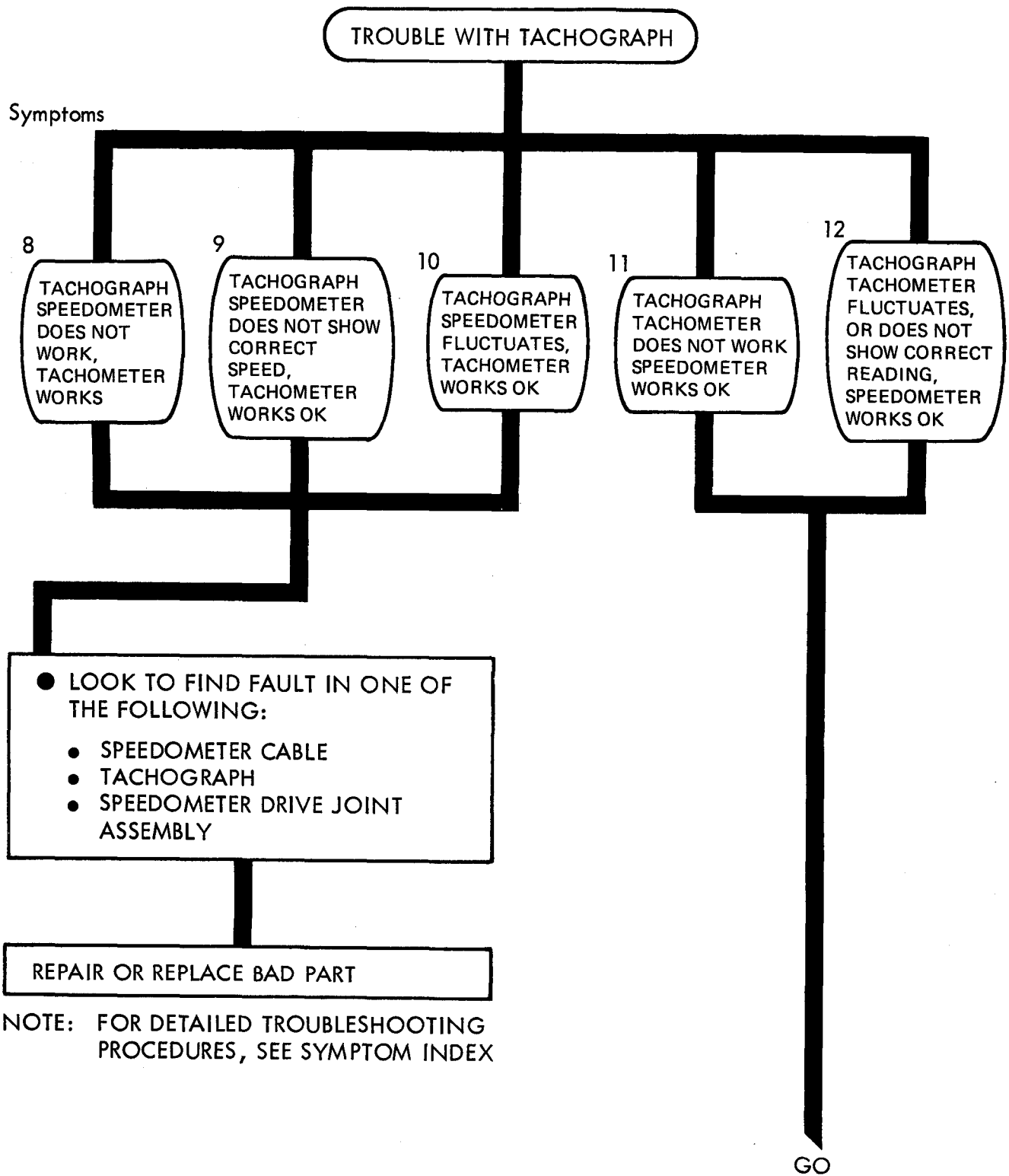
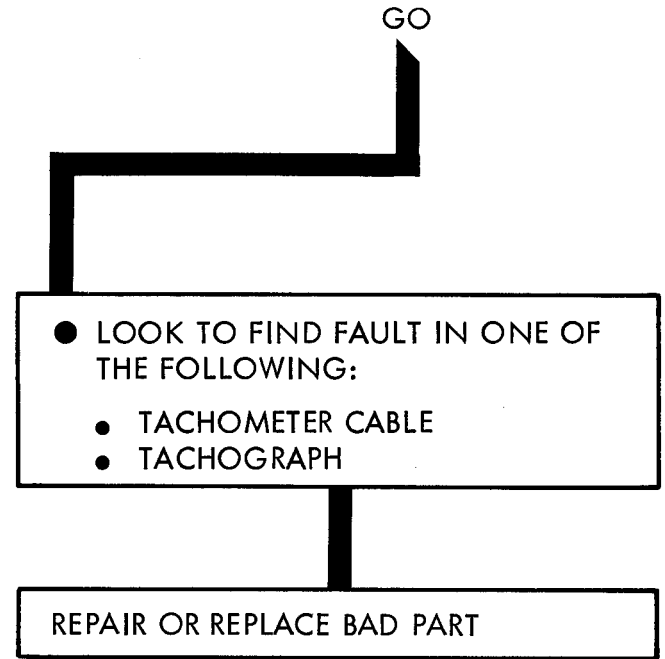

Figure 88-3 (Sheet 1 of 2)



NOTE: FOR DETAILED TROUBLESHOOTING PROCEDURES, SEE SYMPTOM INDEX

CHAPTER 89

NON ELECTRICAL GAGES SUPPORT DIAGRAMS

89-1. GENERAL. This chapter gives the diagrams you need when doing troubleshooting procedures in chapter 87 (figure 89-1). Table 3-1 is a complete listing of all support diagrams used in this manual.

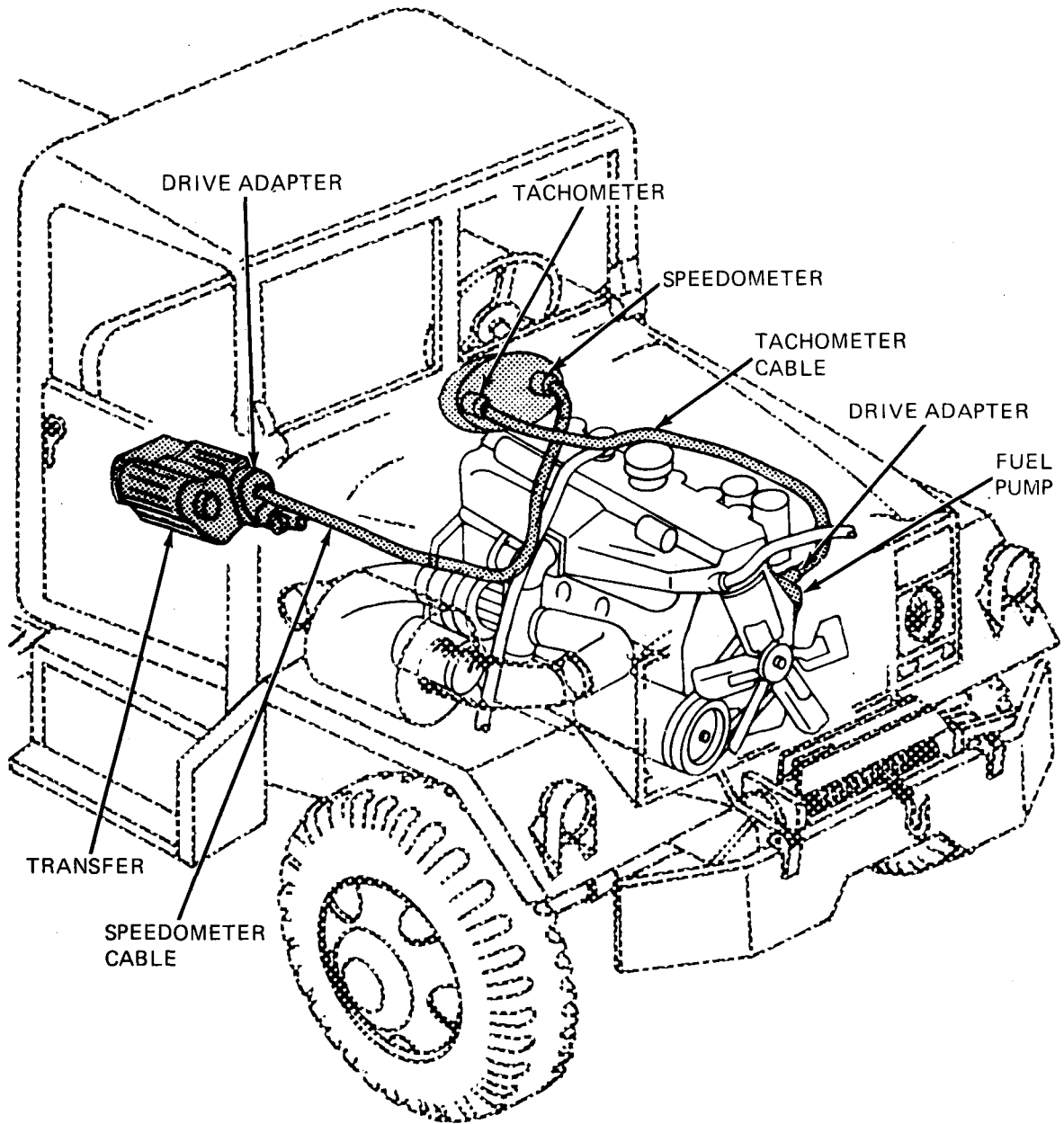

TA 116507

Figure 89-1. Non Electrical Gages Support Diagram

CHAPTER 90

NON ELECTRICAL GAGES CHECKOUT PROCEDURES

90-1. GENERAL. This chapter gives procedures for checking out the system after troubleshooting and repair have been done. Procedures are set up in flow chart form showing the checkout steps in order and referring to the fault symptom index when the system does not checkout.

NONELECTRICAL GAGES CHECKOUT

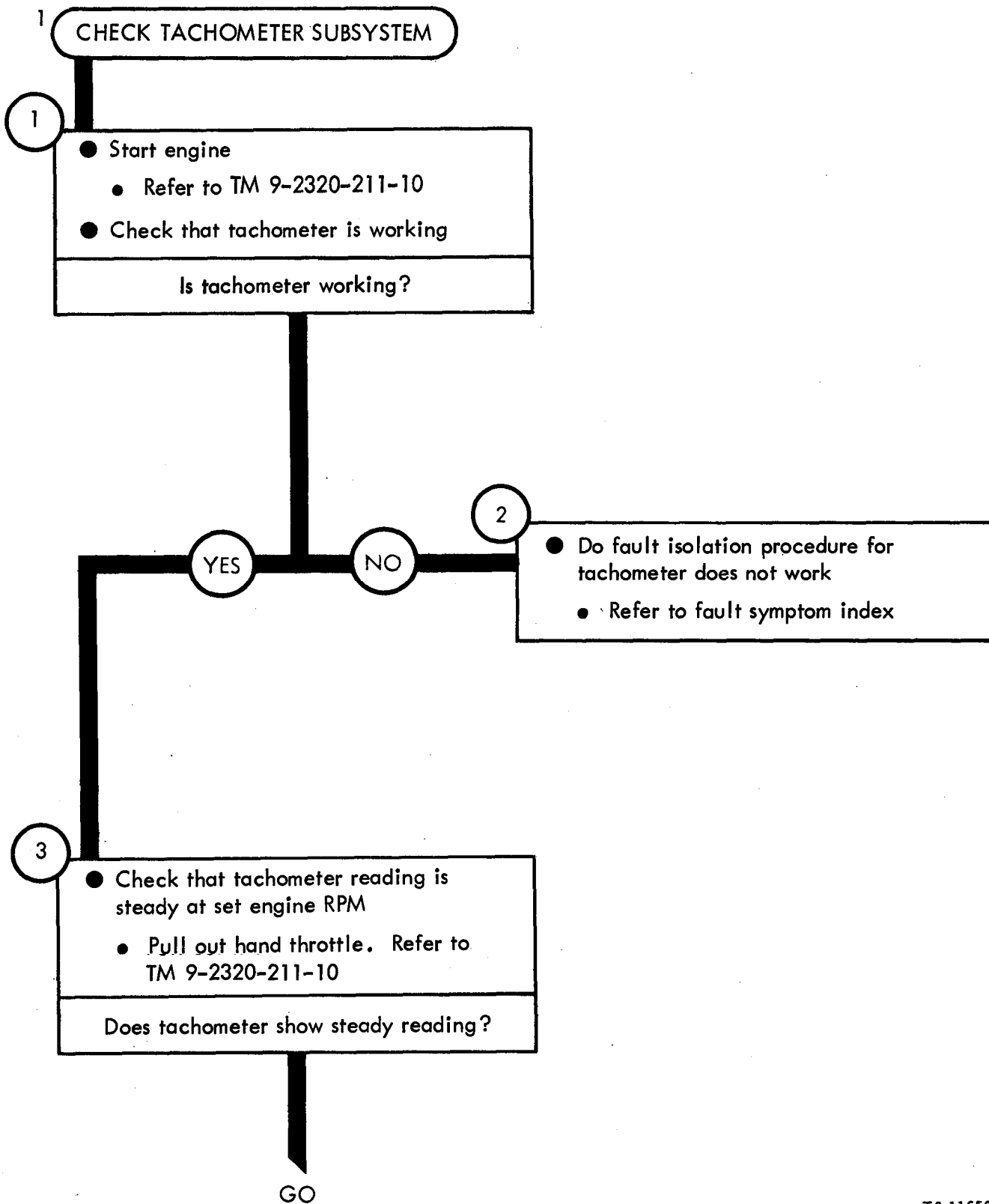

Figure 90-1 (Sheet 1 of 3)

TA 116508

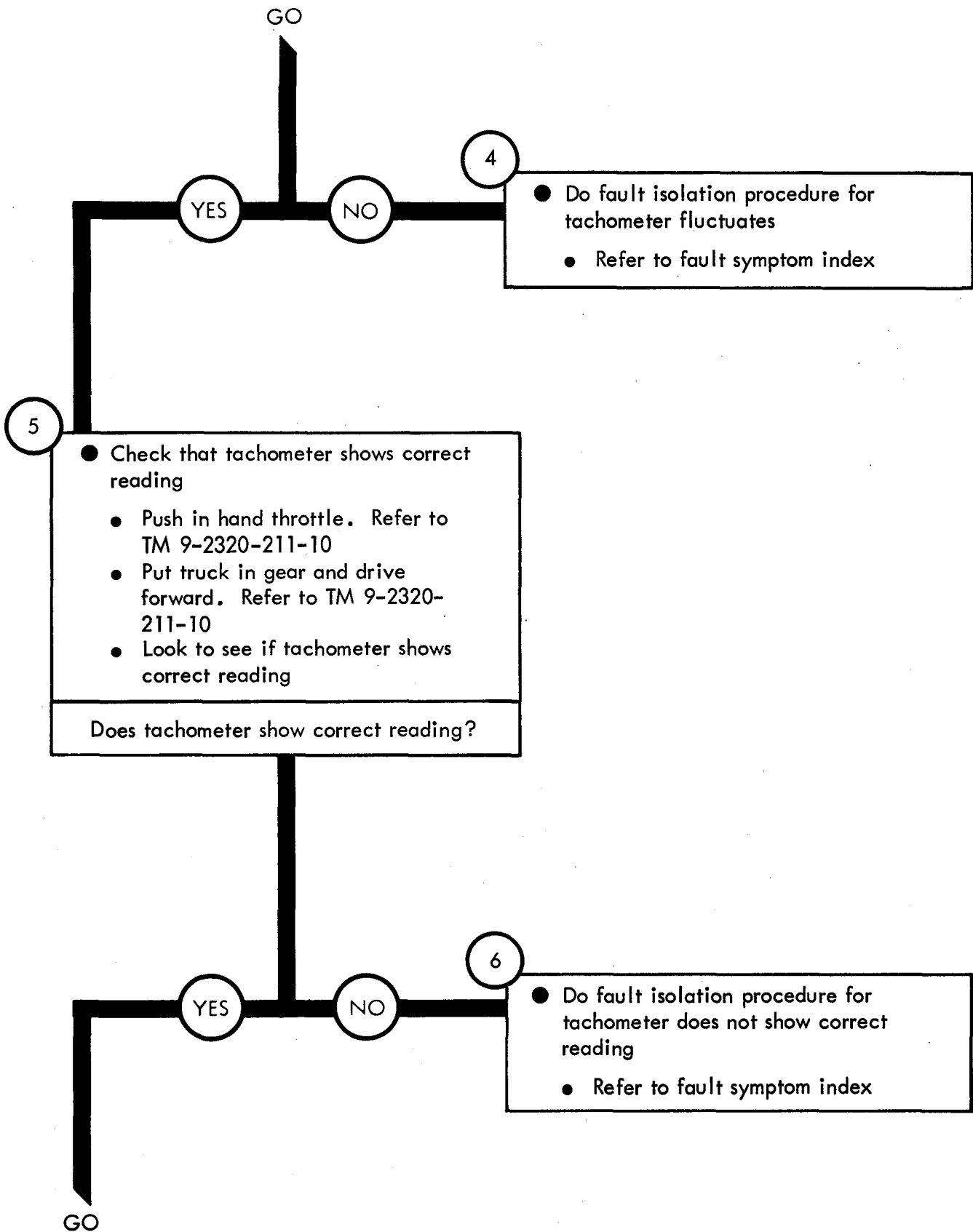

Figure 90-1 (Sheet 2 of 3)

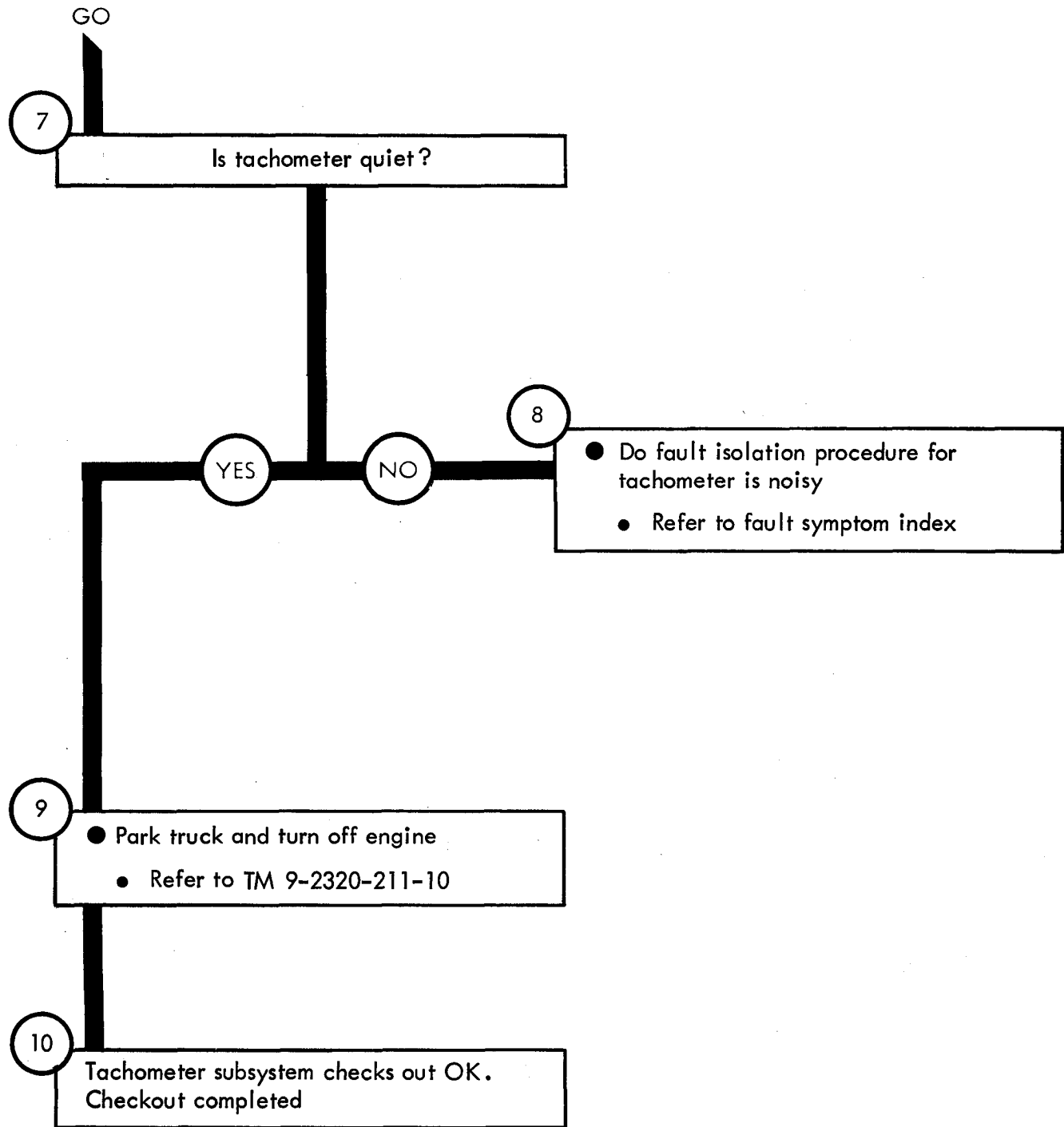

Figure 90-1 (Sheet 3 of 3)

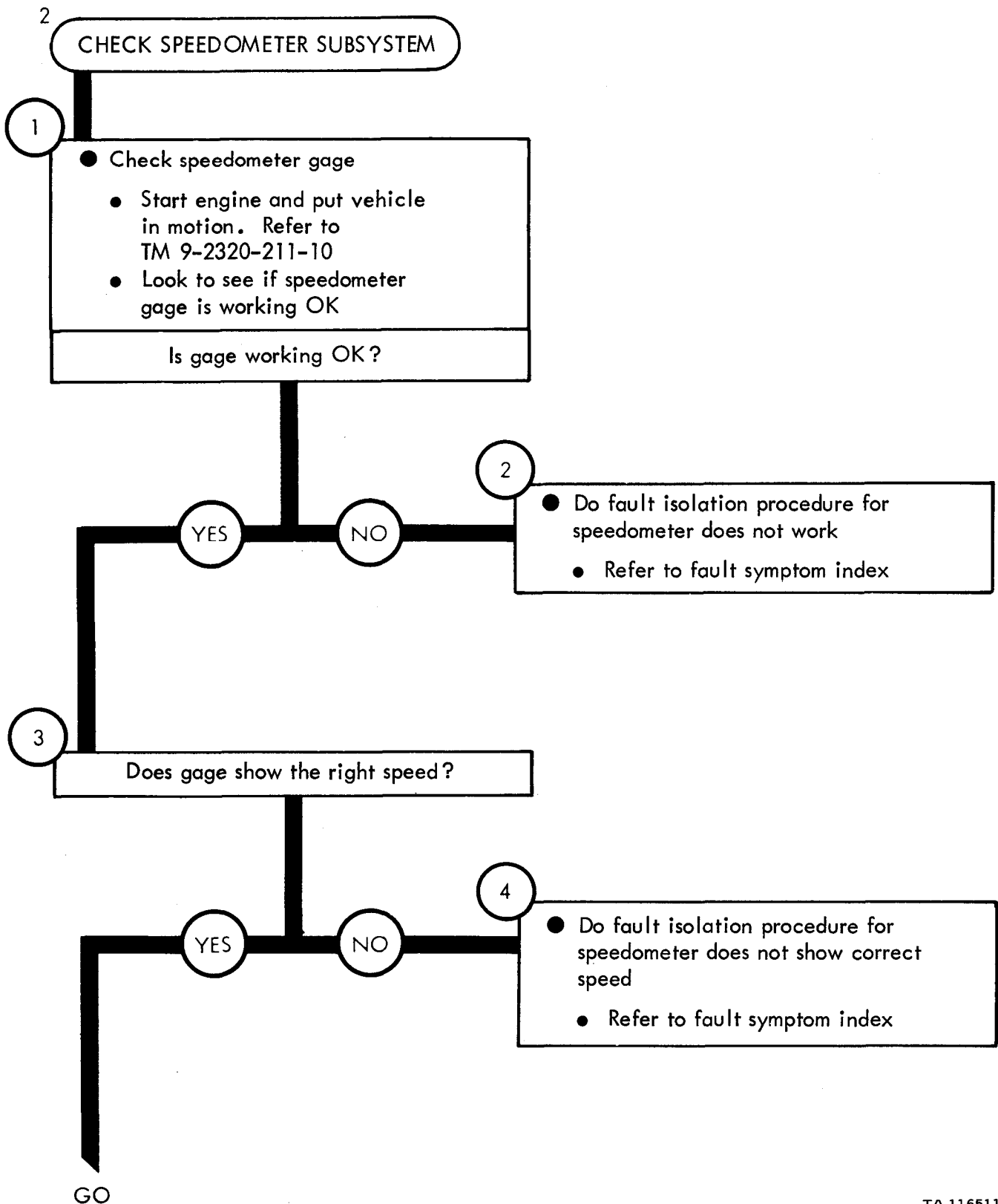

Figure 90-2 (Sheet 1 of 2)

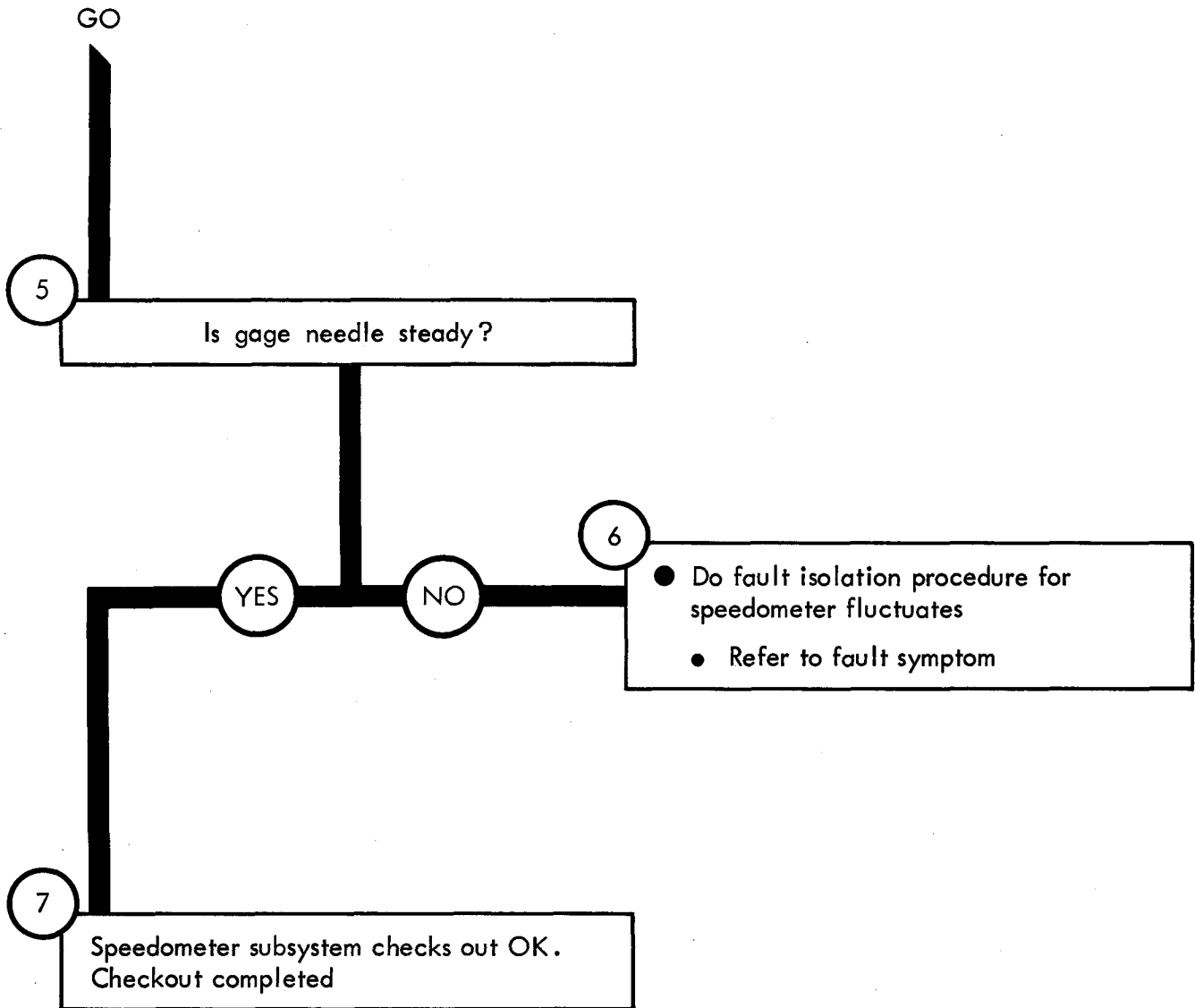
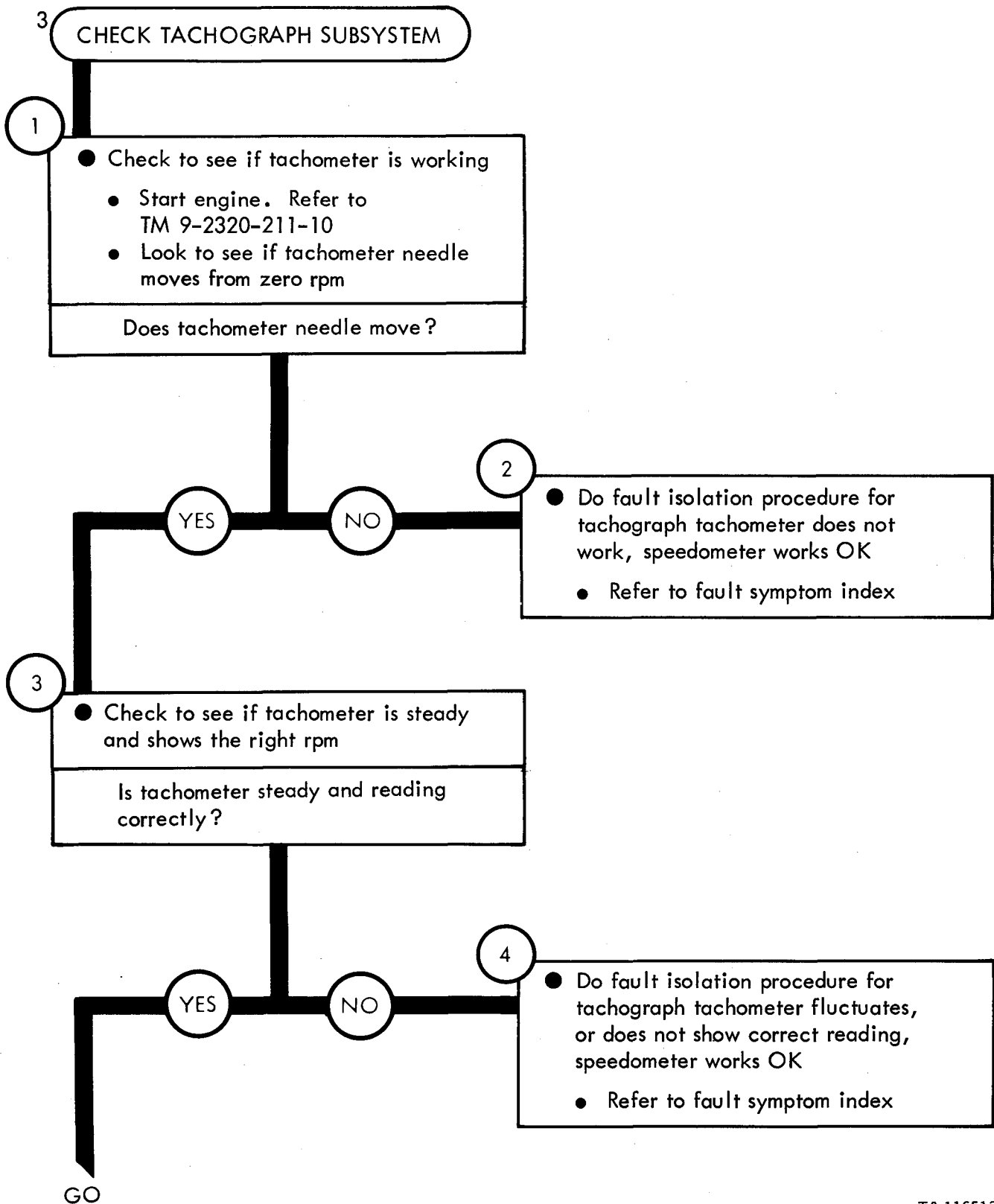
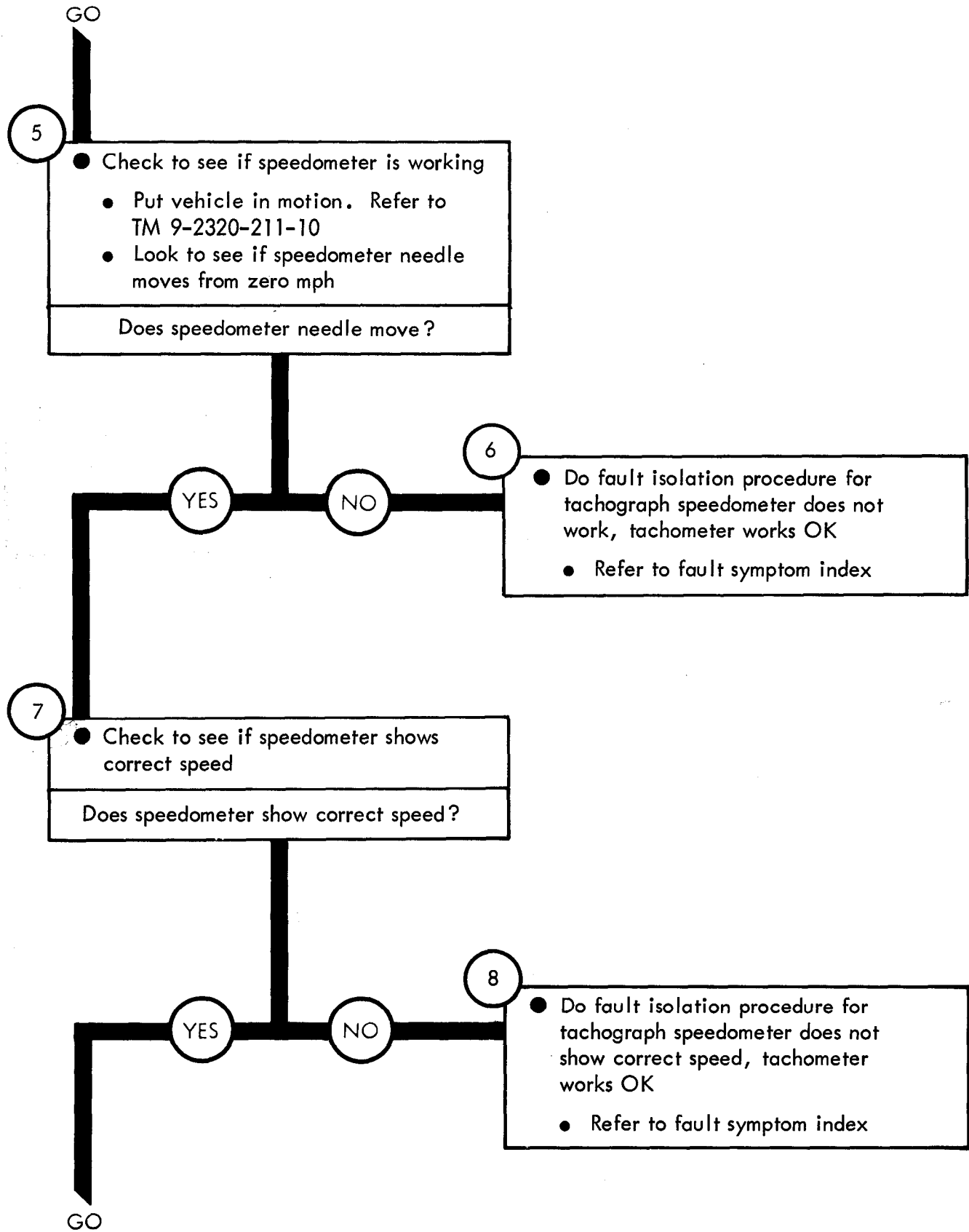

Figure 90-2 (Sheet 2 of 2)



TA 116513

Figure 90-3 (Sheet 1 of 3)



TA 116514

Figure 90-3 (Sheet 2 of 3)

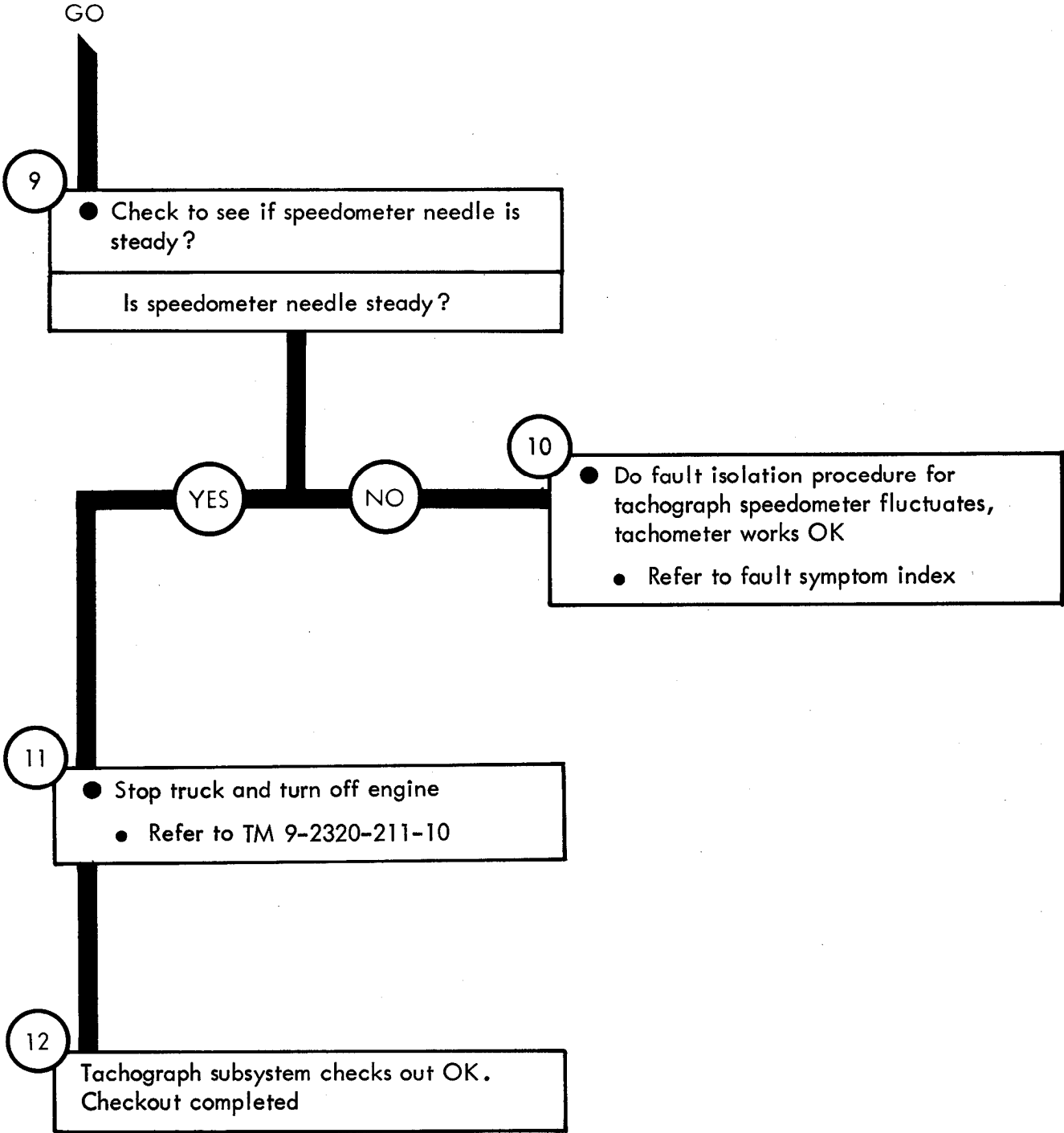

Figure 90-3 (Sheet 3 of 3)

TM 9-2320-211-20-2-2
TO 36A12-1c-422-1-2

By Order of the Secretaries of the Army and the Air Force:

Official:

E. C. MEYER
General, United States Army
Chief of Staff

J. C. PENNINGTON
Major General, United States Army
The Adjutant General

Official:

LEW ALLEN, JR., *General, USAF*
Chief of Staff

VAN L. CRAWFORD, JR., *Colonel, USAF*
Director of Administration

Distribution:

To be distributed in accordance with DA Form 12-38, Organizational maintenance requirements for 5-Ton Trucks, M39 Series.

RECOMMENDED CHANGES TO EQUIPMENT TECHNICAL PUBLICATIONS



THEN... JOT DOWN THE DOPE ABOUT IT ON THIS FORM, CAREFULLY TEAR IT OUT, FOLD IT AND DROP IT IN THE MAIL!

SOMETHING WRONG WITH THIS PUBLICATION?

FROM: (PRINT YOUR UNIT'S COMPLETE ADDRESS)

DATE SENT

PUBLICATION NUMBER

TM 9-2320-211-20-2-2

PUBLICATION DATE

10 Dec 80

PUBLICATION TITLE 5-Ton, 6X6, M39

Series Trucks (Multifuel)

BE EXACT... PIN-POINT WHERE IT IS

PAGE NO.

PARA-GRAPH

FIGURE NO.

TABLE NO.

IN THIS SPACE TELL WHAT IS WRONG AND WHAT SHOULD BE DONE ABOUT IT:

TEAR ALONG PERFORATED LINE

PRINTED NAME, GRADE OR TITLE, AND TELEPHONE NUMBER

SIGN HERE:

FILL IN YOUR
UNIT'S ADDRESS

FOLD BACK

DEPARTMENT OF THE ARMY

OFFICIAL BUSINESS
PENALTY FOR PRIVATE USE \$300

POSTAGE AND FEES PAID
DEPARTMENT OF THE ARMY
DOD 314



Commander
US Army Tank-Automotive
Materiel Readiness Command
ATTN: DRSTA-MB
Warren, MI 48090

RECOMMENDED CHANGES TO EQUIPMENT TECHNICAL PUBLICATIONS



THEN... JOT DOWN THE DOPE ABOUT IT ON THIS FORM, CAREFULLY TEAR IT OUT, FOLD IT AND DROP IT IN THE MAIL!

SOMETHING WRONG WITH THIS PUBLICATION?

FROM: (PRINT YOUR UNIT'S COMPLETE ADDRESS)

DATE SENT

PUBLICATION NUMBER

TM 9-2320-211-20-2-2

PUBLICATION DATE

10 Dec 80

PUBLICATION TITLE 5-Ton, 6X6, M39

Series Trucks (Multifuel)

BE EXACT... PIN-POINT WHERE IT IS

PAGE NO.

PARA-GRAPH

FIGURE NO.

TABLE NO.

IN THIS SPACE TELL WHAT IS WRONG AND WHAT SHOULD BE DONE ABOUT IT:

TEAR ALONG PERFORATED LINE

PRINTED NAME, GRADE OR TITLE, AND TELEPHONE NUMBER

SIGN HERE:

DA FORM 2028-2
1 JUL 79

PREVIOUS EDITIONS ARE OBSOLETE.

P.S.—IF YOUR OUTFIT WANTS TO KNOW ABOUT YOUR RECOMMENDATION MAKE A CARBON COPY OF THIS AND GIVE IT TO YOUR HEADQUARTERS.

FILL IN YOUR
UNIT'S ADDRESS

FOLD BACK

DEPARTMENT OF THE ARMY

OFFICIAL BUSINESS
PENALTY FOR PRIVATE USE \$300

POSTAGE AND FEES PAID
DEPARTMENT OF THE ARMY
DOD 314



Commander
US Army Tank-Automotive
Materiel Readiness Command
ATTN: DRSTA-MB
Warren, MI 48090

TEAR ALONG PERFORATED LINE

RECOMMENDED CHANGES TO EQUIPMENT TECHNICAL PUBLICATIONS



THEN... JOT DOWN THE DOPE ABOUT IT ON THIS FORM, CAREFULLY TEAR IT OUT, FOLD IT AND DROP IT IN THE MAIL!

SOMETHING WRONG WITH THIS PUBLICATION?

FROM: (PRINT YOUR UNIT'S COMPLETE ADDRESS)

DATE SENT

PUBLICATION NUMBER

TM 9-2320-211-20-2-2

PUBLICATION DATE

10 Dec 80

PUBLICATION TITLE 5-Ton, 6X6, M39

Series Trucks (Multifuel)

BE EXACT... PIN-POINT WHERE IT IS

PAGE NO.

PARA-GRAPH

FIGURE NO.

TABLE NO.

IN THIS SPACE TELL WHAT IS WRONG AND WHAT SHOULD BE DONE ABOUT IT:

TEAR ALONG PERFORATED LINE

PRINTED NAME, GRADE OR TITLE, AND TELEPHONE NUMBER

SIGN HERE:

DA FORM 1 JUL 79 2028-2

PREVIOUS EDITIONS ARE OBSOLETE.

P.S.-IF YOUR OUTFIT WANTS TO KNOW ABOUT YOUR RECOMMENDATION MAKE A CARBON COPY OF THIS AND GIVE IT TO YOUR HEADQUARTERS.

FILL IN YOUR
UNIT'S ADDRESS

FOLD BACK

DEPARTMENT OF THE ARMY

OFFICIAL BUSINESS
PENALTY FOR PRIVATE USE \$300

POSTAGE AND FEES PAID
DEPARTMENT OF THE ARMY
DOD 314



Commander
US Army Tank-Automotive
Materiel Readiness Command
ATTN: DRSTA-MB
Warren, MI 48090

THE METRIC SYSTEM AND EQUIVALENTS

LINEAR MEASURE

1 Centimeter = 10 Millimeters = 0.01 Meters = 0.3937 Inches
 1 Meter = 100 Centimeters = 1000 Millimeters = 39.37 Inches
 1 Kilometer = 1000 Meters = 0.621 Miles

SQUARE MEASURE

1 Sq Centimeter = 100 Sq Millimeters = 0.155 Sq Inches
 1 Sq Meter = 10,000 Sq Centimeters = 10.76 Sq Feet
 1 Sq Kilometer = 1,000,000 Sq Meters = 0.386 Sq Miles

WEIGHTS

1 Gram = 0.001 Kilograms = 1000 Milligrams = 0.035 Ounces
 1 Kilogram = 1000 Grams = 2.2 Lb
 1 Metric Ton = 1000 Kilograms = 1 Megagram = 1.1 Short Tons

CUBIC MEASURE

1 Cu Centimeter = 1000 Cu Millimeters = 0.06 Cu Inches
 1 Cu Meter = 1,000,000 Cu Centimeters = 35.31 Cu Feet

LIQUID MEASURE

1 Milliliter = 0.001 Liters = 0.0338 Fluid Ounces
 1 Liter = 1000 Milliliters = 33.82 Fluid Ounces

TEMPERATURE

$5.9 (^{\circ}\text{F} - 32) = ^{\circ}\text{C}$
 212^o Fahrenheit is equivalent to 100^o Celsius
 90^o Fahrenheit is equivalent to 32.2^o Celsius
 32^o Fahrenheit is equivalent to 0^o Celsius
 $9.5 \text{ C}^{\circ} + 32 = \text{F}^{\circ}$

APPROXIMATE CONVERSION FACTORS

<u>TO CHANGE</u>	<u>TO</u>	<u>MULTIPLY BY</u>
Inches	Centimeters	2.540
Feet	Meters	0.305
Yards	Meters	0.914
Miles	Kilometers	1.609
Square Inches	Square Centimeters	6.451
Square Feet	Square Meters	0.093
Square Yards	Square Meters	0.836
Square Miles	Square Kilometers	2.590
Acres	Square Hectometers	0.405
Cubic Feet	Cubic Meters	0.028
Cubic Yards	Cubic Meters	0.765
Fluid Ounces	Milliliters	29.573
Pints	Liters	0.473
Quarts	Liters	0.946
Gallons	Liters	3.785
Ounces	Grams	28.349
Pounds	Kilograms	0.454
Short Tons	Metric Tons	0.907
Pound-Feet	Newton-Meters	1.356
Pounds per Square Inch	Kilopascals	6.895
Miles per Gallon	Kilometers per Liter	0.425
Miles per Hour	Kilometers per Hour	1.609
<u>TO CHANGE</u>	<u>TO</u>	<u>MULTIPLY BY</u>
Centimeters	Inches	0.394
Meters	Feet	3.280
Meters	Yards	1.094
Kilometers	Miles	0.621
Square Centimeters	Square Inches	0.155
Square Meters	Square Feet	10.764
Square Meters	Square Yards	1.196
Square Kilometers	Square Miles	0.386
Square Hectometers	Acres	2.471
Cubic Meters	Cubic Feet	35.315
Cubic Meters	Cubic Yards	1.308
Milliliters	Fluid Ounces	0.034
Liters	Pints	2.113
Liters	Quarts	1.057
Liters	Gallons	0.264
Grams	Ounces	0.035
Kilograms	Pounds	2.205
Metric Tons	Short Tons	1.102
Newton-Meters	Pound-Feet	0.738
Kilopascals	Pounds per Square Inch	0.145
Kilometers per Liter	Miles per Gallon	2.354
Kilometers per Hour	Miles per Hour	0.621

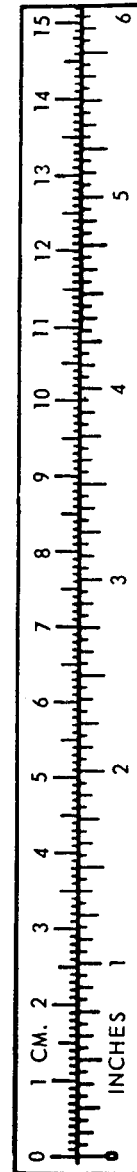

TA089991

